

HP 83621A/31A/51A Synthesized Sweepers Troubleshooting Manual

SERIAL NUMBERS

This manual applies to any synthesized sweeper with the following model number and serial number prefix combinations. You may have to modify this manual so that it applies *directly* to your instrument version. Refer to the "Instrument History" chapter.

HP 83621A/31A	HP 83651A
3317A	3317A
3245A	3245A
3213A	3213A
3143A	3143A
3139A	3137A
3137A	3044A
3104A	
3108A	
3103A	



Agilent Technologies

HP Part No. 08360-90048
Printed in USA April 1993

Edition 4

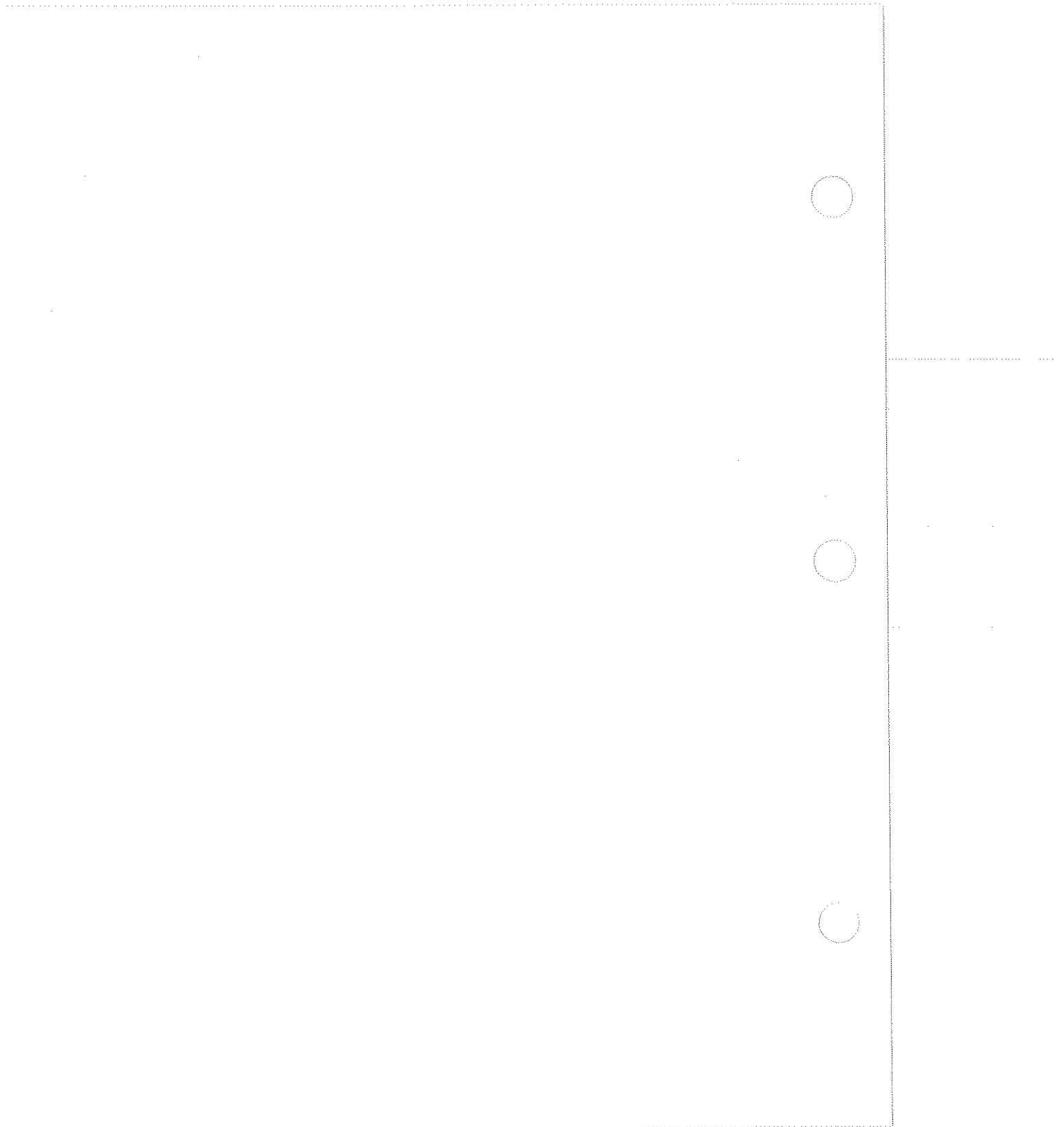

Certification

Hewlett-Packard Company certifies that this product met its published specifications at the time of shipment from the factory. Hewlett-Packard further certifies that its calibration measurements are traceable to the United States National Institute of Standards and Technology (NIST, formerly NBS), to the extent allowed by the Institute's calibration facility, and to the calibration facilities of other International Standards Organization members.

Warranty

This Hewlett-Packard instrument product is warranted against defects in material and workmanship for a period of one year from date of delivery. During the warranty period, Hewlett-Packard Company will, at its option, either repair or replace products which prove to be defective.

For warranty service or repair, this product must be returned to a service facility designated by HP. Buyer shall prepay shipping charges to HP and HP shall pay shipping charges to return the product to Buyer. However, Buyer shall pay all shipping charges, duties, and taxes for products returned to HP from another country.

LIMITATION OF WARRANTY

The foregoing warranty shall not apply to defects resulting from improper or inadequate maintenance by Buyer, Buyer-supplied software or interfacing, unauthorized modification or misuse, or operation outside of the environmental specifications for the product, or improper site preparation or maintenance.

NO OTHER WARRANTY IS EXPRESSED OR IMPLIED, HP SPECIFICALLY DISCLAIMS THE IMPLIED WARRANTIES OR MERCHANTABILITY AND FITNESS FOR A PARTICULAR PURPOSE.

EXCLUSIVE REMEDIES

THE REMEDIES PROVIDED HEREIN ARE BUYER'S SOLE AND EXCLUSIVE REMEDIES. HP SHALL NOT BE LIABLE FOR ANY DIRECT, INDIRECT, SPECIAL, INCIDENTAL, OR CONSEQUENTIAL DAMAGES, WHETHER BASED ON CONTRACT, TORT, OR ANY OTHER LEGAL THEORY.

Assistance

Product maintenance agreements and other customer assistance agreements are available for Hewlett-Packard Products.

For any assistance, contact your nearest Hewlett-Packard Sales and Service Office. Addresses are provided at the back of this manual.

Troubleshooting

How to Use This Chapter

Menus If you are not familiar with the menus in this instrument, go to the “Menus” chapter in the *Service* manual and fold out the service menu map (see the following figure). Use the map for reference as you troubleshoot.

Some menus have more than one page of softkeys. Select the **More** softkey to see the next page of softkeys. **More** is *not* included in the keystrokes given in this chapter.

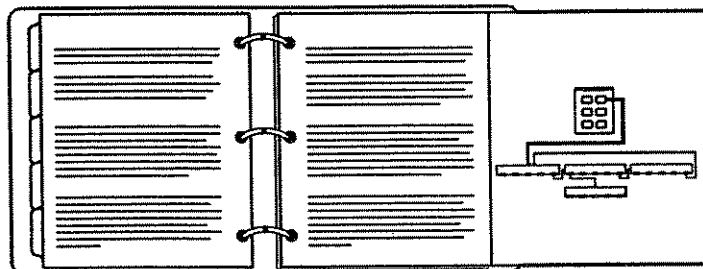

Where to Begin Troubleshooting

Caution



Follow all troubleshooting procedures in the order given. Done out of order, these procedures can miss critical checks. You can waste time, and possibly replace the wrong assembly.

Begin with “Instrument-Level Troubleshooting”. This section directs you to the appropriate troubleshooting module.

Troubleshooting Modules

These modules pictorially guide you through the required measurement steps (see the following example). Each module covers one or more assemblies, and isolates a problem to the assembly level.

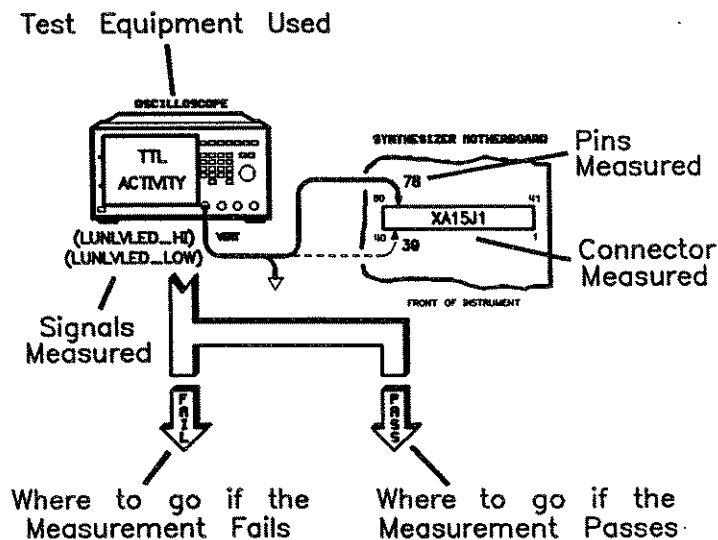

Special Cases

This section covers problems not isolated in the troubleshooting modules. “Special Cases” also contains an instrument block diagram.

Troubleshooting Foldout

The troubleshooting foldout, referenced in the troubleshooting modules, is located just prior to the “Special Cases” tab.

Equipment Required

Table 1-1 lists recommended troubleshooting equipment. You may use any equipment that meets the critical specifications listed.

Instruments Without a Front Panel Keyboard

If your instrument does not have a keyboard, there are two ways you can troubleshoot it:

1. Use the front panel emulation software, as instructed in instrument-level troubleshooting. The software itself is documented in the “Automated Tests” chapter of the *Service* manual.
2. Use a substitute front panel (to order, see “Replaceable Parts”, in the *Service* manual).

Lifting the RF Deck Up Into the Service Position

In some of the troubleshooting procedures you will be required to lift the RF deck up into the service position. Instructions for this procedure are documented in the “Disassembly & Replacement Procedures” chapter in the *Service* manual as part of the “RF Deck Disassembly & Reassembly” procedure.

Table 1-1. Recommended Troubleshooting Equipment

Instrument	Critical Specifications	Recommended HP Model or PN
Digital Voltmeter	Range: -50 to +50 Vdc Accuracy: $\pm 0.01\%$ Input Impedance: $\geq 10\text{ M}\Omega$	3456A 3457A
Frequency Counter ¹	Range: 0.01 to 26.5 GHz Accuracy: Time base ± 1 count Aging Range 5×10^{-10}	5343A
Function Generator	Sine Wave Amp: $\geq 1\text{ V rms}$ Sine Wave Freq: dc to 100 kHz	3325A
Oscilloscope	Dual Channel Bandwidth: dc to 300 MHz Vert Sensitivity: $\leq 5\text{ mV/Div}$ Horiz Sensitivity: 50 ns/Div 10 Magnifier Trigger: Event Triggerable	54111D 54110D
Oscilloscope Probes		10033A
Power Meter ¹	Power Range: $1\ \mu\text{W}$ to 100 mW Accuracy: $\pm 0.01\%$	436A 437B 438A
Power Sensor	0.01 to 0.05 GHz 0.05 to 26.5 GHz 0.05 to 50 GHz	8481A 8485A 8487A
Service Accessory Kit ²		08360-60060

¹ May be replaced by a spectrum analyzer.

² For ordering information, see "Replaceable Parts" in the *Service manual*.

Instrument Level Troubleshooting

ILT.000 Begin Troubleshooting

Follow the instructions in this section in the order given. The equipment required to troubleshoot the synthesizer is listed in table 1-1, in the introduction to troubleshooting. You may use any equipment that meets the critical specifications listed.

Go to paragraph ILT.100

ILT.100

Can you safely connect the instrument to line power?



Go To A16.000

Continue

ILT.101

Turn on line power and make the following observations *during* power up:

- The amber standby light goes off.
- The green power-on light comes on.
- The fan operates. Because the fan is very quiet, you may need to feel for airflow.

Is line power on and does the unit appear safe to operate?



Go To A16.000

Continue

Does the amber standby light go off, the green power-on light come on, and the fan operate?



Go To A16.000

Continue

ILT.102 Does the synthesizer have a front panel with a display and keyboard?

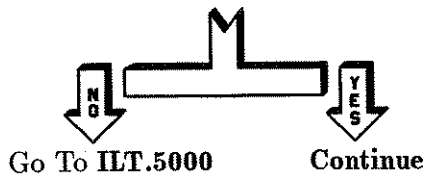

ILT.103 Enable factory preset:
1. Press SYSTEM **MENU**.
2. Select **Preset Mode Factory**.
3. Press **PRESET**.

Could you complete the factory preset?

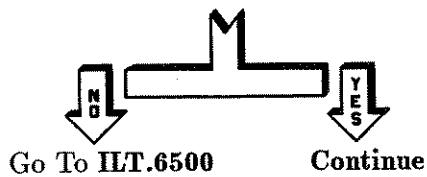

ILT.104 Press **PRESET**.

Start(MHz)	Stop(MHz)	Power(dBm)
10.000000	20000.000000	INT: 0.00

Compare the synthesizer display to the figure shown. Stop and start frequencies may vary depending on the synthesizer model number. Also, flashing messages may appear on the front panel. These messages include (but are not limited to) OVEN, UNLOCK, LOW UNLVLED, and OVRMOD. Do not consider these messages failures at this time.

Is the display correct?

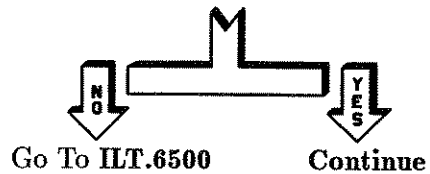

ILT.105 Ensure that all external cables are removed from the synthesizer and then perform a full self-test:

1. Press **SERVICE**.
2. Select **Selftest (Full)**.
3. Wait about 1 minute for self-tests to run.

Continue with paragraph ILT.106.

ILT.106

```
**** ALL SELF-TESTS HAVE PASSED ! ****  
No failures were found in any of the  
tests on the self-test list.
```

```
Abort          ....Options....  
                Loop   Log   Cont
```

At the end of self-test, if the display shows ALL SELF-TESTS HAVE PASSED ! continue with ILT.107. Otherwise, follow the directions displayed on the synthesizer.

- ILT.107** Were the self-tests run to confirm correct operation of the synthesizer? For example, were self-tests run after a repair, as a periodic check, or as part of a calibration?

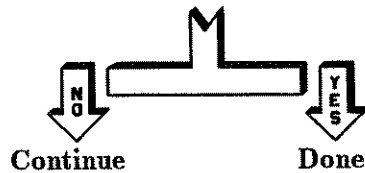

- ILT.108** Does the synthesizer have a front panel with a display and keyboard, and do you want to test the display and keyboard?

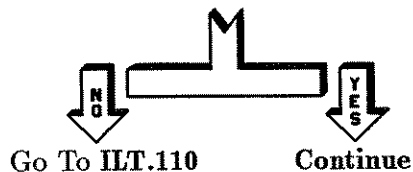

Test the display by running self-test #257:

1. Press **PRESET** **SERVICE**.
2. Select **Selftest Menu**.
3. Press **257** **ENTER**.
4. Select **Do Test #257**. To exit the test, press **PRESET**.

Do marching characters and a fast-moving cursor (-) appear on the display?

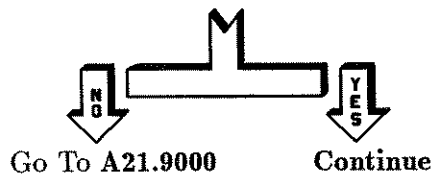

ILT.109 Test the keyboard by running self-test #21:

1. Press **SERVICE**.
2. Select **Selftest Menu**.
3. Press **21** **ENTER**.
4. Select **Do Test #21**.
5. Turn the rotary knob on the front panel clockwise and counter clockwise.

Do an X and a dash (-) flash in the upper right corner of the display?



Go To **ILT.6000** **Continue**

Press all keys on the front panel *except* **PRESET**.

Do all dashes (-) change to Xs?



Go To **A1.9000** **Continue**

ILT.110 If a password is set, you must know it to do this step.

View calibration constant #463 (hardware configuration):

1. Press **PRESET** **SERVICE**.
2. Select **Adjust Menu**.
3. If **ENTER PASSWORD: 0** appears on the top line of the display:
 - a. Enter the password.
 - b. Press **ENTER**.
 - c. Select **Adjust Menu**.

4. Select **Calib Menu** **Select Cal.**
5. Press **463** **ENTER**.
6. Note the value of calibration constant #463.
Compare it to the following list.
HP83621A: 30864
HP83631A: 30864
HP83651A: 32176

Is the synthesizer hardware configuration number correct?

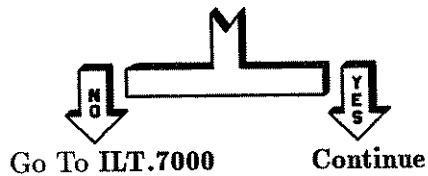

ILT.111 Does the synthesizer have a user preset implemented?

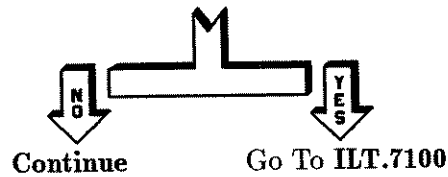

ILT.112 Were self-tests run because an adjustment failed?

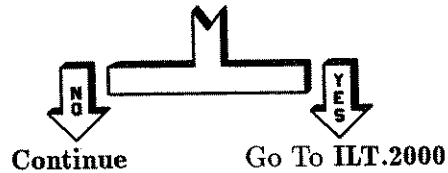

ILT.113 If a **FAULT** message is displayed, check the Fault Menu. Does a **RAMP** fault exist?

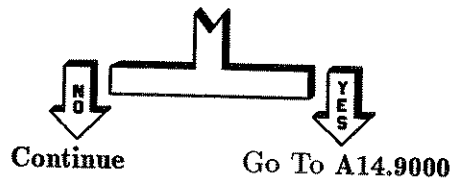

ILT.114 Perform the following calibration:

1. Press **PRESET** **USER CAL**.
2. Select **FullUsr Cal**.
3. Wait for the calibration to complete (≤ 1 minute).

If the calibration runs without errors, continue with **ILT.115**. Otherwise, go to performance tests and adjustments.

ILT.115 Were self-tests run because of a faulty signal at one or more of the I/O ports listed below?

* Display Out	* Keyboard In
* HP-IB In/Out	* 10 MHz Ref In
* 10 MHz Ref Out	* Trigger In
* Sweep Out	* Stop Sweep In/Out
* External ALC In	* Front Panel SMI
* RF Out	* Trigger Out
* Auxiliary Int	* HP-IB Switches



ILT.116 Do *all* of the following work properly?

- Power level functions:
 - RF on/off.
 - Power sweep.
 - Power slope.
 - Attenuator uncoupling.
 - Up/down power size.
- Setting frequencies (start, stop, CW, etc.):
 - Up/down size.
 - Frequency offset.
 - Frequency multiplier.
- Marker functions.
- Sweep functions:
 - List.
 - Step:
 - Step size.
 - Step points.
 - Step dwell.
 - Step sweep trigger.
 - Sweep ramp.
- Frequency list.
- Fast sweep time (≤ 100 ms sweep time).
- Slow sweep time (≥ 5 s sweep time).
- Single sweep or manual sweep.
- Trigger sweep.
- Trigger out delay.
- Save/recall registers.

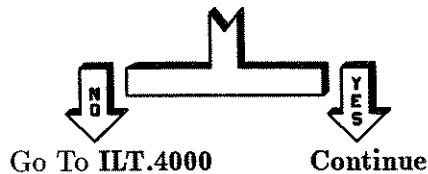

ILT.117 Did one or more of the following performance tests fail (or do you believe they would have)?

* Internal Timebase Aging Rate	* Power Accuracy
* Frequency Switching Time	* CW Frequency Accuracy
* Power Flatness	* Maximum Leveled Power
* External Leveling	* Swept Frequency Accuracy
* Single Sideband Phase Noise	* Spurious Signals (Line Related)
* Spurious Signals (Harmonics)	* Spurious Signals (Non-Harmonics)

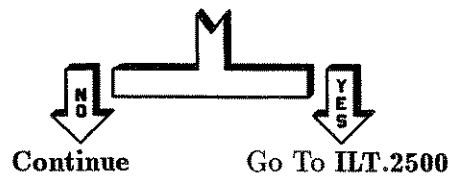

ILT.118 Were self-tests run because of a failure associated with a source module?

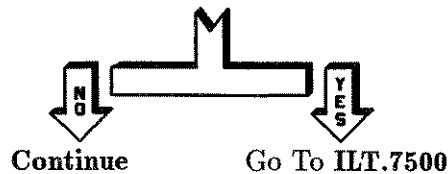

ILT.119 Were self-tests run because of a network or scalar analyzer system failure?

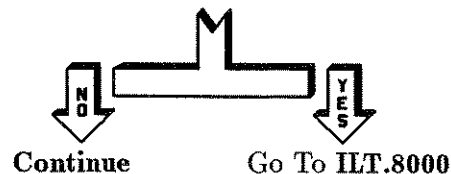

ILT.120 Are all failures gone?

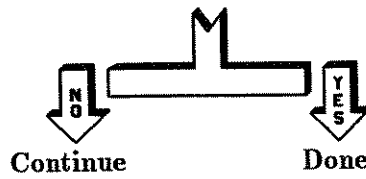

ILT.121 You have encountered a problem not dealt with by these procedures. Consult "Special Cases" to troubleshoot this problem.

ILT.2000

Select the failing adjustment and go to the indicated paragraph.

Failed Adjustment	Go to Paragraph
ADC Calibration	A15.9000
10 MHz Standard	A23.000
Fractional-N VCO	A4.9000
Fractional-N Reference and API Spurs	A4.9000
Sweep Ramp	A14.9000
YO Driver +10V Reference	A13.9000
Sampler Assembly	ILT.2010
YO Loop Gain	A5.9000
YO Driver Gain and Linearity	ILT.2030
YO Delay	ILT.2030
Modulator Offset and Gain	ILT.2110
Power Flatness	ILT.2240
ALC Power Level Accuracy	ILT.2240
Amplifier/Multiplier Adjustments	RF.2890
Amplifier/Filter Adjustments	RF.2990
Low Power SRD Bias	RF.2890
Square Wave Symmetry	A9.9000

ILT.2010 Set up for power measurement:

1. Set the power switch to STANDBY.
2. Remove the top and bottom covers.
3. Turn the synthesizer power on.
4. Press **PRESET** **CW** **SERVICE**.
5. Select **Tools Menu** **Cnt1PLL Menu** **NoPhaseLock** (asterisk on).
6. Select **LoopCnt1 Menu** **Y0 Loop Freq.**
7. Press **2** **GHz**.
8. Using the rotary knob, sweep the frequency from 2 to 7 GHz and verify that power is greater than -25 dBm.

Set up for frequency measurement:

1. Press **2** **GHz**.
2. Using **▲**, increment the frequency.
3. The measured frequency equals the front panel indication ± 40 MHz (2 to 7 GHz).

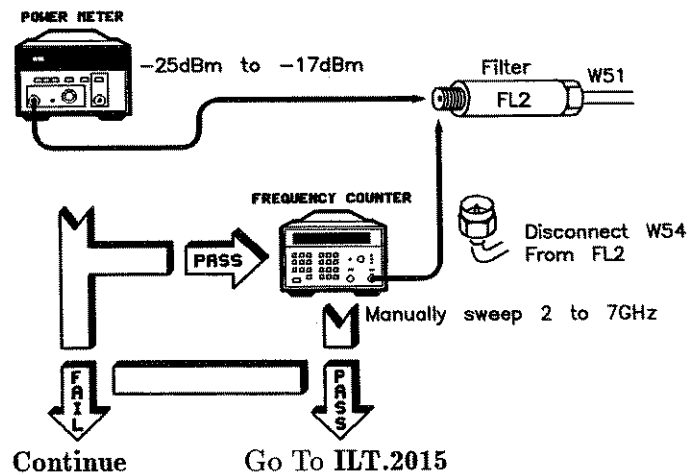

ILT.2011 Set up for power measurement:

1. Reconnect any disconnected cables.
2. Put the RF deck in the service position.
3. Remove W51 which connects the directional coupler (A39) to the 20 dB attenuator (AT3).
4. Press **PRESET** **CW** **SERVICE**.
5. Select **Tools Menu** **CntlPLL Menu** **NoPhaseLock** (asterisk on).
6. Select **LoopCnt1 Menu** **Y0 Loop Freq.**
7. Press **2** **GHz**.
8. Using the rotary knob, sweep the frequency from 2 to 7 GHz and verify that power is ≥ -24.5 dBm.

Set up for frequency measurement:

1. Press **2** **GHz**.
2. Using **▲**, increment the frequency.
3. The measured frequency equals the front panel Indication ± 40 MHz (2 to 7 GHz).

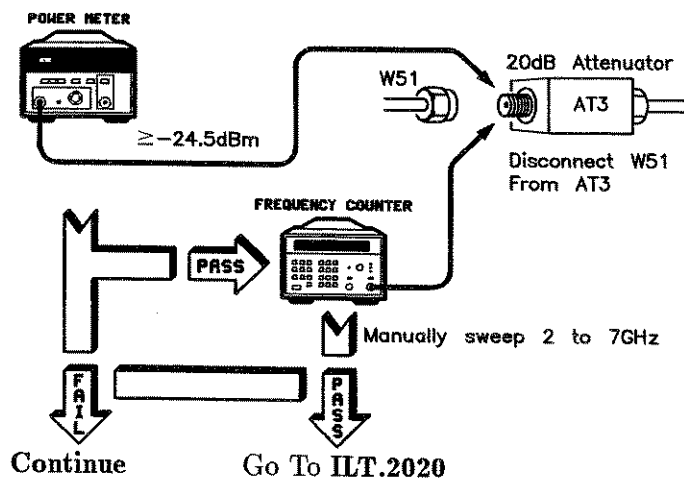

ILT.2012 Set up for power measurement:

1. Reconnect any disconnected cables.
2. Put the RF deck in the service position.
3. Remove W52 (connects the YIG oscillator, A26, to the directional coupler (A39)).
4. Press **PRESET** **CW** **SERVICE**.
5. Select **Tools Menu** **Cnt1PLL Menu** **NoPhaseLock** (asterisk on).
6. Select **LoopCnt1 Menu** **Y0 Loop Freq.**
7. Press **2** **GHz**.
8. Using the rotary knob, sweep the frequency from 2 to 7 GHz and verify that power is ≥ 8 dBm.

Set up for frequency measurement:

1. Press **2** **GHz**.
2. Using **▲**, increment the frequency.
3. The measured frequency equals the front panel indication ± 40 MHz (2 to 7 GHz).

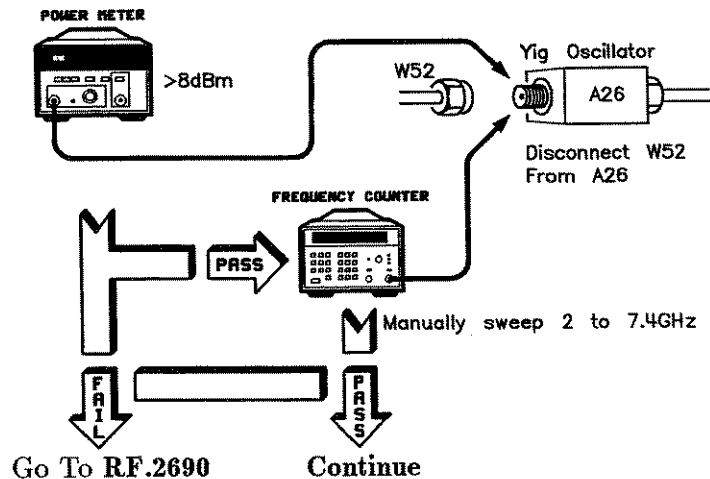

ILT.2013 Check W52 for damage, deformation, or excessive RF path loss.

Is W52 defective?



Go To **RF.2590** **Continue**

Replace W52 and go to the Troubleshooting Foldout, block 1 (located just prior to the “Special Cases” tab).

ILT.2015 Remove A6 from the synthesizer and disconnect W54 from A6. Inspect and test W54 for defects.

Is W54 defective?



Go To **A6.9000** **Continue**

Replace W54 and go to the Troubleshooting Foldout, block 1 (located just prior to the “Special Cases” tab).

ILT.2020 There is a high-loss path between the directional coupler (A39) and the sampler (A6). This path includes two hard lines (W54 and W51), a low pass filter (FL2), and a 20 dB attenuator (AT3). The most likely failure is a poor connection. Correct the faulty connection or replace the faulty part (W54, FL2, W51). A less likely option is that the 20 dB attenuator (AT3) is faulty. Isolate and replace the faulty component and go to the Troubleshooting Foldout, block 1 (located just prior to the “Special Cases” tab).

To check for excessive loss in a cable, filter, or attenuator, connect the component input to a

known-good signal for the frequency bands in question (see the block diagram at the end of "Special Cases") and test the output. Over the frequency range of 2.0 to 8.0 GHz, the loss for a coaxial cable should be ≤ 2.0 dB; the loss for a filter should be ≤ 4.0 dB and the loss of the 20 dB attenuator should be 20 dB.

ILT.2030 The most likely cause of this failure is A26, the YIG oscillator (go to RF.2690.) If replacing A26 does not resolve the problem, it is possible (but less likely) that A13, the YO driver assembly could be the cause. Go to A13.9000 to replace A13.

ILT.2110 Does the adjustment (modulator offset and gain) fail above 2 GHz?



ILT.2111 Does the adjustment (modulator offset and gain) fail below 2 GHz?

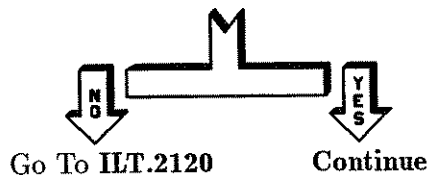

ILT.2112 The problem is most likely the A10 assembly (it is possible, however, that A24 and A38 are both faulty). First go to paragraph A10.9000. If this does not fix the problem, consider RF.2490, and/or RF.3890.

ILT.2115 The problem is most likely either the A24 or the RF cables connected to A24. It is possible, however, that the A10 assembly may be the problem.

If A24 has *not* been replaced, go to RF.2490, otherwise go to A10.9000.

ILT.2120 The problem is most likely either A38 or the RF cables connected to A38. It is possible, however, that the A10 assembly may be the problem.

If A38 has *not* been replaced, go to RF.3890, otherwise go to A10.9000.

ILT.2130 The most likely cause of this problem is the A10 assembly. If this assembly has not been replaced, go to A10.9000. If this assembly has been replaced, consider changing the AM modulator (RF.3890). Or, if the problem exists only in low band, try changing low band (RF.2490).

ILT.2240 The most common problem with RF power is loose or damaged connectors and coax cables (especially hard lines on the RF deck). If the instrument has sudden drops in power above 10 GHz, check for faulty connections. Check all hard lines, making sure that none of the cables are cross-threaded, canted, or damaged. Check all connections from the YO (A26) to the RF OUTPUT connector (J1).

Are all connections and cables good?

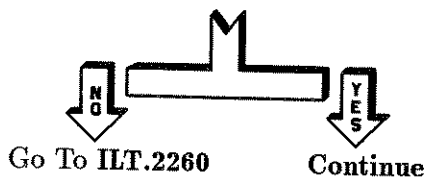

ILT.2241 Does the instrument have low band (≤ 2 GHz), and does the RF power problem exist only in low band?



Go To **ILT.2245** **Continue**

ILT.2242 The problem is most likely the low band microcircuit (A24). A less likely possibility is the amplifier/multiplier (A28) in the HP 83621A/31A or the doubler (A32) in the HP 83651A. Before continuing, check again for loose or poorly seated connectors.

Has A24 been previously replaced?



Go To **RF.2490** Go To **ILT.2257**

ILT.2245 Does the RF power problem exist *only* at frequencies ≥ 2 GHz?



Go To **ILT.2256** **Continue**

ILT.2246 Is the synthesizer upper frequency limit 50 GHz?



Go To **ILT.2255** **Continue**

- ILT.2247** Does the RF power problem exist *only* when the A32 doubler is active (> 26.5 GHz for instruments with an upper frequency limit of 50 GHz)?

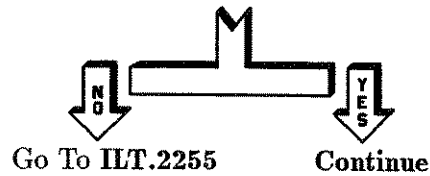

- ILT.2248** Loose connections or bad RF cabling can easily cause problems at these frequencies. Check all cabling from the amplifier/multiplier (A28) to the RF OUTPUT (J1). If all RF cabling appears intact, the most probable cause is the amp/doubler (A32).

Are the cabling and J1 intact?

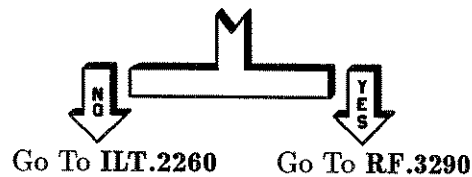

- ILT.2255** The most probable fault is a loose cable between A30 and the RF OUTPUT connector. Use the block diagram to guide you in checking power levels between A30 and the RF OUTPUT connector. Then use the block diagram to check the following items.

1. The RF OUTPUT connector.
2. The bridge detector (RF.3090).
3. The low power adjustment.
4. For *abrupt power drop out only*, amplifier/multiplier adjustments.
5. The amplifier/multiplier (RF.2890).
6. If present, the amp/switch (RF.3390).
7. The amplifier/filter adjustments.
8. The amplifier filter (RF.2990).

If these alternatives do not fix the problem, use the instrument block diagram (located at the end of "Special Cases") to troubleshoot this problem.

ILT.2256

A general power level problem exists. The assemblies that affect a broad band of frequencies start with the bridge detector, and end with J1. If a power level accuracy problem exists, it is possible that the A10 assembly (ALC) is faulty. There is no easy and effective way to continue testing without additional equipment. The following is a prioritized list of the most probable causes:

1. For power measurement level accuracy only, the A10 assembly (A10.9000).
2. The RF OUTPUT connector.
3. Hard lines between the A30 assembly and the RF OUTPUT connector.
4. The bridge detector (RF.3090).

If these alternatives do not fix the problem, use the instrument block diagram (located at the end of "Special Cases") to troubleshoot this problem.

ILT.2257

The most probable fault is a loose cable between A24 and the RF OUTPUT connector. Use the block diagram to guide you in checking power levels between A30 and the RF OUTPUT connector. Then use the block diagram to check the following items.

1. The RF OUTPUT connector.
2. The amplifier/multiplier (RF.2890) in the HP 83621A/31A and the amp/doubler (RF.3290) in the HP 83651A.
3. The amp doubler (RF.3290).
4. The bridge detector (RF.3090).
5. The amp/doubler (RF.3290) – HP 83651A only.

ILT.2260 Repair, reseal, or reconnect the cables as required and continue with the performance tests or adjustments as required.

ILT.2500 At this point, all adjustments related to the failing performance test should have been successfully completed. Select the first failing performance test and go to the indicated paragraph.

Failing Performance Test	Go to Paragraph
Internal Timebase Aging Rate	A23.000
Frequency Switching Time	ILT.2670
Swept Frequency Accuracy	ILT.2660
Power Flatness	ILT.2695
Power Accuracy	ILT.2695
Maximum Leveled Power	ILT.2695
External Leveling	A10.9000
Spurious Signals (Harmonics)	ILT.2650
Spurious Signals (Line Related)	ILT.2610
Spurious Signals (Non-Harmonics)	ILT.2630
Single Sideband Phase Noise	ILT.2640
CW Frequency Accuracy	ILT.2700

ILT.2610 Line related spurs are spurious signals offset from the carrier by multiples of the line frequency. If, for example, the line frequency is 60 Hz, line related spurs can occur at 60, 120, 180, 240 Hz, and so on. The most prevalent spur is the second harmonic.

The most likely cause of line related spurs is EMI (electromagnetic interference) from other sources or from poor grounding. EMI can occur as a result of

shielding degradation in the synthesizer due to damage or faulty reinstallation of the top or bottom covers, or the braided shielding. A faulty line filter (FL1) can also cause spurs. Recheck the measurement and set up for faulty grounds. Check the synthesizer shielding. Check the environment for unusually strong line currents close to the measurement.

If there is no likely external source, replace FL1. After taking action, go to the Troubleshooting Foldout, block 1 (located just prior to the "Special Cases" tab).

ILT.2620 The problem can be caused by the A10 assembly (ALC) or a microcircuit. Using the table below, go to the indicated paragraphs.

Failing Frequency Range	Go to Paragraph
≤ 2 GHz only	A10.9000 (ALC) or RF.2490 (low band)
≥ 2 GHz only	A10.9000 (ALC) or RF.3890 (AM modulator)
Above <i>and</i> below 2.3 GHz	A10.9000 (ALC)

ILT.2630

There are two types of non-harmonic, non-line related spurious signals (spurs):

- Crossing spurs. These are usually caused by poor shielding, or by interaction between the YO loop phase detector assembly (A5) and the sampler assembly (A6). Another cause is 10 MHz or a harmonic of 10 MHz getting into the sampler assembly. Check shielding, grounds, filtering on the A6 assembly, and cable routing.
- Fixed offset spurs. These are the most common spurs. They appear at a fixed offset from the carrier.

The following table lists the most common offset spurs, the their possible causes.

Note

If the fault is only in low band, the low band microcircuit (A24) is also a possible cause.

Offset from Carrier	Most Likely Fault
60 kHz	Grounds, connections and shielding, A16, A17, A18
120 kHz	A16, A17, A18
20 or 40 kHz	A3, A6 shielding/filtering
125 kHz	A4 API adjustment, shielding, filtering; possibly reference shielding, filtering.
Random Low Frequency	Fan (B1)
10 or 20 MHz	Routing of cables to and from A7.

These problems are very difficult to isolate, and require patience. Often, the quickest and most economical way to isolate a problem is to substitute modules.

After taking action, go to the Troubleshooting Foldout, block 1 (located just prior to the "Special Cases" tab).

ILT.2640

Poor grounds or shielding problems in either the environment or the measurement system can produce what looks like a failure in phase noise measurements. Another common source of phase noise is physical vibration. When you are sure that the measurements accurately reflect a failure, refer to the following graph. Locate the failed frequency on the graph and go to the paragraph shown for that frequency. Note, if your failure is between 100 Hz and 1 kHz, check frequencies above and below the failure. If the frequencies below 100 Hz are failing or are close to failing, go to A7.9000. If the frequencies above 1 kHz are failing or are close to failing, go to A6.9000. In the synthesizer, phase noise is usually concentrated at one of three carrier offsets. Failures of phase noise at these offsets have fairly predictable causes. Before you change a module, check the phase noise measurement system.

Note



If the fault is only in low band, the low band microcircuit (A24) is also a possible cause (RF.2490).

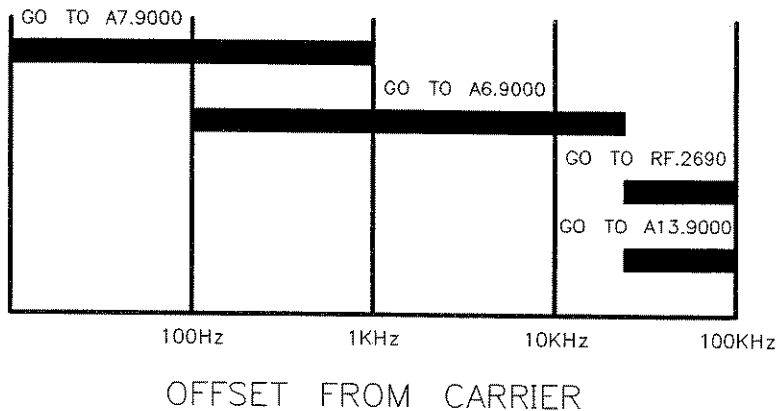

These problems are very difficult to isolate, and require patience. Often, the quickest and most economical way to isolate a problem is to substitute modules.

After taking action go to the Troubleshooting Foldout, block 1 (located just prior to the "Special Cases" tab).

ILT.2650 Perform a full user calibration:

1. Press **USER CAL**.
2. Select **FullUsr Cal**.

If the problem still exists, continue. In general, troubleshoot harmonics using the block diagram. Go from the RF OUTPUT (J1) to each of the active RF devices (A24, A26, A28, A29, A38 and, with options, A32 and A33). Use the ALC menus to help control the

level during a measurement. Pay attention to the bands in which the problem appears. Use the table below to help isolate the problem.

Failing Data Points	Most Likely Causes
≤ 2 GHz only	Low band microcircuit (A24)
> 20.0 GHz	Doubler/amp (A32)
All Other Cases	YO (A26), amp/multiplier (A28), AM modulator (A38), and amp/detector (A29)

After taking action, go to the Troubleshooting Foldout, block 1 (located just prior to the “Special Cases” tab).

ILT.2660 The most likely cause is the YO driver assembly (go to A13.9000), the next possibility is YO assembly (go to RF.2690).

After taking action, go to the troubleshooting foldout, block 1 (located just prior to the “Special Cases” tab).

ILT.2670 The most likely faults are listed below:

1. The most likely fault is the measurement setup.
Check the setup.
2. Check the calibration constants (listed in the *Service manual*). Pay special attention to the following calibration constants:
 - a. Lock dwell time.
 - b. Max phase lock wait.
3. If an unlock message appears, press **PRESET** **SERVICE** **Unlock Info**. The following is a prioritized list. Find the first one that applies.
 - a. REF UNLOCK: go to A7.9000.
 - b. SAMPLER UNLOCK: go to A6.9000.

- c. FRACN UNLOCK: go to A4.9000.
 - d. YO UNLOCK: consider the following, in the order listed.
 - i. A6: go to A6.9000.
 - ii. A5: go to A5.9000.
 - iii. A13: go to A13.9000.
 - iv. A26: go to RF.2690.
 - e. HET UNLOCK: go to RF.2490.
4. The microprocessor may cause the fault, go to A15.9000.

If these alternatives do not fix the problem, use the instrument block diagram (located at the end of "Special Cases") to troubleshoot this problem.

ILT.2695 The diagnostics already performed are probably more accurate than the remaining procedures. These procedures may not be able to identify the failed assembly. This is particularly true when a specification has only marginally failed. Before continuing, verify all RF cable connections on the RF deck. If no problems are found, go to ILT.2240.

ILT.2700

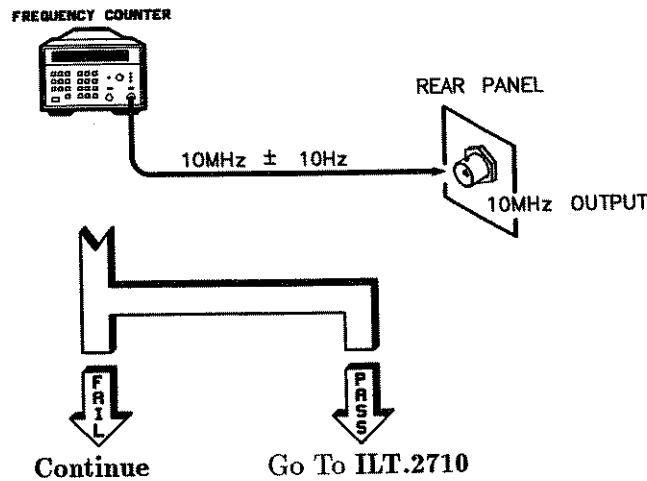

ILT.2701 The 10 MHz standard is out of tolerance. Perform the “10 MHz Standard” adjustment (see the *Service manual*). If the 10 MHz output is still out of tolerance after performing the adjustment, go to A23.000 and replace the 10 MHz standard assembly.

ILT.2710 If the 10 MHz standard is within tolerance but the CW accuracy is not, an undetected failure must also be present. Look for unlock indicators and investigate the sampler and fractional-N assemblies.

ILT.3000

Select the first faulty I/O port listed below.

Failing Input or Output	Go to Paragraph
Display Output	ILT.3010
Keyboard Input	ILT.3020
RF Output	ILT.2240
External ALC Input	ILT.3060
Rear Panel Source Module Interface	ILT.3070
Front Panel Source Module Interface	ILT.3080
HP-IB Input, Output	ILT.3090
10 MHz Ref Input	ILT.3100
10 MHz Ref Output	ILT.3110
Trigger Input	ILT.3120
Sweep Output	ILT.3200
V/GHz Output	ILT.3300
Stop Sweep Input, Output	ILT.3400
Z-Axis Blanking, Markers Output	ILT.3500
Trigger Output	ILT.3600
Auxiliary Interface	ILT.3700
Rear Panel HP-IB Address Switches	ILT.3800

ILT.3010 If the display is dim and flickering, check the dim display option: Press SYSTEM (MENU), and select Dim Display. Repeatedly select Dim Display to toggle this attribute.

Does the problem remain when you toggle
Dim Display?

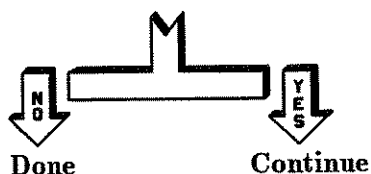

ILT.3011

The remaining display problems are most likely one of the following:

- Cosmetic fault. The display appearance is fuzzy, varies in brightness from segment to segment, or another superficial characteristic is questionable. Replace the display (go to A21.9000).
- The display takes a long time to update, and UNLOCK flashes in the display. Press **PRESET** **SERVICE** and select **Unlock Info**. The following is a prioritized list. Find the first one that applies.
 1. REF UNLOCK: go to A7.9000.
 2. SAMPLER UNLOCK: go to A6.9000.
 3. FRACN UNLOCK: go to A4.9000.
 4. YO UNLOCK: consider the following, in the order listed:
 - a. A6: go to A6.9000.
 - b. A5: go to A5.9000.
 - c. A13: go to A13.9000.
 - d. A26: go to RF.2690.
 5. HET UNLOCK: go to RF.2490.
- If the display updates slowly, examine (and modify, if required) calibration constant #554 using the following procedure:

Press **PRESET** **SERVICE**.
Select **Adjust Menu** **Calib Menu** **Select Cal**.
Press **554** **ENTER**.

Calibration constant #554 should be set to 245. If it is not, continue with the following:

Select **Modify Cal.**

Press **245** **ENTER**.

Select **Cal Util Menu** **Save Cal** **yes**.

- The display has an intermittent fault such as going blank, or unintelligible characters displayed. Possible failures include the following:
 1. Display (A21).
 2. Front panel processor (A3).
 3. Cables (W1, W3, W4).

If these alternatives do not fix the problem, use the instrument block diagram (located at the end of "Special Cases") to troubleshoot this problem.

ILT.3020 Keyboard problems are most likely one of the following:

- The display takes a long time to update, and UNLOCK flashes in the display. Press **PRESET** **SERVICE** and select **Unlock Info**. The following is a prioritized list. Find the first one that applies.
 1. REF UNLOCK: go to A7.9000.
 2. SAMPLER UNLOCK: go to A6.9000.
 3. FRACN UNLOCK: go to A4.9000.
 4. YO UNLOCK: consider the following, in the order listed:
 - a. A6: go to A6.9000.
 - b. A5: go to A5.9000.
 - c. A13: go to A13.9000.
 - d. A26: go to RF.2690.
 5. HET UNLOCK: go to RF.2490.
- Cosmetic fault. The appearance, or another superficial characteristic, is questionable. Replace the keyboard (go to A1.9000).
- The keyboard has an intermittent fault. Possible failures include the following:
 1. Keyboard (A1).
 2. Front panel processor (A3).
 3. Cables (W3, W5).
- If the display updates slowly, examine (and modify, if required) calibration constant #554 using the following procedure:

Press **PRESET** **SERVICE**.

Select **Adjust Menu** **Calib Menu** **Select Cal**.

Press **554** **ENTER**.

Calibration constant #554 should be set to 245. If it is not, continue with the following:

Select **Modify Cal**.

Press **245** **ENTER**.

Select **Cal Util Menu** **Save Cal** **yes**.

If these alternatives do not fix the problem, use the instrument block diagram (located at the end of "Special Cases") to troubleshoot this problem.

- ILT.3060** Check the continuity from the front panel external ALC input (rear panel for option 004) to the end of W9 (connects to A10J4).

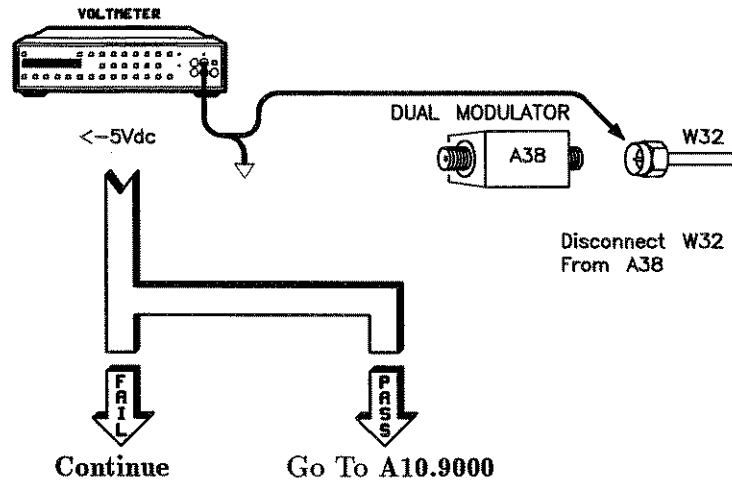

- ILT.3061** Replace the cable (W9) that connects the front panel external ALC input to A10J4, and go to the Troubleshooting Foldout, block 1 (located just prior to the “Special Cases” tab).
- ILT.3070** Using either an oscilloscope or a voltmeter, check the following voltages at the front panel SMI connector.

Location	Measurement
Pin 7	+5.2 Vdc
Pin 5	+15.0 Vdc
Pin 10,18,19,20	TTL High

Did all voltages pass?

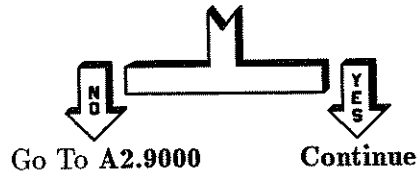

ILT.3071

Perform the following setup:

1. Press **PRESET**.
2. Press **SWEEP TIME** **10.0** **SEC**.

Using either an oscilloscope or a voltmeter, check the following voltages on the front panel SMI connector. Note that pin 12 is a sweep ramp. To adjust the sweep ramp, change the instrument sweep time (if you use an oscilloscope, try a sweep time of approximately 100 ms).

Location	Measurement
Pin 15	-15 Vdc
Pin 6	+8.0 Vdc
Pin 12	Sweep Ramp (0 to 10.0V)

Did all voltages pass?

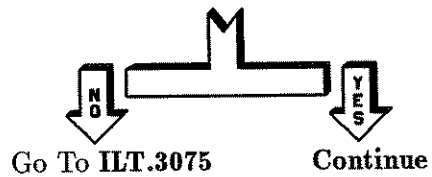

ILT.3072 Measure on the center pin at each end of the cable.

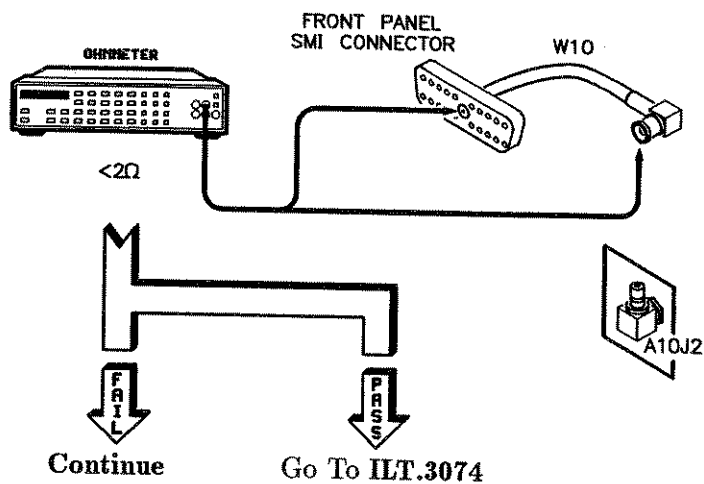

ILT.3073 Replace the cable (W10) that connects the front panel SMI input to the A10 assembly, and go to the Troubleshooting Foldout, block 1 (located just prior to the "Special Cases" tab).

ILT.3074 Although the problem has not been isolated, the following are possible:

- The front panel SMI (A2) is faulty.
- W2 is faulty (connects A2 to the motherboard).
- The ALC assembly (A10) is faulty. This is true if leveling is the problem.
- The source module used with the synthesizer is faulty. To confirm this, either use the rear panel SMI, or substitute a new source module or synthesizer.
- A remote possibility exists that the motherboard (A22) is faulty.

If these alternatives do not fix the problem, use the instrument block diagram (located at the end of "Special Cases") to troubleshoot this problem.

ILT.3075 Either the front panel SMI (A2) or the ribbon cable (W10) is faulty. Inspect the ribbon cable. Replace the A2 assembly or W10, as required, and go to the Troubleshooting Foldout, block 1 (located just prior to the “Special Cases” tab).

ILT.3080 Using either an oscilloscope or a voltmeter, check the following voltages at the rear panel SMI connector.

Location	Measurement
Pin 7	+5.2 Vdc
Pin 5	+15.0 Vdc
Pin 10, 18, 19, 20	TTL High

Did all voltages pass?



Go To A19.9000

Continue

ILT.3081 Perform the following setup:

1. Press **PRESET**.
2. Press **SWEEP TIME** **10** **SEC**.

Using an oscilloscope or a voltmeter, check the following voltages on the rear panel SMI connector. Note that pin 12 is a sweep ramp. To change the sweep ramp, change the sweep time (using an oscilloscope, try a sweep time of approximately 100 ms).

Location	Measurement
Pin 15	-15 Vdc
Pin 6	+8.0 Vdc
Pin 12	Sweep Ramp (0 to 10V)

Did all voltages pass?



Go To ILT.3085

Continue

ILT.3082 Measure at the center pin at each end of the cable.

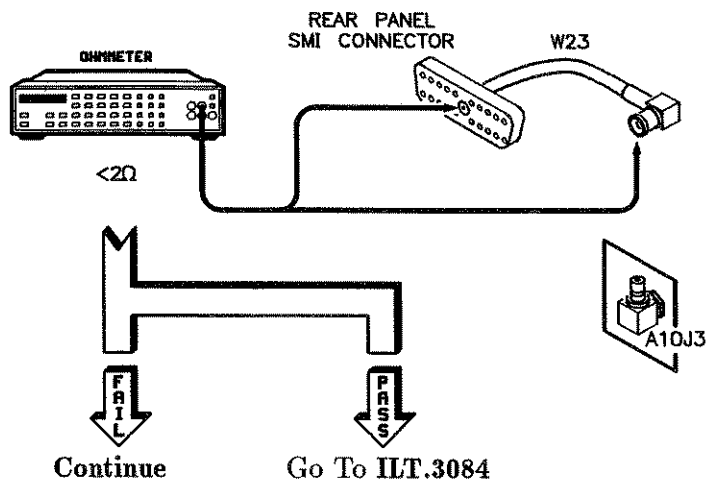

ILT.3083 Replace the cable (W23) that connects the rear panel SMI input to the A10 assembly, and go to the Troubleshooting Foldout, block 1 (located just prior to the “Special Cases” tab).

ILT.3084 The problem is not isolated, but the following are possible failures:

- The rear panel SMI (A19) is faulty.
- W31 is faulty (connects A19 to the motherboard).
- The ALC assembly (A10) is faulty. This is true if leveling is the problem.
- The source module used with the synthesizer is faulty. To confirm this, try to use the front panel SMI, or substitute either a new source module or synthesizer.
- A remote possibility exists that the motherboard (A22) is faulty.

If these alternatives do not fix the problem, use the instrument block diagram (located at the end of “Special Cases”) to troubleshoot this problem.

ILT.3085 Either the rear panel SMI (A19) or the ribbon cable (W23) is faulty. Inspect the ribbon cable. Replace the A19 assembly or W23, and go to the Troubleshooting Foldout, block 1 (located just prior to the “Special Cases” tab).

ILT.3090 HP-IB problems involve a ribbon cable and one of three assemblies. The assemblies are listed below from most to least likely to fail. First, run the HP-IB port self-test that follows. If this self-test fails, the CPU assembly (A15) is the most likely failure. If this test passes, change the assemblies in the order listed.

1. Ensure that nothing is connected to the HP-IB connector.
2. Press **PRESET** **SERVICE**.

3. Select **SelfTest Menu**.
4. Press **236** **ENTER**.
5. Select **Do Test #236**.

Most likely failures:

1. An excessive length of HP-IB cable. (The specification for length of HP-IB cable is no more than 2 meters per instrument and a maximum of 20 meters. Exceeding this length may lock up the data bus.)
2. The rear panel SMI (A19).
3. The CPU assembly (A15).
4. The ribbon cable W23 (connects A19 to motherboard).
5. There is a remote possibility of a motherboard (A22) fault.

If these alternatives do not fix the problem, consult "Special Cases" to troubleshoot this problem.

ILT.3100 Check the continuity from the rear panel 10 MHz input to the end of W16 (connects to A7J1).

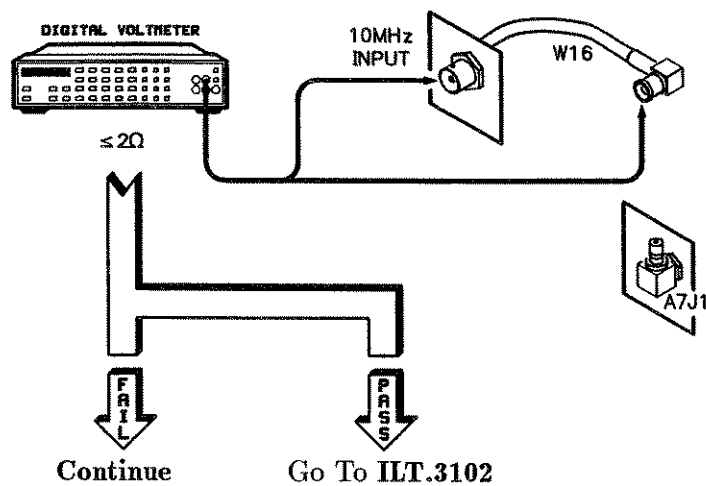

ILT.3101 Replace W16 and go to the Troubleshooting Foldout, block 1 (located just prior to the "Special Cases" tab).

ILT.3102

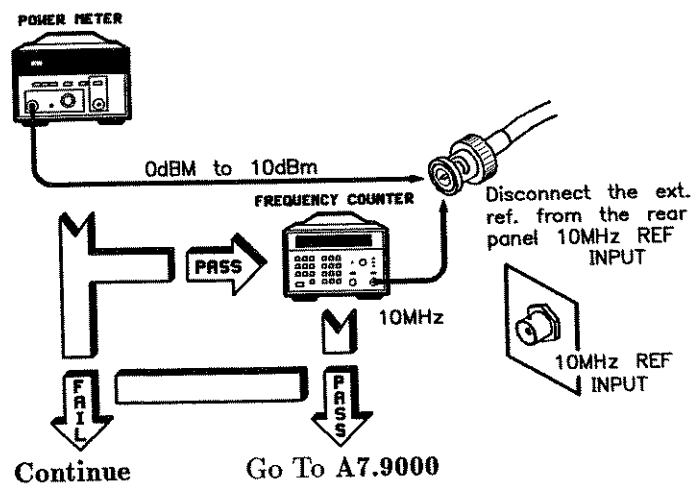

ILT.3103 Correct the reference into the rear panel. If a problem still exists, refer to the instrument block diagram (located at the end of "Special Cases") to troubleshoot this problem.

ILT.3110

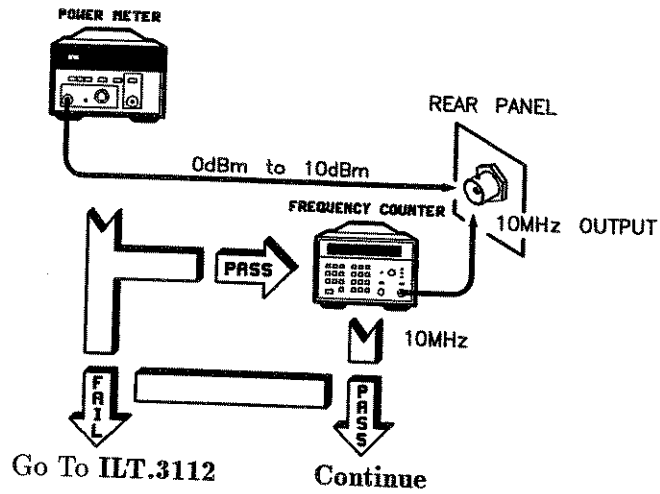

ILT.3111 There does not seem to be a failure. The rear panel output should be 10 MHz at approximately 0 dBm. If a problem still exists, refer to the instrument block diagram (located at the end of "Special Cases") to troubleshoot this problem.

ILT.3112

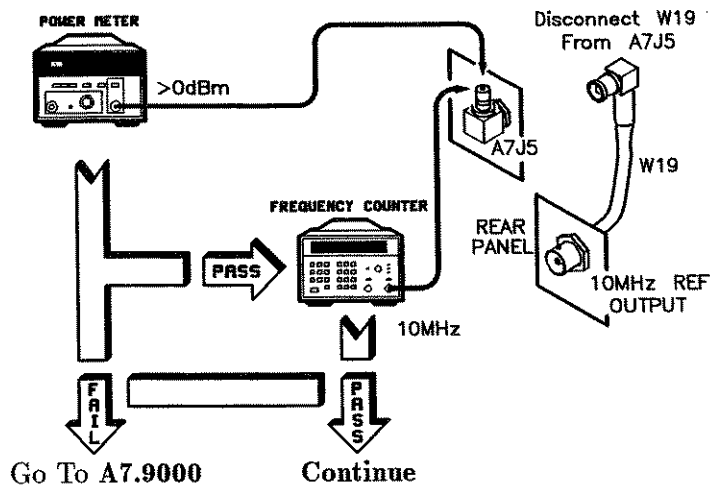

ILT.3113 Replace W19, the coaxial cable that connects A7J5 to the rear panel, and go to the Troubleshooting Foldout, block 1 (located just prior to the "Special Cases" tab).

ILT.3120 Before continuing, be sure that auto sweep operates correctly. If it does not, restart troubleshooting at ILT.000.

Measure the resistance between the TRIGGER INPUT and XA15J1-61.

Is the resistance ≥ 90 and $\leq 110\Omega$?

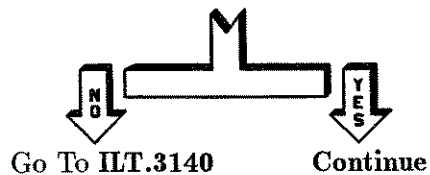

ILT.3121 Perform the following setup:

1. Press **PRESET SWEEP MENU**.
2. Select **Start Sweep Trigger Ext.**
3. Press **SWEEP TIME 5 SEC**.

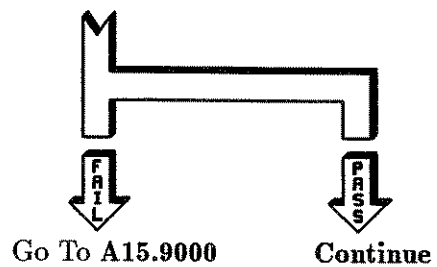
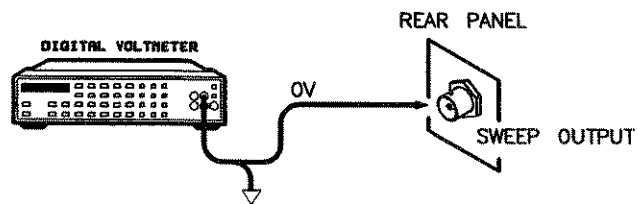

ILT.3122 Is the front panel SWEEP indicator flashing and do you have a front panel?

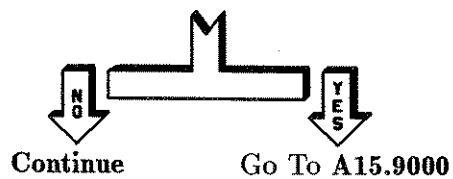

ILT.3123 Perform the following setup:

- Connect a function generator to the rear panel trigger input.
- Set the function generator for a 10 Hz, TTL square wave.
- Observe the SWEEP OUTPUT on the rear panel.

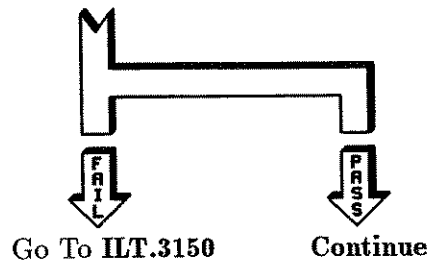
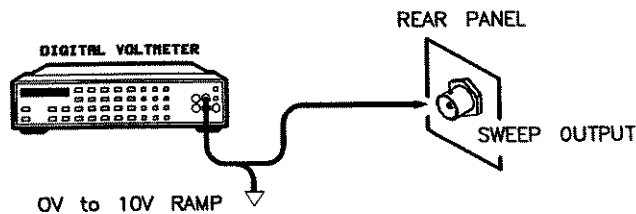

ILT.3124 Does your instrument have a front panel with a display and is the front panel SWEEP indicator flashing?

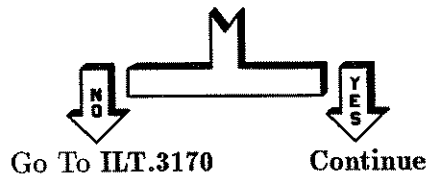

ILT.3125 The trigger and sweep output seem to be working. If an undetected failure exists, look at the instrument block diagram (located at the end of "Special Cases"). The assemblies most intimately tied to the trigger input and sweep output are the sweep generator assembly (A14) and the CPU assembly (A15).

ILT.3140 Measure the resistance between A22J8-41 and XA15J1-61.

Is the resistance $> 2\Omega$?

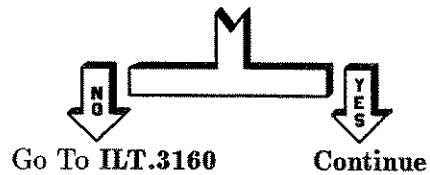

ILT.3141 There is an open on the motherboard between A22J8-41 and XA15J1-61. Verify this with an ohmmeter. Is jumpering an acceptable repair?

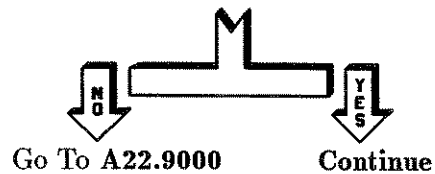

ILT.3142 Install a jumper and go to the Troubleshooting Foldout, block 1 (located just prior to the "Special Cases" tab).

ILT.3150 Measure the resistance between SWEEP OUTPUT and XA14J2-4.

Is the resistance 90 to 110Ω ?



- ILT.3151** Measure the resistance between A22J8-31 and XA14J2-4.
Is the resistance $> 2\Omega$?

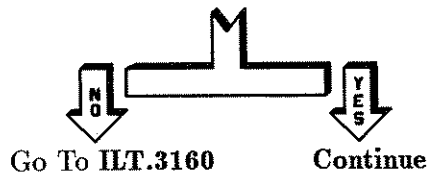

- ILT.3152** There is an open on the motherboard between A22J8-31 and XA14J2-4. Verify this with an ohmmeter. Is jumpering an acceptable repair?

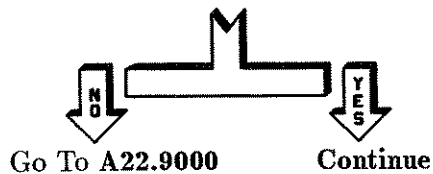

- ILT.3153** Install a jumper and go to the Troubleshooting Foldout, block 1 (located just prior to the "Special Cases" tab).

- ILT.3160** A fault exists in either the rear panel SMI (A19) or the ribbon cable W31. Inspect W31. Replace the rear panel SMI (A19) or W31, and go to the Troubleshooting Foldout, block 1 (located just prior to the "Special Cases" tab).

ILT.3170 Perform the following setup:

1. Press **PRESET** **START** **5** **GHz**.
2. Press **STOP** **7** **GHz**.
3. Press **SWEEP TIME** **5** **SEC**.
4. Press **SINGLE**.
5. To make the measurement repeatedly, press **SINGLE**.
A TTL should be present that goes low for about 5 seconds, then high, each time you press **SINGLE**.

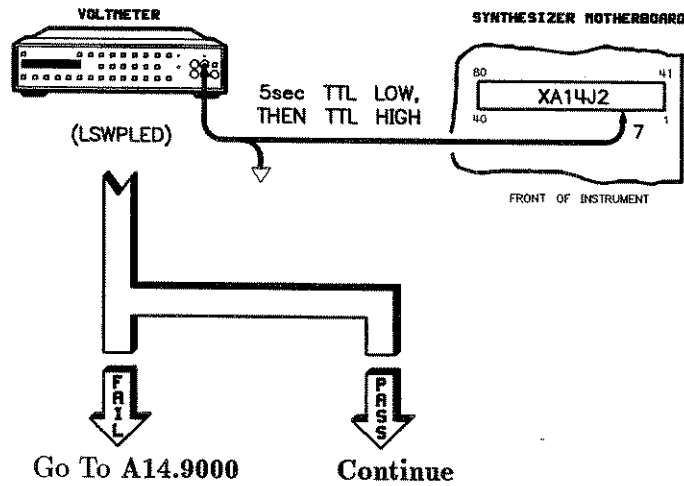

ILT.3171 Repeatedly press **SINGLE**. You should see a 5 second TTL low.

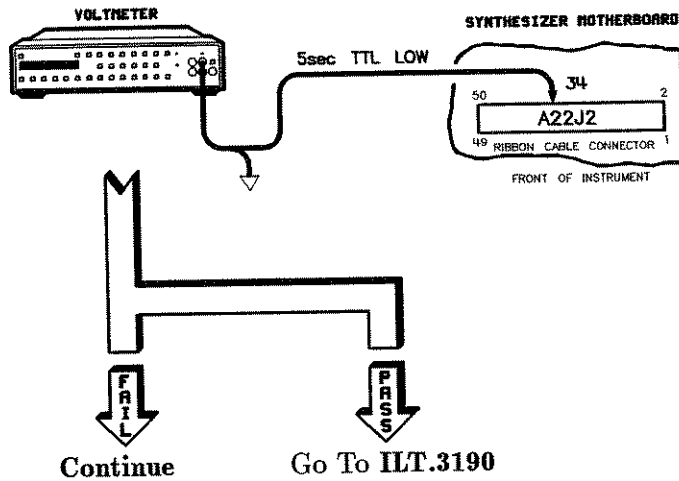

ILT.3180 There is an open on the motherboard between XA14J2-7 and A22J2-34. Verify this with an ohmmeter. Is jumpering an acceptable repair?

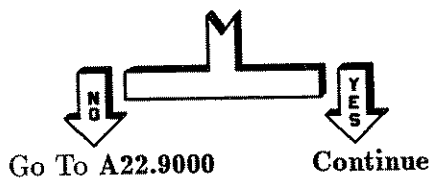

ILT.3181 Install a jumper and go to the Troubleshooting Foldout, block 1 (located just prior to the "Special Cases" tab).

ILT.3190 There is a fault associated with the front panel processor assembly (A3), keyboard (A1), or the interconnecting cables W3 (motherboard to A3) or W5 (A3 to A1). Either check the ribbon cables, replace the appropriate assemblies, or both. If these alternatives do not fix the problem, use the instrument block diagram (located at the end of "Special Cases") to troubleshoot this problem.

ILT.3200 Perform the following setup:

1. Press **PRESET** **START** **5** **GHz**.
2. Press **STOP** **7** **GHz**.
3. Press **SWEEP TIME** **100** **msec**.

You should see a 100 msec, 0.0 to 10.0V ramp.

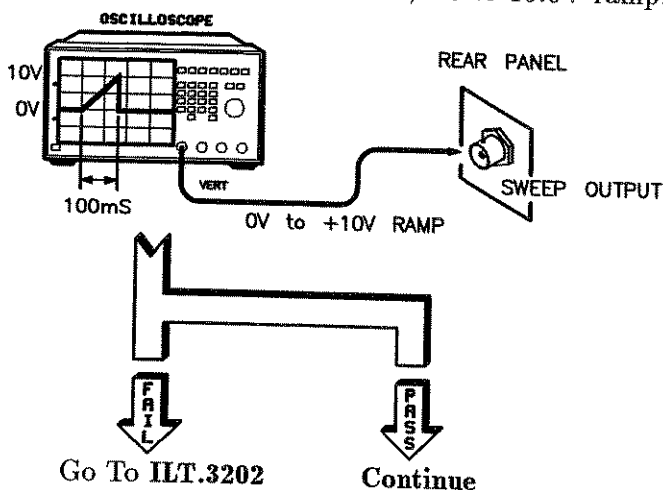

ILT.3201 Nothing seems to fail. If an intermittent or non-linear sweep output failure exists, the most likely failure is the sweep generator assembly (A14). Less likely failures are the rear panel SMI (A19), and the ribbon cable (W31). If these alternatives do not fix the problem, use the instrument block diagram (located at the end of "Special Cases") to troubleshoot this problem.

ILT.3202

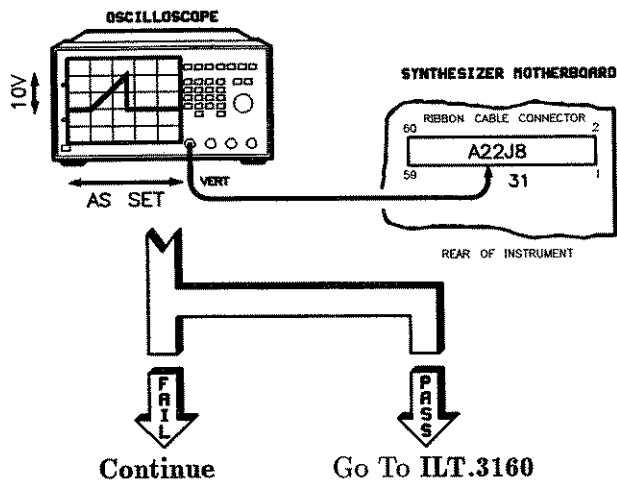

ILT.3203

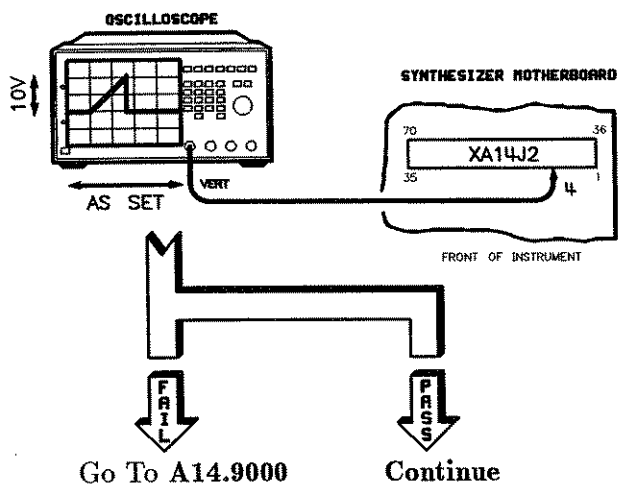

ILT.3204 There is an open on the motherboard between XA14J2-4 and A22J8-31. Verify this with an ohmmeter. Is jumpering an acceptable repair?

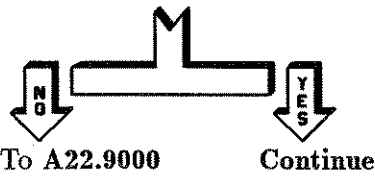

ILT.3205 Install a jumper and go to the Troubleshooting Foldout, block 1 (located just prior to the “Special Cases” tab).

ILT.3300 Turn the power switch to standby and remove the multiplier/filter driver assembly (A12). Inspect the DIP switch on the A12 assembly. The switch should be set as indicated in the table below.

Upper Freq Limit	Switch 1	Switch 2	Switch 3	Switch 4	Switch 5
≤ 15.0 GHz	Closed	Closed	Closed	Closed	Open
15.0 to 30.0 GHz	Open	Open	Closed	Closed	Open
≥ 30.0 GHz	Open	Open	Open	Open	Open

Are any of the switches set incorrectly?

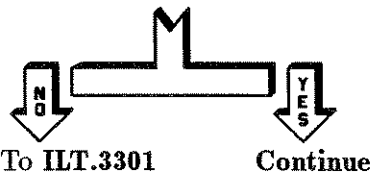

Correct the switch settings, reinstall A12, and go to the Troubleshooting Foldout, block 1 (located just prior to the “Special Cases” tab).

ILT.3301 Perform the following setup:

1. Press **PRESET** **SWEEP TIME**.
2. Press **5** **SEC**.
3. Observe the Volts/GHz out the rear panel.
4. The scaling of the ramp can be 1, 0.5, or 0.25 V/GHz.
See the following table.

Upper Frequency Limit (GHz)	Scaling Volts/GHz
≤ 15	1.0
15 to 30	0.5
≥ 30	0.25

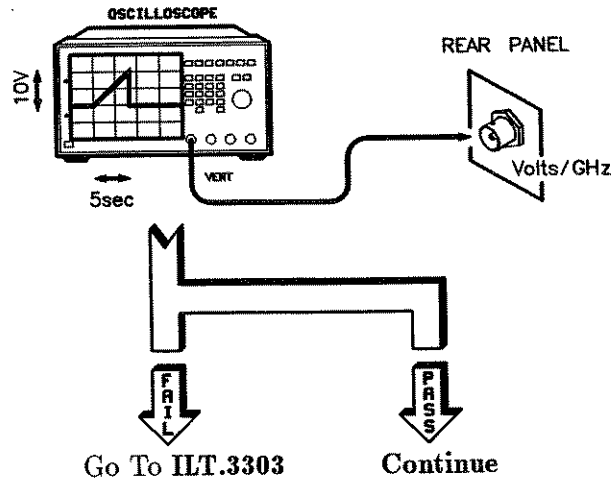

- ILT.3302** Nothing seems to be wrong with the Volts/GHz output. If there is an undetected fault, the most likely source is the multiplier/filter driver assembly (A12). If the problem still exists, go to "Special Cases" to troubleshoot this problem.

ILT.3303

Upper Frequency Limit (GHz)	Scaling Volts/GHz
≤ 15	1.0
15 to 30	0.5
≥ 30	0.25

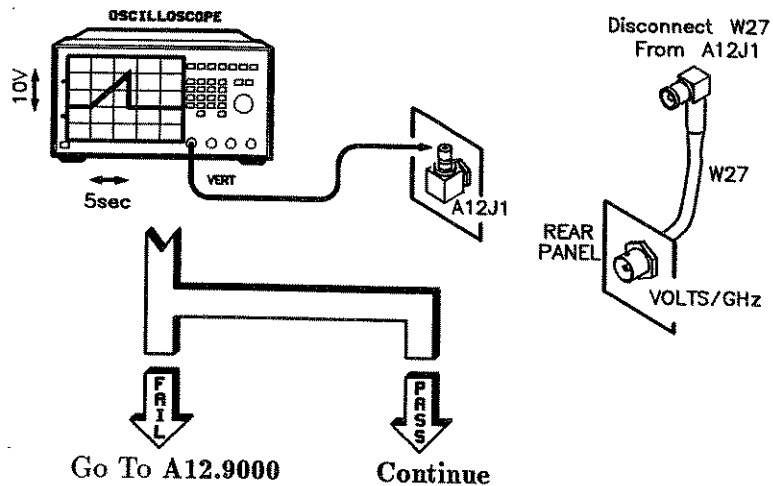

Replace W27 (connects A12 to the rear panel Volts/GHz), and go to the Troubleshooting Foldout, block 1 (located just prior to the "Special Cases" tab).

ILT.3400 Perform the following setup:

1. Press **PRESET** **SWEEP TIME**.
2. Press **30** **SEC**.

Alternately short to ground and open the rear panel STOP SWEEP IN/OUT center conductor. Observe the SWEEP OUTPUT at the rear panel with a voltmeter; if the instrument has a front panel with a display and keyboard, observe the SWEEP indicator on the front panel. When the center conductor is shorted to ground,

the SWEEP OUTPUT should stop sweeping and the front panel SWEEP indicator should be off; when the center conductor is not shorted to ground, the output should sweep, and the indicator should be on (or blinking).

Does the STOP SWEEP IN/OUT properly control the rear panel SWEEP OUTPUT and the front panel SWEEP indicator?

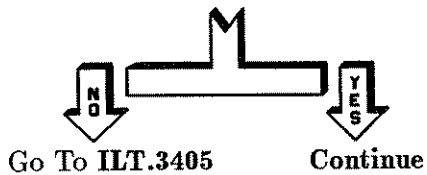

ILT.3401 Press **SWEEP TIME** **2** **SEC**. You should see a TTL high with a short TTL low every 2 to 3 seconds.

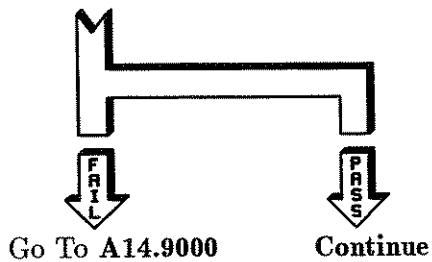
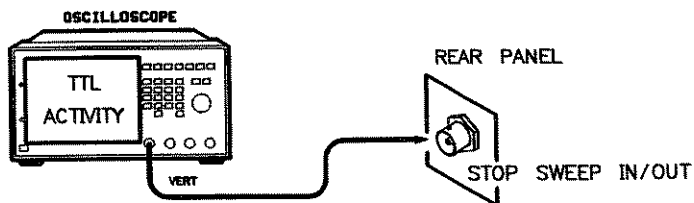

ILT.3402 The rear panel STOP SWEEP IN/OUT seems to be working properly. If an undetected problem exists, consider replacing the sweep generator assembly (A14.9000). Otherwise, use the instrument block diagram (located at the end of "Special Cases") to troubleshoot this problem.

ILT.3405 Identify XA14J2-36. Alternately short to ground and open the XA14J2-36. Observe the SWEEP OUTPUT at the rear panel with a voltmeter; if the instrument has a front panel with a display and keyboard, observe the SWEEP indicator on the front panel. When the pin is shorted to ground, the SWEEP OUTPUT should stop sweeping and the front panel SWEEP indicator should be off; when the pin is not shorted to ground, the output should sweep, and the indicator should be on (or blinking).

Does XA14J2-36 properly control the front panel SWEEP indicator?



Go To A14.9000

Continue

ILT.3406 Identify A22J8-35. Alternately short to ground and open A22J8-35. Observe the SWEEP OUTPUT at the rear panel with a voltmeter; if the instrument has a front panel with a display and keyboard, observe the SWEEP indicator on the front panel. When the pin is shorted to ground, the SWEEP OUTPUT should stop sweeping and the front panel SWEEP indicator should be off; when the pin is not shorted to ground, the output should sweep, and the indicator should be on (or blinking).

Does A22J8-35 properly control the front panel SWEEP indicator?

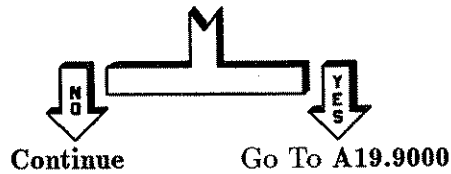

ILT.3407

There is an open on the motherboard between XA14J2-36 and A22J8-35. Verify this with an ohmmeter. Is jumpering an acceptable repair?

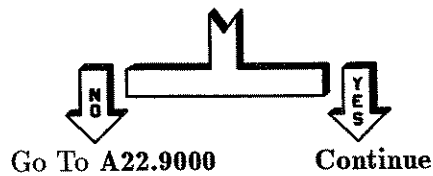

Install a jumper and go to the Troubleshooting Foldout, block 1 (located just prior to the "Special Cases" tab).

ILT.3500 Perform the following setup:

1. Press **PRESET**.
2. Press **SWEEP TIME** **5** **SEC** **SINGLE**.
3. Press **START** **5** **GHz**.
4. Press **STOP** **7** **GHz**.
5. Checking the Z-AXIS BLANK/MKRS on the rear panel, repeatedly press **SINGLE**.
 - a. While not sweeping = TTL high.
 - b. During sweep = TTL low.

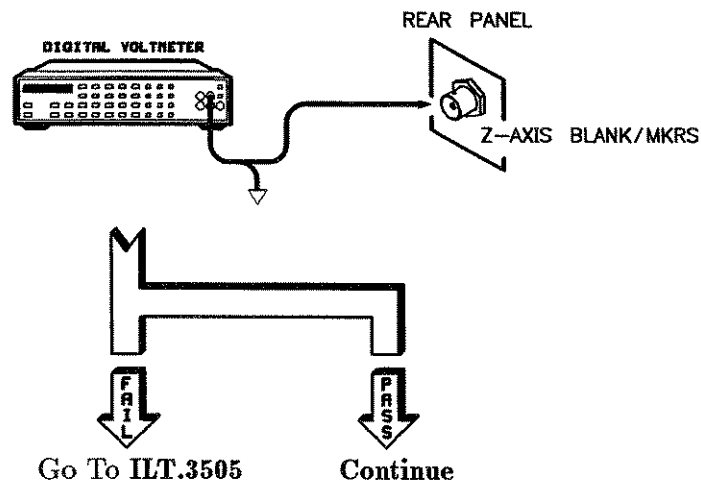

ILT.3501 The rear panel Z-AXIS BLANK/MKRS seems to be working properly. If an undetected problem exists, consider replacing the sweep generator assembly (A14.9000).

ILT.3505 Checking XA14J1-78, repeatedly press **SINGLE**.

- Not sweeping = TTL high.
- During sweep = TTL low.

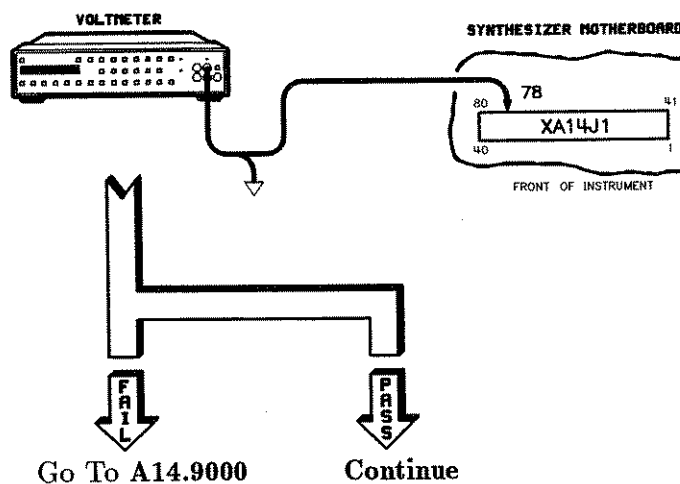

ILT.3506 Checking A22J8-37, repeatedly press **SINGLE**.

- Not sweeping = TTL high.
- During sweep = TTL low.

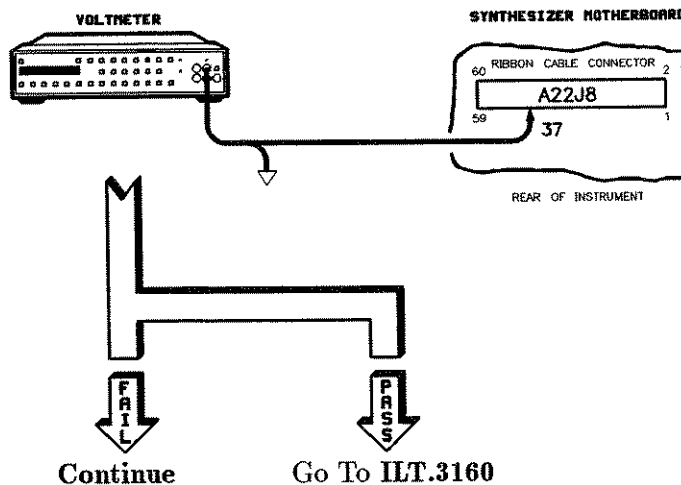

ILT.3507 There is an open on the motherboard between XA14J1-78 and A22J8-37. Verify this with an ohmmeter. Is jumpering an acceptable repair?

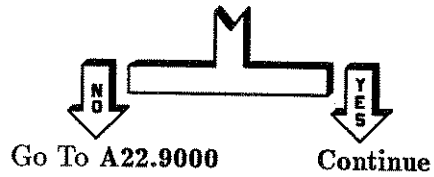

ILT.3508 Install a jumper and go to the Troubleshooting Foldout, block 1 (located just prior to the "Special Cases" tab).

ILT.3600 Press **PRESET**. Check for a negative going TTL pulse at the TRIGGER OUTPUT connector on the rear panel.

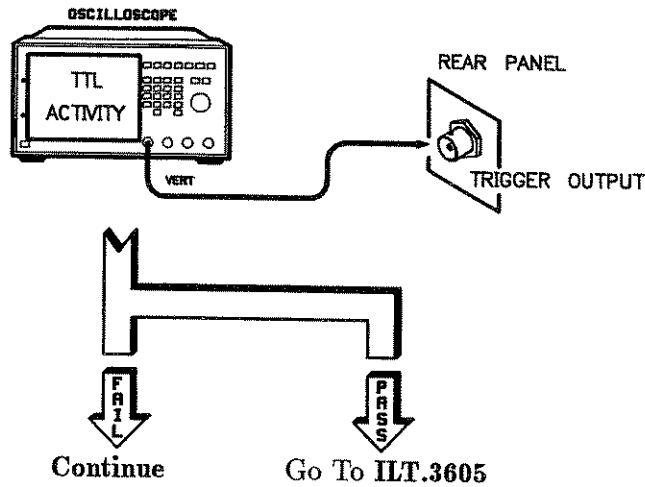

ILT.3601 Press **PRESET**. Check for a negative going TTL pulse at A14J2.

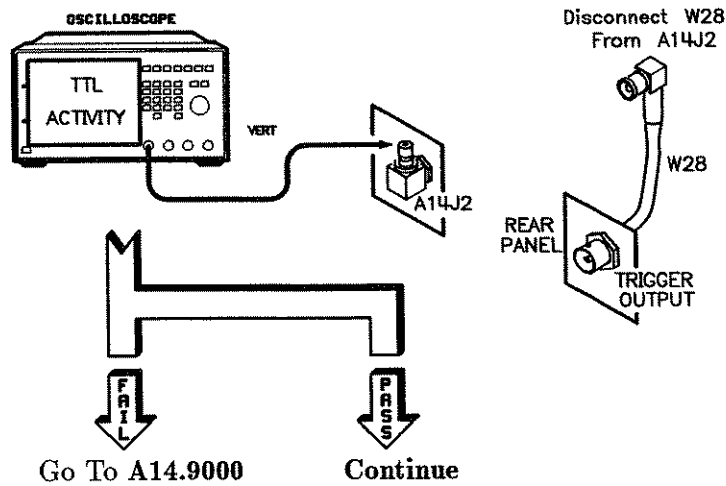

Replace W28 and go to the Troubleshooting Foldout, block 1 (located just prior to the "Special Cases" tab).

ILT.3605 The rear panel TRIGGER OUTPUT seems to be working properly. If an undetected problem exists, consider replacing the sweep generator assembly (A14.9000).

ILT.3700 Press **PRESET**. Using an oscilloscope, check for TTL levels at the following points on the rear panel AUXILIARY INTERFACE connector. If a failure occurs (there is no TTL activity on one or more of the lines), go to the indicated paragraph.

Note: Some of these signals move very slowly.

Pin Number	Go to Paragraph
2	ILT.3710
5	ILT.3720
12	ILT.3730
15	ILT.3740
24	A19.9000

If no failure occurs, continue with ILT.3701.

ILT.3701 Perform the following setup:

1. Press **START SWEEP** **3** **GHz**.
2. Press **STOP SWEEP** **7** **GHz**.

Check for a 0 to 10V ramp at pin 18 of the AUXILIARY connector.

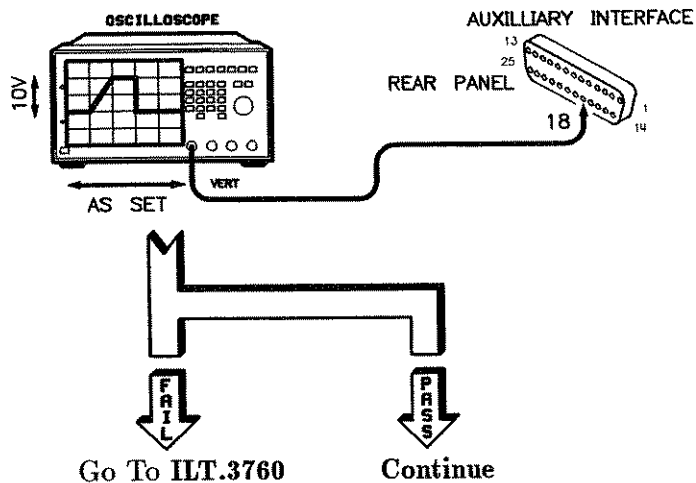

ILT.3702

Locate pin 5 on the auxiliary interface. Alternately short to ground and open pin 5. Observe pin 18 with a voltmeter; if the instrument has a front panel with a display and keyboard, observe the SWEEP indicator on the front panel. When pin 5 is shorted to ground, the output at pin 18 should stop sweeping and the front panel SWEEP indicator should be off; when the pin is not shorted to ground, the output at pin 18 should sweep, and the indicator should be on (or blinking). This is the stop sweep line that connects to the rear panel BNC of the same name.

Did the sweep stop and start as described?

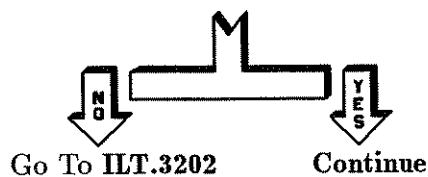

ILT.3703 Locate pin 15 on the auxiliary interface. Alternately short to ground and open pin 15. Observe pin 18 with a voltmeter; if the instrument has a front panel with a display and keyboard, observe the SWEEP indicator on the front panel. When the pin is shorted to ground, the output at pin 18 should stop sweeping and the front panel SWEEP indicator should be off; when the pin is not shorted to ground, the output at pin 18 should sweep, and the indicator should be on (or blinking). This is the LQSS signal, used to synchronize the A4 assemblies in systems that have more than one HP 8360 series synthesized sweeper.

Did the sweep stop and start as described?



ILT.3704 Most (but not all) auxiliary inputs and outputs have been checked. The remaining faults will appear to be synchronization problems related to having multiple HP 8360 series sweepers in a system, or problems with markers.

Are you sure the instrument has an auxiliary interface problem?



ILT.3710 Press **PRESET** and check for TTL activity.

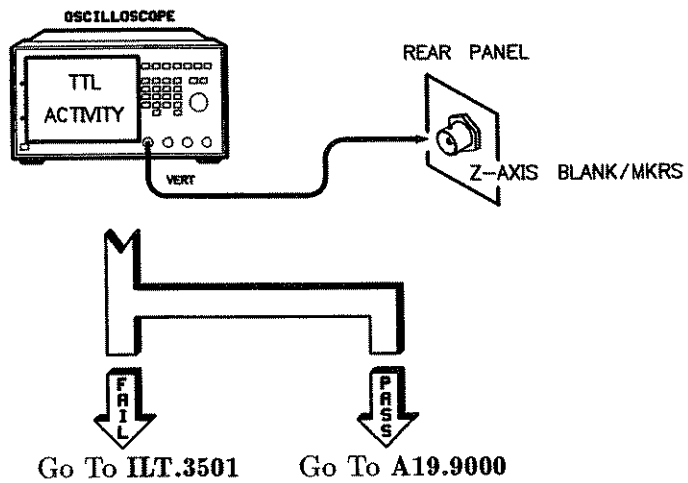

ILT.3720 Press **PRESET** and check for TTL activity.

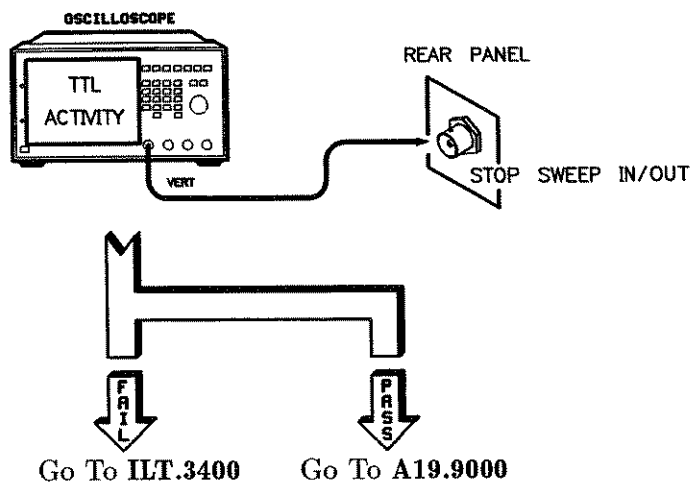

ILT.3730 Check for TTL activity at J8-36 on the motherboard.

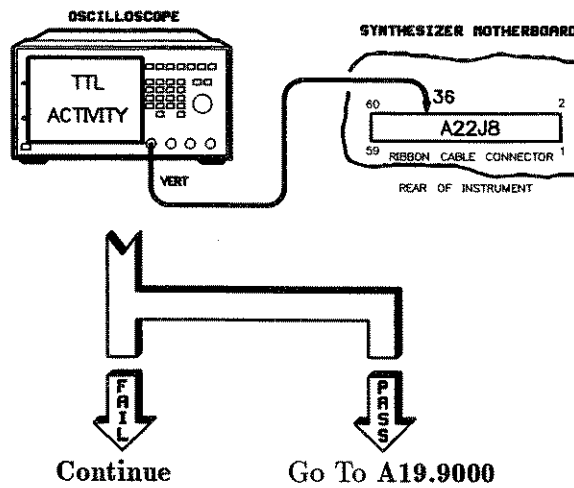

ILT.3731 Check for TTL activity at XA14P2-37 on the motherboard.

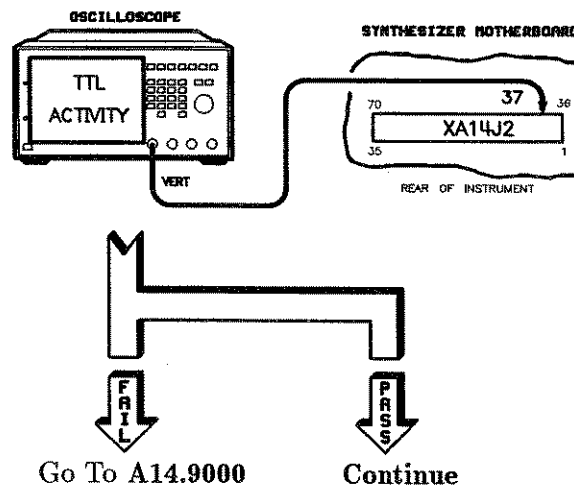

ILT.3735 There is an open on the motherboard between A22J8 and XA14J2-37. Verify this with an ohmmeter. Is jumpering an acceptable repair?

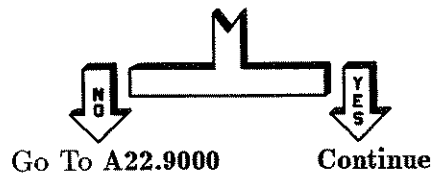

ILT.3736 Repair the open between J8-36 and XA14P2-37, and go to the Troubleshooting Foldout, block 1 (located just prior to the "Special Cases" tab).

ILT.3740 Check for TTL activity at J8-39 on the motherboard.

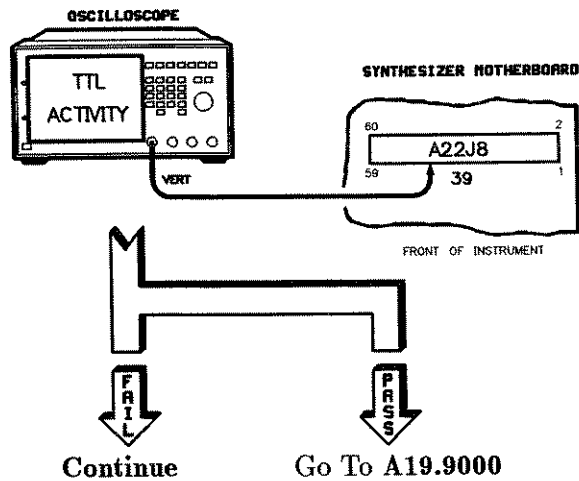

ILT.3741 Check for TTL activity at XA14P1-68 on the motherboard.

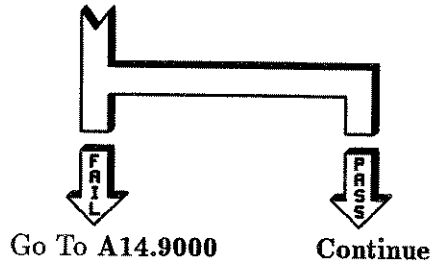
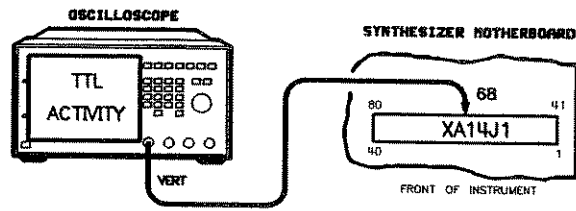

ILT.3745 There is an open on the motherboard. Is jumpering an acceptable repair?

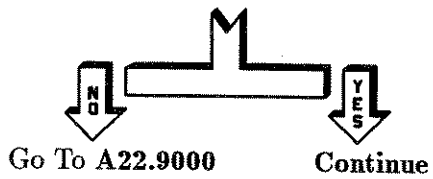

ILT.3746 Repair the open between J8-39 and XA14P1-68, and go to the Troubleshooting Foldout, block 1 (located just prior to the "Special Cases" tab).

ILT.3800

The rear panel HP-IB switch controls the instrument language and address. Check the following list for possible solutions to the problem:

- To control the language from the front panel, the language portion of the HP-IB switch must be set to 7 (binary 111).
- For instruments using SCPI, set the language part of the switch to 0 (binary 000).
- For instruments using Analyzer language, set the switch to 1 (binary 001). If the instrument is used with HP 8510 systems, either set the language part of the switch to 1 or set the language to Analyzer language at the front panel. This also applies to systems that depend on HP 8340/8341 compatibility.
- For instruments using CIIL, either set the switch to 2 (binary 010), or set it to 7 (binary 111) and set the language to CIIL at the front panel. This language is an option.
- For MSIB instruments (including option H10), set the switch to 3 (binary 011). This cannot be set from the front panel.
- Concerning the address switches, the HP 8510 (and other systems) assume that the HP-IB address is 19 (binary 10011).

Did any of these suggestions fix the problem?

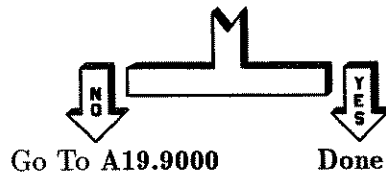

ILT.4000

Each function has a most likely assembly or group of assemblies responsible for an undefined fault. Most of these faults are microprocessor control type faults, and often point to the CPU assembly (A15). The circuitry has been previously exercised by the self-tests. The functions listed below are primarily microprocessor manipulations of the previously tested hardware. Also use the block diagram (located at the end of "Special Cases") for further assistance.

- Power level functions:
 - RF on/off does not function properly: go to ILT.3052.
 - Power sweep does not function: go to A15.9000, possibly A14.9000.
 - Unable to set power slope: go to A15.9000.
 - Unable to uncouple the attenuator: go to A15.9000 or A20.9000.
 - Unable to set up/down power size: go to A15.9000.
- Setting frequencies (start, stop, CW, etc.):
 - Unable to set up/down size: go to A15.9000.
 - Unable to set frequency offset: go to A15.9000.
 - Unable to set frequency multiplier: go to A15.9000.
- Unable to control marker functions: go to A15.9000, possibly A14.9000.
- Sweep function control:
 - List function does not work properly: go to A15.9000.
 - Unable to control one of the following:
 - Step size: go to A15.9000.
 - Step points: go to A15.9000.
 - Step dwell: go to A15.9000.
 - Step sweep trigger: go to A15.9000.
 - Sweep ramp functions improperly: go to A14.9000.
- Frequency list does not work properly:
 - For frequency changes greater than 500 MHz, if unleveled or unlock indicators appear, try the amp/multiplier adjustments.

- For all other cases, A15 is the most likely cause of failure. Go to A15.9000 to replace A15.
- Fast sweep time problems (≤ 100 ms sweep time): Do the YO or amp/multiplier adjustments (see the *Service manual*).
- Slow sweep time problems (≥ 5 s sweep time): Do the YO or amp/multiplier adjustments (see the *Service manual*).
- Unable to properly control single sweep or manual sweep:
 - Single sweep: If you cannot control single sweep, go to A15.9000. If you *can* control single sweep but the RF signal deteriorates badly, you may need to adjust the amp/multiplier, amp/filter, or YO. Go to the *Service manual*.
 - Manual Sweep: go to A15.9000. If the rotary knob is not functioning, replace only the RPG (rotary pulse generator).
- Unable to use trigger sweep: go to A15.9000.
- Trigger out delay does not work: First replace the A15 assembly (go to A15.9000). If the problem remains, replace the A14 assembly (go to A14.9000).
- Save/recall registers do not function properly:
 - If you are unable to save or recall registers: go to A15.9000.
 - If the save/recall registers are lost when power is turned off, then replace the battery on A15 (A15BT1). If the battery has already been replaced, go to A15.9000.

If these alternatives do not fix the problem, use the instrument block diagram (located at the end of “Special Cases”) to troubleshoot this problem.

ILT.5000

To continue, you will need either the front panel emulation software for the HP 8360 series synthesizers, or a substitute front panel. Refer to “Automated Tests” in the *Service* manual for the software and instructions. Refer to “Replaceable Parts” in the *Service* manual for substitute front panel ordering information. Start the front panel emulation software, or install a substitute front panel.

If the front panel emulation software or substitute front panel is operational, go to ILT.103. If not, use the following information to determine the next step:

- If you used a substitute front panel but it didn’t work, restart troubleshooting with that substitute front panel installed (go to ILT.000).
- If you used the front panel emulator program (part of the “Service Support Software”) but it didn’t work, go to ILT.6810.

ILT.6000

Replace RPG1 and go to the Troubleshooting Foldout, block 1 (located just prior to the “Special Cases” tab).

ILT.6500

Does your instrument have a front panel display and keyboard?

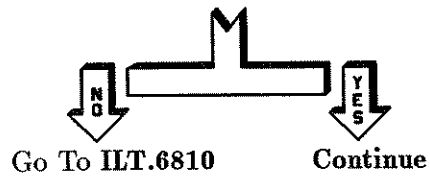

ILT.6501

Does the instrument display
*** POWER SUPPLY FAILURE *** ?

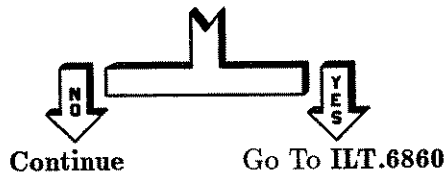

ILT.6502

Does the instrument display
*** CHECK INSTRUMENT *** ?

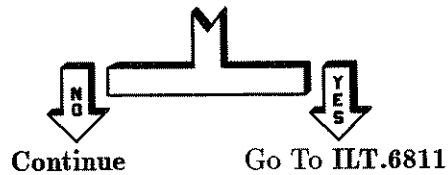

ILT.6504

Is the display blank, nearly blank, or unintelligible?

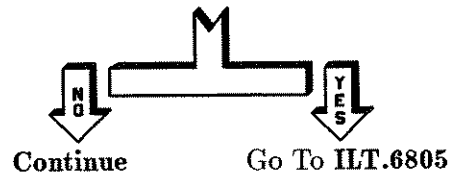

ILT.6505 Is the keyboard unresponsive?

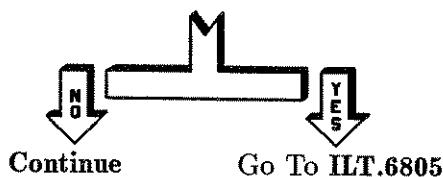

ILT.6506 Is the front panel red INSTR CHECK light *on*?

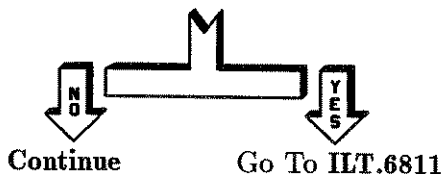

ILT.6507 Does the display appear correct except for missing segments?

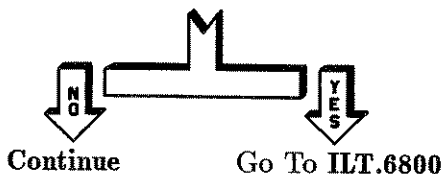

ILT.6508 Since these tests could not isolate the problem, go to "Special Cases" and continue troubleshooting.

ILT.6800 The most likely cause for this failure is the display (A21.9000), but the front panel microprocessor assembly (A3.9000) could also be at fault.

If these alternatives do not fix the problem, use the instrument block diagram (located at the end of "Special Cases") to troubleshoot this problem.

ILT.6805 Perform the following:

1. Set the line power switch to STANDBY.
2. Remove the front panel (refer to the disassembly procedures as needed).
3. Reseat all ribbon cables on the front panel.
4. Reseat all ribbon cables connecting the front panel to the motherboard.
5. Replace the front panel on the instrument.
6. Set the line power switch to ON.

Is the keyboard or display problem still present?

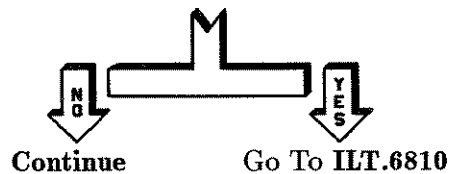

ILT.6806 The problem has apparently been solved by reseating the cables and reassembling the front panel. Restart troubleshooting at ILT.000.

ILT.6810 Do the following:

1. Turn the line power switch to ON.
2. Check the indicators on the top edge of A16 for the following:
 - a. Check that all eight green indicators are on.
 - b. Check that all red indicators are off.

Are all A16 indicators correct?

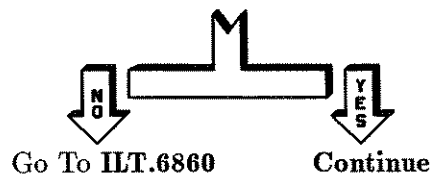

ILT.6860

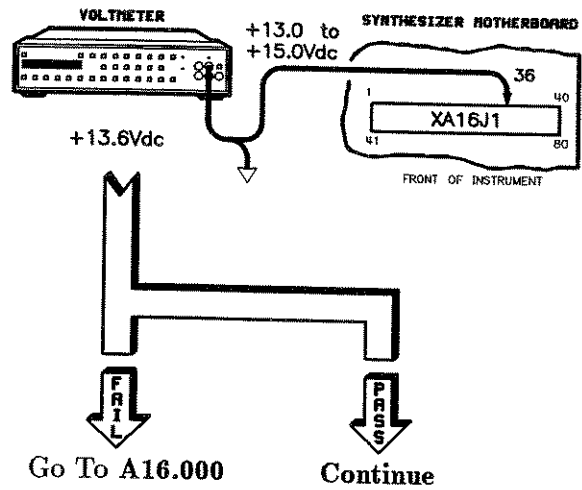

ILT.6861

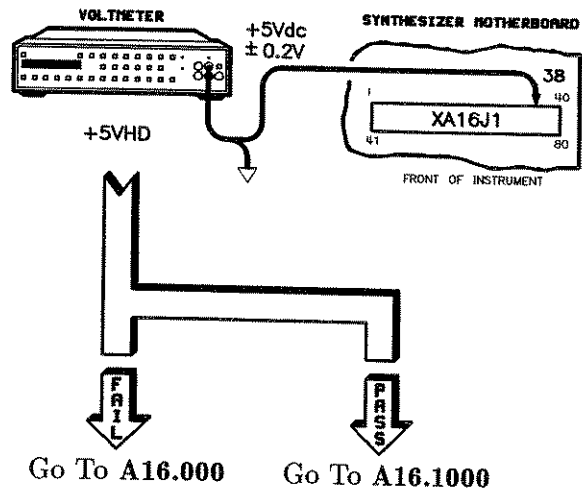

ILT.6900

The most likely cause for this failure is the keyboard assembly (A1.9000), but the front panel microprocessor assembly (A3.9000) could also be at fault.

If these alternatives do not fix the problem, use the instrument block diagram (located at the end of "Special Cases") to troubleshoot this problem.

ILT.7000

Recall the calibration constants from EEPROM.

1. Press **PRESET** **SERVICE**.
2. Select **Adjust Menu** **Calib Menu** **Cal Util Menu**
Recall Cal **yes**.

View calibration constant #463 (hardware configuration) again:

If a password is set, you must know it to do this step.

1. Press **PRESET** **SERVICE**.
2. Select **Adjust Menu**.
3. If **ENTER PASSWORD: 0** appears on the top line of the display:
 - a. Enter the password.
 - b. Press **ENTER**.
 - c. Select **Adjust Menu**.
4. Select **Calib Menu** **Select Cal**.
5. Press **463** **ENTER**.
6. Note the value of calibration constant #463.
Compare it to the following list.

HP 83621A; 30864

HP 83631A; 30864

HP 83651A; 32176

Is the synthesizer hardware configuration number correct?



ILT.7001

Since the hardware configuration number was incorrect in both the working memory and EEPROM, it is likely that this is not the only fault.

If you are *sure* the synthesizer hardware configuration number is *wrong*, continue with the following key sequence, otherwise go to paragraph ILT.113.

1. Select **Modify Cal**.
2. Input the correct calibration constant and press **ENTER**.
3. Select **Cal Util Menu Save Cal yes**.
4. Press **PRESET**.

Go to paragraph ILT.111.

ILT.7100

A custom or user preset can look like a failure especially if the user preset is mistakenly implemented instead of the factory preset. The following is a list of failures you might encounter and some possible causes to look for in a user preset:

Failures	Possible Causes
UNLOCK	External reference is selected, and: *External reference is not 10 MHz at 0 dBm. *External reference is not connected. *Reference is connected incorrectly.
UNLVLED LOW UNLVLED	External leveling is selected, and: *There is no external ALC input. *An improper external leveling point is selected. *The external ALC input is connected, but the RF source is turned off. *Leveling mode ALCoff is selected. *There is an improper combination of external ALC and ALC bandwidths.
Inaccurate RF Power	External leveling or AM selected, and: *ALC leveling search mode is selected. *AM is selected with dc levels at the AM input. *An instrument without a front panel has the RF output turned off.
Inaccurate Frequency	DC FM, frequency offset or multiplier is selected, and: *DC FM is selected with a dc voltage applied. *A frequency offset is selected. *A frequency multiplier is selected.
Sweep Does Not Function	Single or external sweep is selected, and: *External sweep trigger is selected. *An improper external trigger is selected. *Single sweep is selected.

Discontinue use of the user preset for the remainder of your troubleshooting. Go to ILT.112.

ILT.7500 The source module makes three connections with the HP 8360 series synthesizer:

- The source module interface.
- The RF output.
- The external ALC connection. This is the shielded connection that is part of the SMI connector.

If you are using a rear panel source module interface, go to ILT.7700.

If you are using a front panel source module interface, continue with ILT.7600.

ILT.7600 Using either an oscilloscope or a voltmeter, check the following voltages at the front panel SMI connector.

Location	Measurement
Pin 7	+5.2 Vdc
Pin 5	+15.0 Vdc
Pin 10, 18, 19, 20	TTL High

Did all voltages pass?

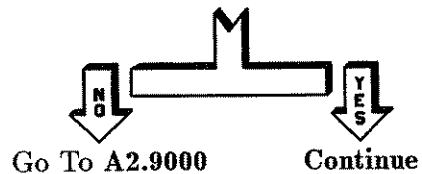

ILT.7601 Perform the following setup:

- Press **PRESET**.
- Press **SWEEP TIME** **10** **SEC**.

Using an oscilloscope or a voltmeter, check the following voltages on front panel SMI connector. Note that pin 12 is a sweep ramp. To adjust the sweep time, use the front panel controls (if you use an oscilloscope, try a sweep time of approximately 100 ms).

Location	Measurement
Pin 15	-15 Vdc
Pin 6	+8.0 Vdc
Pin 12	0 to 10V Sweep Ramp

Did all voltages pass?

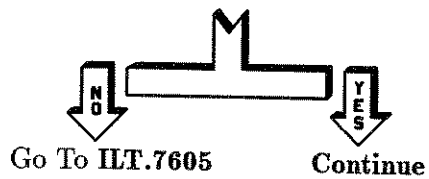

ILT.7602 Measure at the center pin at each end of the cable.

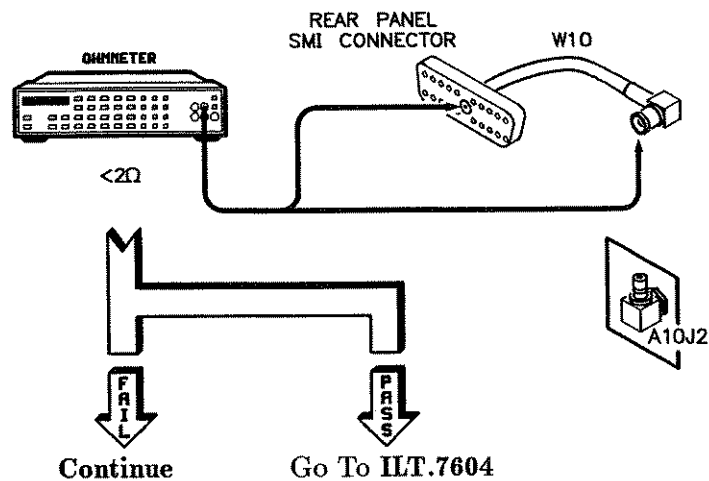

ILT.7603 Replace the cable (W10) that connects the front panel SMI input to the A10 assembly, and go to the Troubleshooting Foldout, block 1 (located just prior to the "Special Cases" tab).

ILT.7604 An SMI or ALC connection does not seem to be a problem. Go to paragraph ILT.7800.

ILT.7605 Either the front panel SMI (A2) or the ribbon cable (W10) is faulty. Inspect the ribbon cable. Replace the A2 assembly (go to A2.9000) or replace W10, as required, and go to the Troubleshooting Foldout, block 1 (located just prior to the "Special Cases" tab).

ILT.7700 Using either an oscilloscope or a voltmeter, check the following voltages at the rear panel SMI connector.

Location	Measurement
Pin 7	+5.2 Vdc
Pin 5	+15.0 Vdc
Pin 10, 18, 19, 20	TTL High

Did all voltages pass?

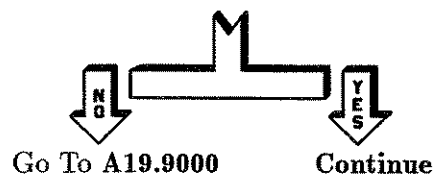

ILT.7701 Perform the following setup:

- Press **PRESET**.
- Press **SWEEP TIME** **10** **SEC**.

Using an oscilloscope or a voltmeter, check the following voltages on the rear panel SMI connector. Note that pin 12 is a sweep ramp. To adjust the sweep time, use the front panel controls (if you use an oscilloscope, try a sweep time of approximately 100 ms).

Location	Measurement
Pin 15	-15 Vdc
Pin 6	+8.0 Vdc
Pin 12	0 to 10V Sweep Ramp

Did all voltages pass?

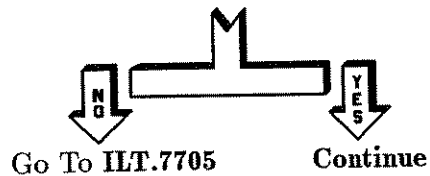

ILT.7702 Measure at the center pin at each end of the cable.

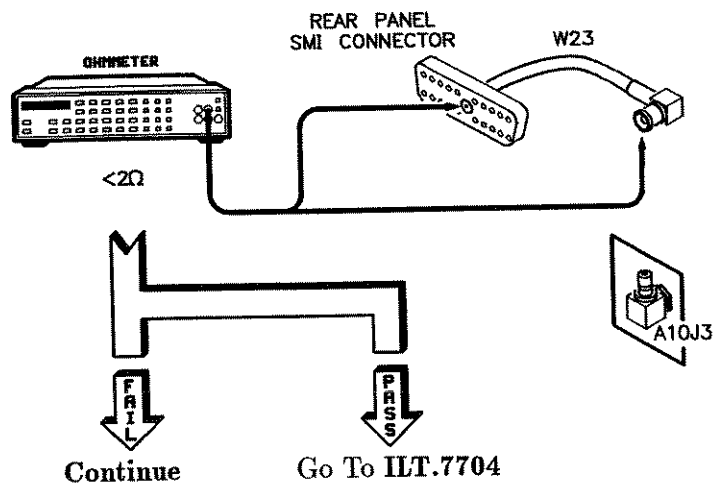

ILT.7703 Replace the cable (W23) that connects the rear panel SMI input to the A10 assembly, and go to the Troubleshooting Foldout, block 1 (located just prior to the "Special Cases" tab).

ILT.7704 An SMI or ALC connection does not seem to be a problem. Go to paragraph ILT.7800.

ILT.7705 Either the rear panel SMI (A19) or the ribbon cable (W23) is faulty. Inspect the ribbon cable. Replace the A19 assembly (go to A19.9000) or replace W23, as required, and go to the Troubleshooting Foldout, block 1 (located just prior to the "Special Cases" tab).

ILT.7800 Before performing this check, press **PRESET** **USER CAL** and select **FullUser Cal**. Wait until the instrument has completed the tracking process. Using the source module *User's Handbook* determine the range of frequencies and power levels provided by the synthesizer. Set the synthesizer for a manual sweep over the specified frequency range, at the specified power.

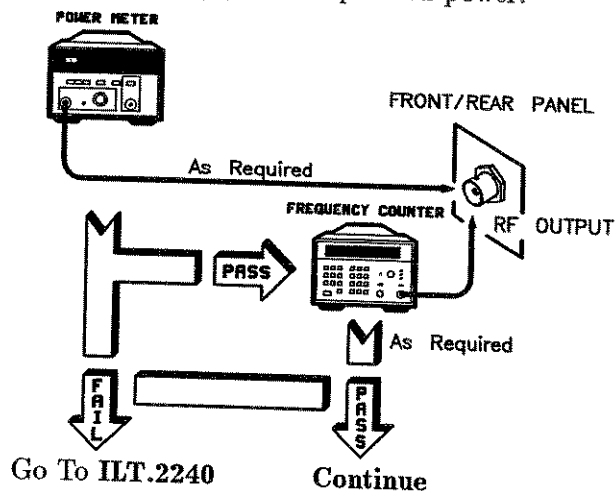

ILT.7801 Since the previous tests didn't clearly isolate the problem, the following is a prioritized list of the most likely causes of failure:

1. Using the source module *User's Handbook*, verify that the connections between the source module and the synthesizer are correct.
2. Front/Rear Panel SMI (A2, A19) is faulty.
3. W2 is faulty (connects the A2 assembly to the motherboard).

4. W31 is faulty (connects the A19 assembly to the motherboard).
5. The ALC assembly (A10) is faulty. This may be true only if leveling is the problem.
6. The source module is faulty. To confirm this, try to use the unused SMI connector, or substitute a new source module or synthesizer.
7. A remote possibility exists that the motherboard (A22) has a fault.

If these alternatives do not fix the problem, use the instrument block diagram (located at the end of “Special Cases”) to troubleshoot this problem.

ILT.8000

The best way to find network analyzer problems is by testing the input and output ports. To do this, refer to paragraph ILT.3000. Each port is listed and can be tested separately. The ports of interest in a network analyzer will most likely be the following:

- For instruments using Analyzer language, set the switch to 1 (binary 001). If the instrument is used with HP 8510 systems, either set the language part of the switch to 1 or set the language to Analyzer language at the front panel. This also applies to systems that depend on HP 8340/8341 compatibility.
- Concerning the address switches, the HP 8510 (and other systems) assume that the HP-IB address is 19 (binary 10011).
- Using the network analyzer's *On-Site Service Handbook* verify that all connections between the HP 8510 and the other instruments are correct.
- RF output.
- Stop sweep in/out.
- Sweep output.
- Trigger output.
- HP-IB.
- Front or rear panel source module interface.
- Auxillary Interface.

If these alternatives do not fix the problem, use the instrument block diagram (located at the end of "Special Cases") to troubleshoot this problem.

A1 Front Panel Keyboard Troubleshooting

A1.000

When the full self-tests are run (from the service menu) the keyboard test is not run. Only the keyboard to A3 interface is tested. To test the keyboard, run the following test.

Perform the following key sequence:

1. Press **PRESET** **SERVICE**.
2. Select **Selftest Menu**.
3. Press **21** **ENTER**.
4. Select **Do Test #21**.

On the display you will see a dash (—) corresponding to each front panel softkey and hardkey (except for **PRESET**). Pressing a key causes the corresponding dash to toggle to an 'X'. Each successive key press toggles the 'X' to the dash and back. In addition, the rotary knob (RPG) toggles the two dashes in the upper right hand corner of the display. The one that toggles depends on the direction the RPG is turned.

To exit the test, press **PRESET**.

If this test fails (the key press does not cause a toggle to occur), you may still have a good keyboard. The front panel processor provides the interface between the keyboard and the rest of the instrument. A bad interface could cause this test to fail. Go to A3.000 to check the A3 to A1 interface.

A1.9000

Replace the A1 assembly.

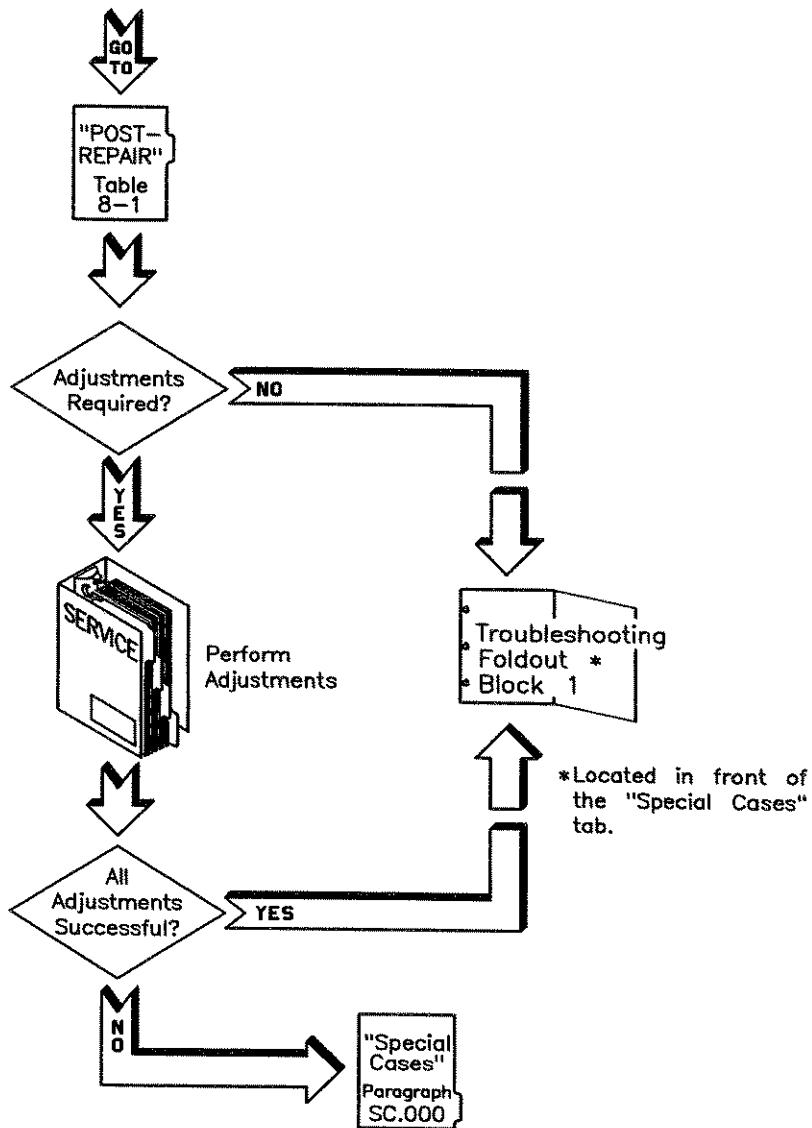

A2 Source Module Interface Troubleshooting

A2.000

Message Displayed on Synthesizer

**Go to
Paragraph**

A2 : LED Control Latch

A2.100

A2 : SMI Control Latch

A2.200

A2 : SMI Sensing Circuit

A2.8000

A2.100

A22J1 is located at the very front of the instrument on the motherboard. Early versions of the A22J1 (motherboard) pins *may* be mislabeled. The square pad correctly indicates pin 1.

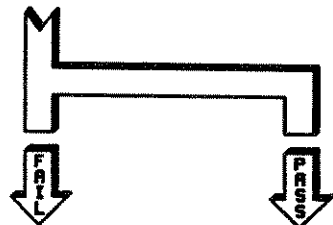
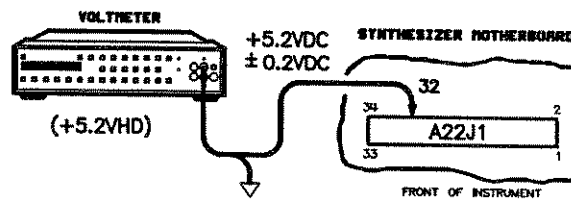

Go To A2.1300

Continue

A2.101 Loop self-test #232:

1. Press **PRESET** **SERVICE**.
2. Select **Selftest Menu**.
3. Press **232** **ENTER**.
4. Select **Loop Do Test #232**.

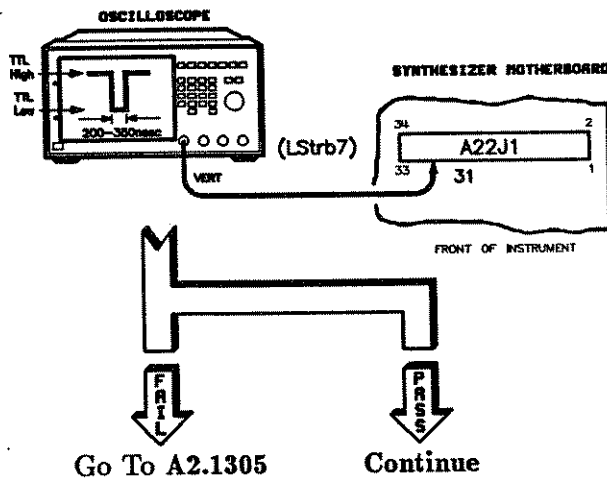

A2.103 Loop self-test #233:

1. Press **PRESET** **SERVICE**.
2. Select **Selftest Menu**.
3. Press **233** **ENTER**.
4. Select **Loop Do Test #233**.

Check *all* signals listed below for *TTL pulses* at A22J1. A22J1 is located at the very front of the instrument on the motherboard. Early versions of the A22J1 (motherboard) pins *may* be mislabeled. The square pad correctly indicates pin 1.

Signal	Location
DB0	A22J1-22
DB1	A22J1-21
DB2	A22J1-20
DB3	A22J1-19
DB4	A22J1-18
DB5	A22J1-17
DB6	A22J1-16
DB7	A22J1-15

If one or more signals do *not* have *TTL pulses*, the test has failed. If *all* signals have *TTL pulses*, the test has passed.

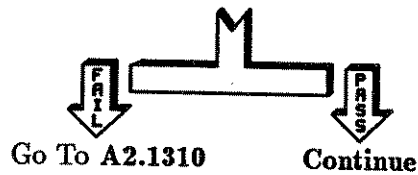

A2.104 Loop self-test #231:

1. Press **PRESET** **SERVICE**.
2. Select **Selftest Menu**.
3. Press **231** **ENTER**.
4. Select **Loop Do Test #231**.

Signal	Location
AB2	A22J1-28
AB3	A22J1-27
AB4	A22J1-26
AB5	A22J1-25
AB6	A22J1-23

If one or more signals do *not* have *TTL pulses*, the test has failed. If *all* signals have *TTL pulses*, the test has passed.

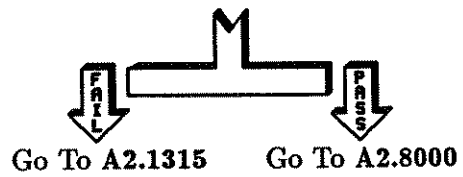

A2.200

A22J1 is located at the very front of the instrument on the motherboard. Early versions of the A22J1 (motherboard) pins *may* be mislabeled. The square pad correctly indicates pin 1.

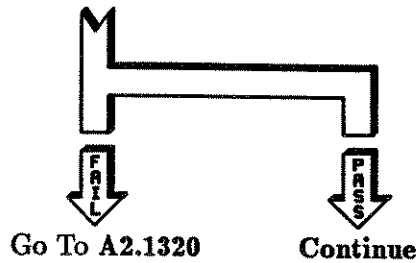
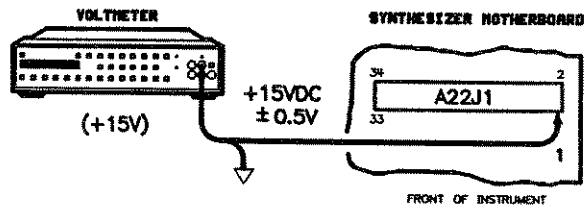

A2.201

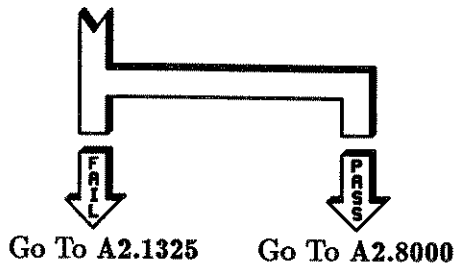
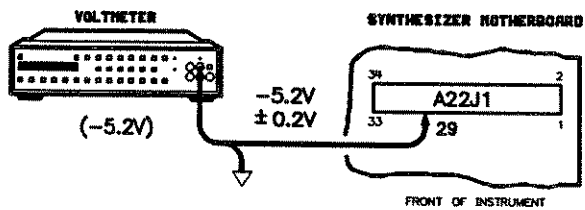

A2.1300

There is an open on the motherboard between A22J1-32 and XA17J1-4, 5, 6, 34, 35, or 36. Verify this with an ohmmeter. Is jumpering an acceptable repair?

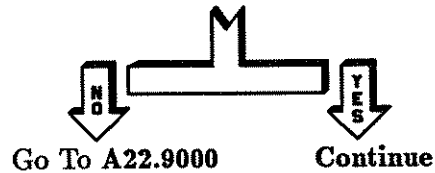

A2.1301 Install a jumper. Then go to the Troubleshooting Foldout, block 1 (located just prior to the "Special Cases" tab).

A2.1305

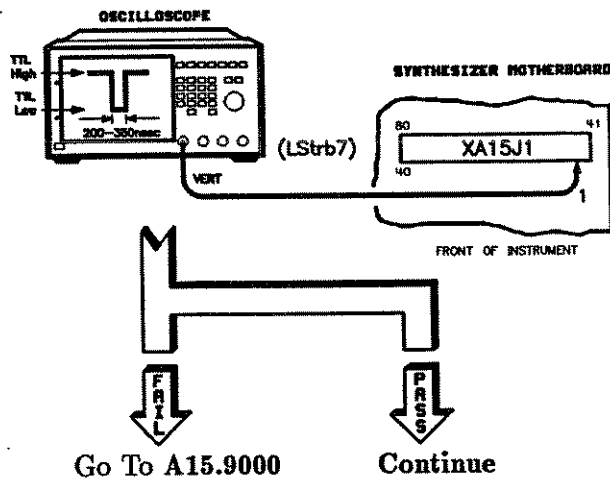

- A2.1306** There is an open on the motherboard between A22J1-31 and XA15J1-1. Verify this with an ohmmeter. Is jumpering an acceptable repair?

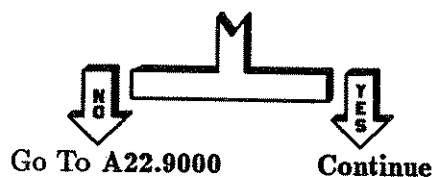

- A2.1307** Install a jumper. Then go to the Troubleshooting Foldout, block 1 (located just prior to the "Special Cases" tab).

- A2.1310** Check *all* signals listed below for *TTL pulses* at XA15J1.

Signal	Location
DB0	XA15J1-12
DB1	XA15J1-52
DB2	XA15J1-13
DB3	XA15J1-53
DB4	XA15J1-14
DB5	XA15J1-54
DB6	XA15J1-15
DB7	XA15J1-55

If one or more signals do *not* have *TTL pulses*, the test has failed. If *all* signals have *TTL pulses*, the test has passed.

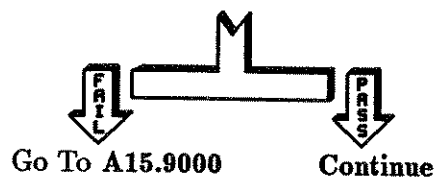

- A2.1311** There is an open on the motherboard data bus between A22J1 and XA15J1. Verify this with an ohmmeter. Is jumpering an acceptable repair?

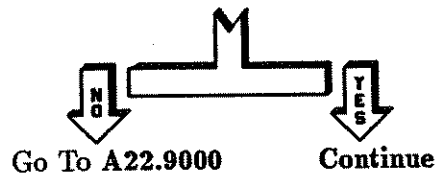

- A2.1312** Select the failing signals and install jumpers as required.

Signal	A2 Location	A15 Location
DB0	A22J1-22	XA15J1-12
DB1	A22J1-21	XA15J1-52
DB2	A22J1-20	XA15J1-13
DB3	A22J1-19	XA15J1-53
DB4	A22J1-18	XA15J1-14
DB5	A22J1-17	XA15J1-54
DB6	A22J1-16	XA15J1-15
DB7	A22J1-15	XA15J1-55

When the repair is complete, go to the Troubleshooting Foldout, block 1 (located just prior to the "Special Cases" tab).

- A2.1315** Check *all* signals listed below for *TTL pulses* at XA15J1.

Signal	Location
AB2	XA15J1-8
AB3	XA15J1-48
AB4	XA15J1-9
AB5	XA15J1-49
AB6	XA15J1-10

If one or more signals do *not* have *TTL pulses*, the test has failed. If *all* signals have TTL pulses, the test has passed.

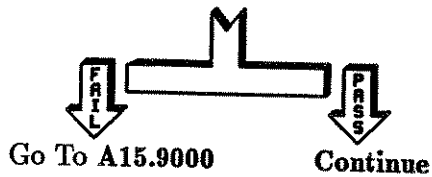

- A2.1316** There is an open on the motherboard data bus between A22J1 and XA15J1. Verify this with an ohmmeter. Is jumpering an acceptable repair?

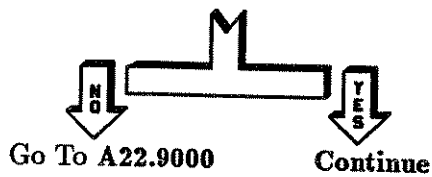

- A2.1317** Select the failing signals and install jumpers as required.

Signal	A2 Location	A15 Location
AB2	A22J1-28	XA15J1-8
AB3	A22J1-27	XA15J1-48
AB4	A22J1-26	XA15J1-9
AB5	A22J1-25	XA15J1-49
AB6	A22J1-23	XA15J1-10

When the repair is complete, go to the Troubleshooting Foldout, block 1 (located just prior to the "Special Cases" tab).

A2.1320

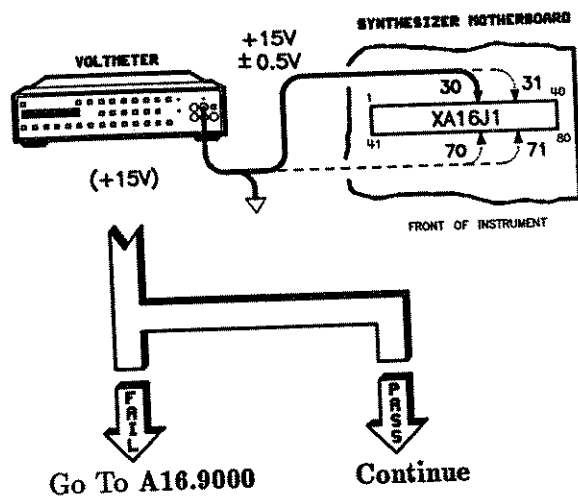

A2.1321 There is an open on the motherboard between A22J1-1 and XA16J1-30, 31, 70, or 71. Verify this with an ohmmeter. Is jumpering an acceptable repair?

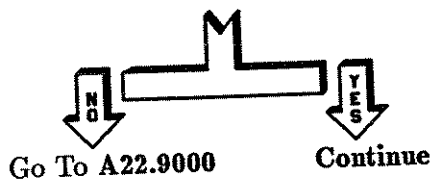

A2.1322 Install a jumper. Then go to the Troubleshooting Foldout, block 1 (located just prior to the "Special Cases" tab).

A2.1325

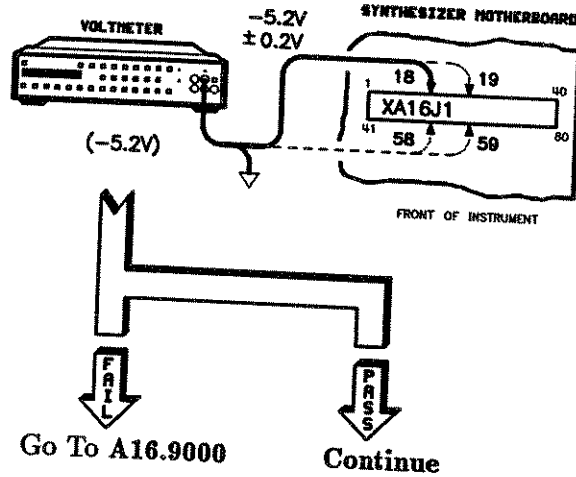

A2.1326

There is an open on the motherboard between A22J1-29 and XA16J1-18, 19, 58, or 59. Verify this with an ohmmeter. Is jumpering an acceptable repair?

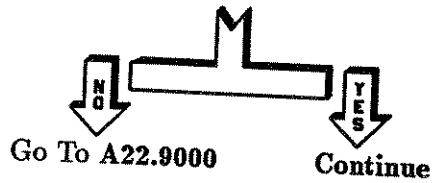

A2.1327

Install a jumper. Then go to the Troubleshooting Foldout, block 1 (located just prior to the "Special Cases" tab).

A2.8000

Perform the following tasks:

1. Remove front panel.
2. Completely remove W2 (W2 connects A2 to the motherboard).
3. Using an ohmmeter, check W2.

Is W2 Faulty?

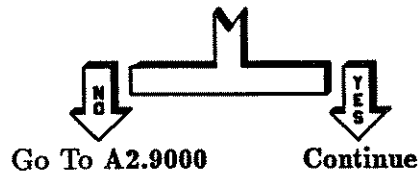
**A2.8500**

Replace W2. You may want to consider replacing the A2 assembly. Then go to Troubleshooting Foldout, block 1 (located just prior to the "Special Cases" tab).

A2.9000

Replace the A2 assembly.

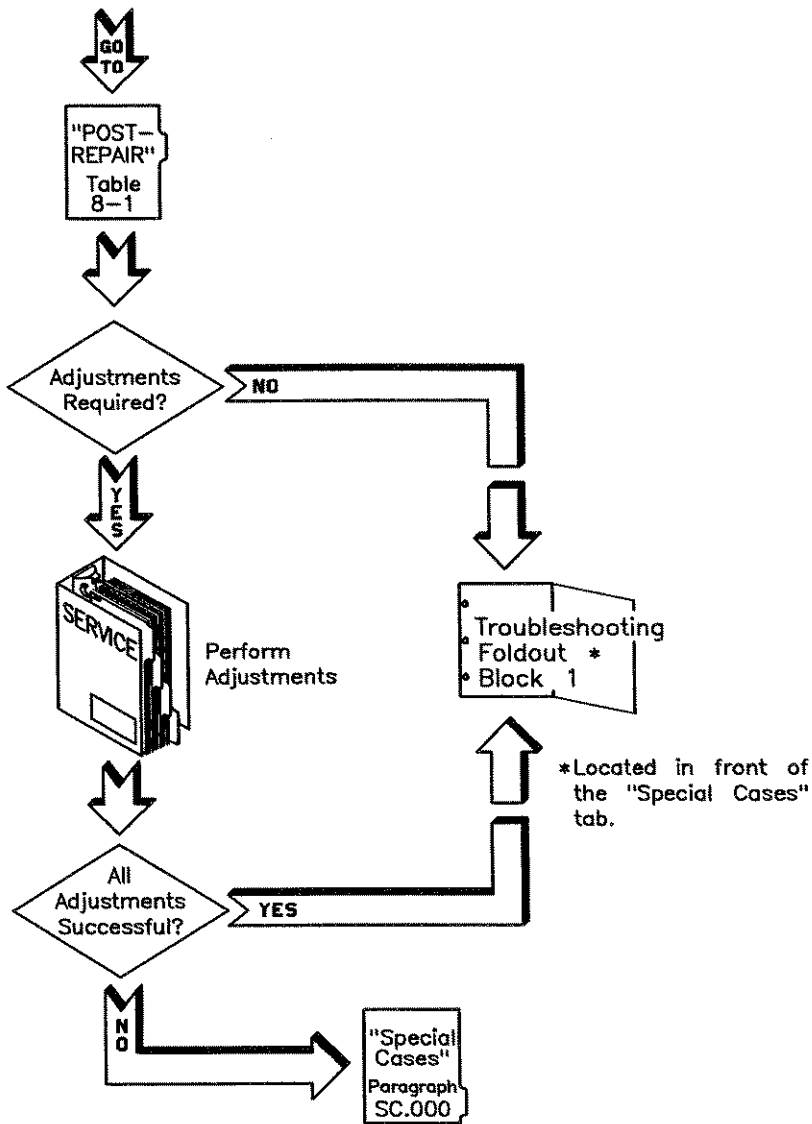

A3 Front Panel Processor Troubleshooting

A3.000

The front panel processor (A3) serves as an interface between the rest of the instrument and the display (A21) and keyboard (A1). Go to A21.000 for display testing. Keyboard testing is given in A1.000, however, the following is an additional test that checks whether the keyboard can communicate with the front panel processor.

Perform the following key sequence:

1. Turn the line power switch to ON.
2. Press **PRESET** and any other key together.
3. Release **PRESET** and then release the other key.
4. Look at the top edge of the front panel processor just to the left of the rotary knob (RPG). A series of six indicators should be visible. To observe the data interchange between the keyboard and the front panel processor, press a key and you should see the key code change. The indicators should change each time you press a different key.

The following selected key sequences do a good job of checking the interface between A3 and A1. If these (or others) are faulty the problem will be A3, A1, or the connecting ribbon cable (W5).

Key	Indicators ¹
9	101 101
CENTER	010 010
First (left-most) Softkey	100 000
Second Softkey	010 000
Third Softkey	110 000
Fourth Softkey	001 000
Fifth Softkey	101 000
ENTRY ON/OFF	000 001
CW	000 010
USER DEFINED MENU	000 100
PRIOR	111 110
SYSTEM RECALL	011 011

1 1=ON, 0=OFF

A3.9000

Replace the A3 assembly.

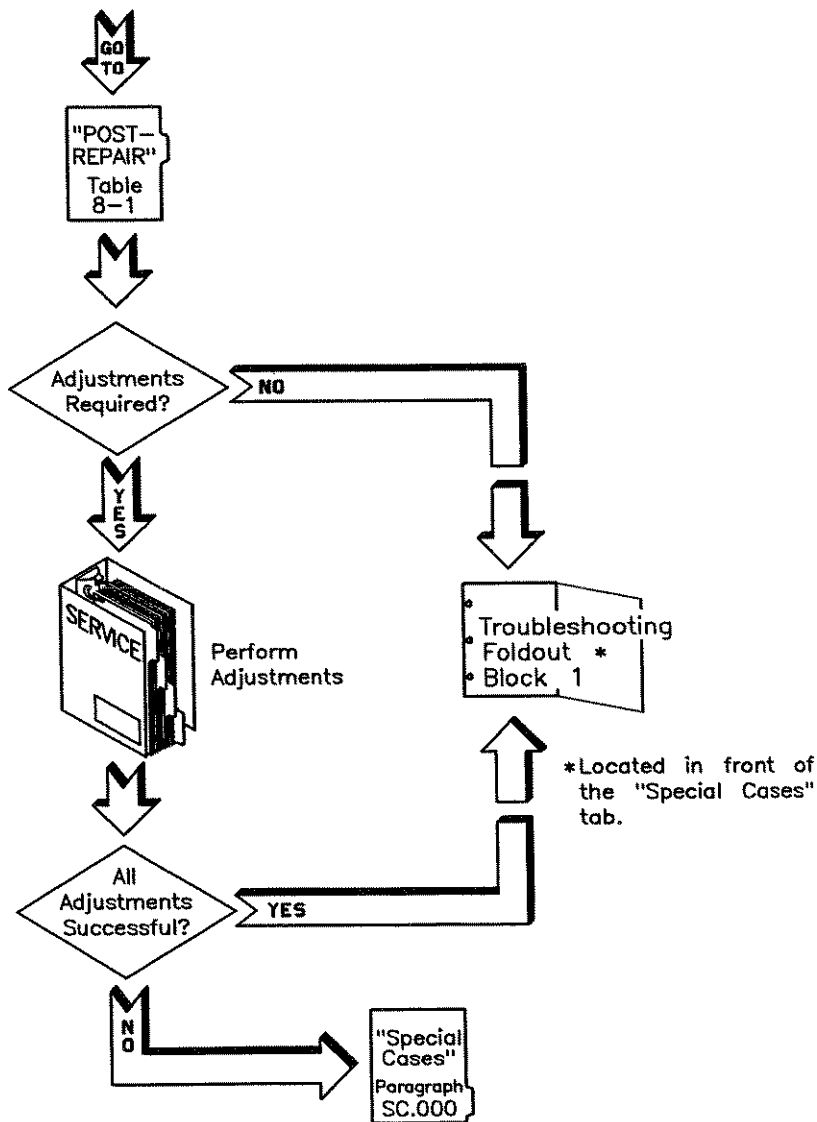

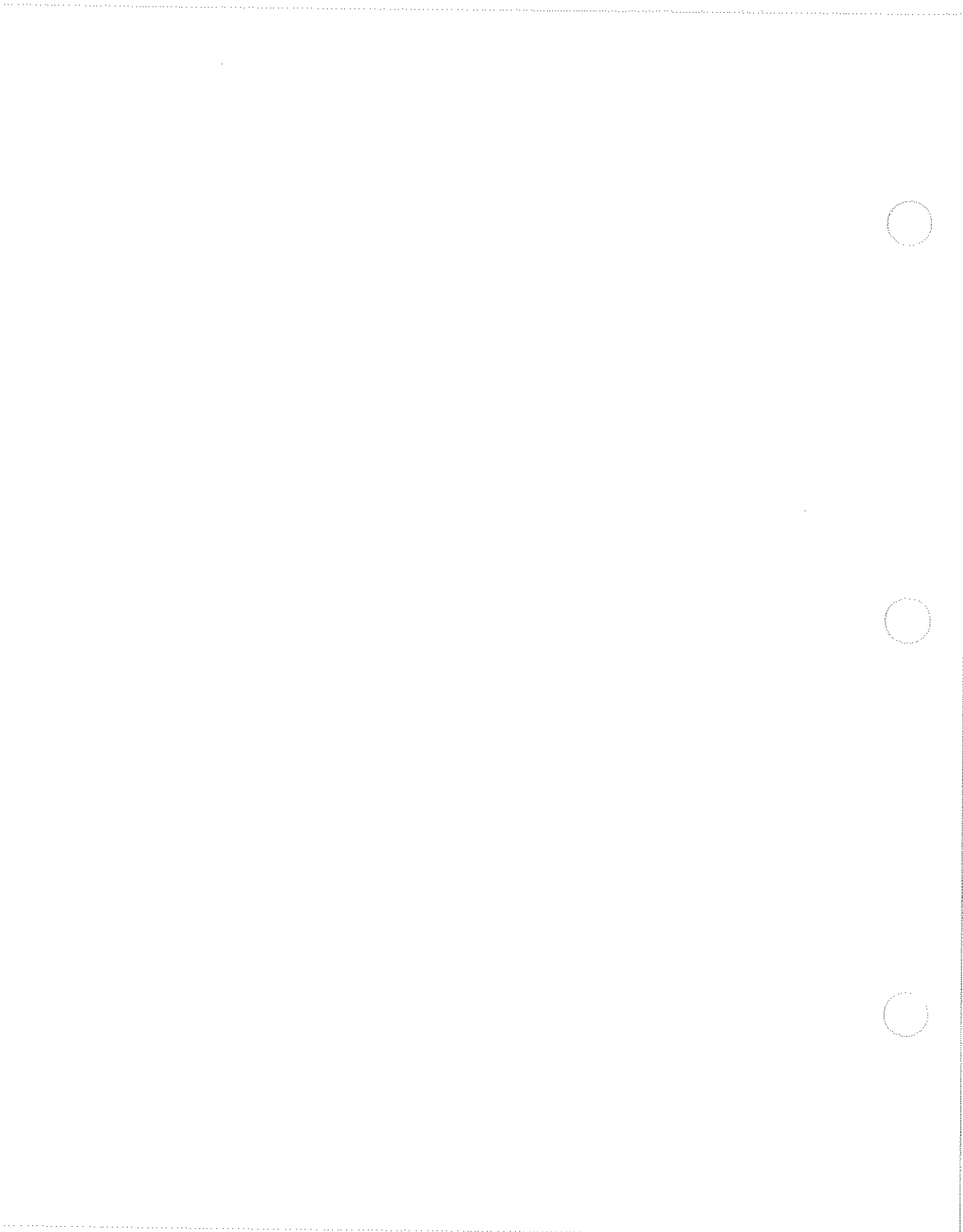

A4 Fractional-N Troubleshooting

A4.000	Message Displayed on Synthesizer	Go to Paragraph
	A4 : Read Buffers	A4.100
	A4 : -3.25V Supply	A4.200
	A4 : Tuning Range	A4.300
	A4 : FNGO Control	A4.400
	A4 : D-REF Supply	A4.9000
	A4 : FN Chip Registers	A4.9000
	A4 : +2.2V Supply	A4.9000
	A4 : Sweep Test	A4.9000
	A4 : Switching Speed	A4.9000
	A4 : Monotonicity	A4.9000

A4.100

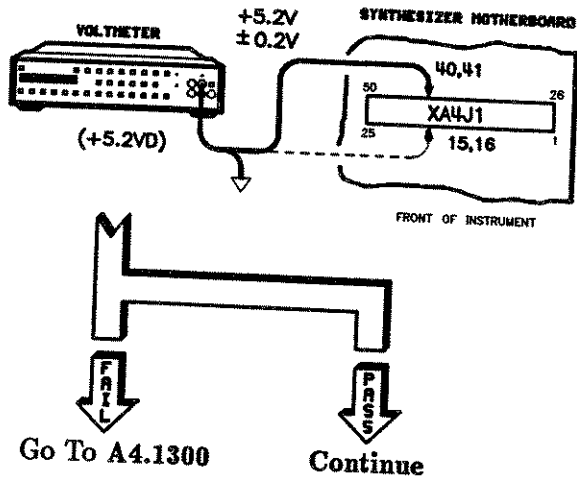

A4.101

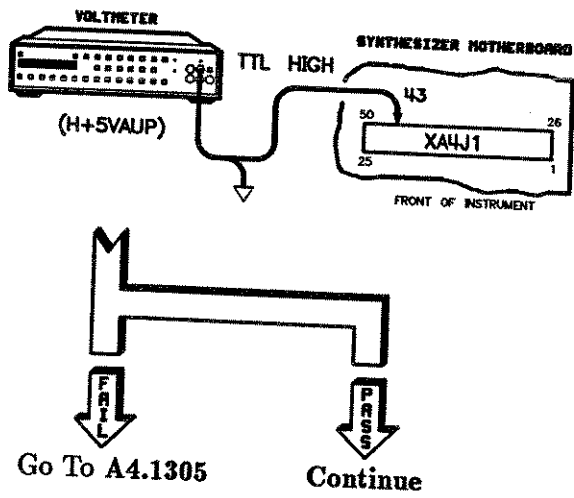

A4.102 Loop self-test #232:

1. Press **PRESET** **SERVICE**.
2. Select **Selftest Menu**.
3. Press **232** **ENTER**.
4. Select **Loop Do Test #232**.

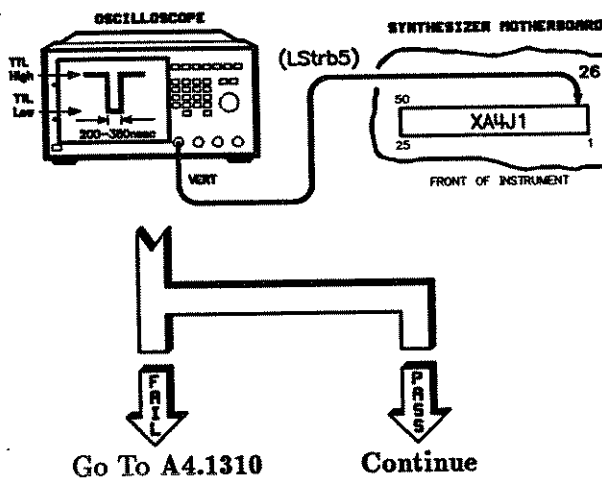

A4.103 Loop self-test #231:

1. Press **PRESET** **SERVICE**.
2. Select **Selftest Menu**.
3. Press **231** **ENTER**.
4. Select **Loop Do Test #231**.

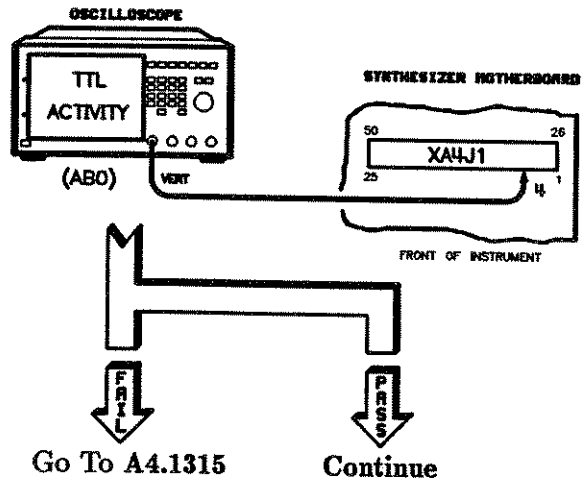

A4.104

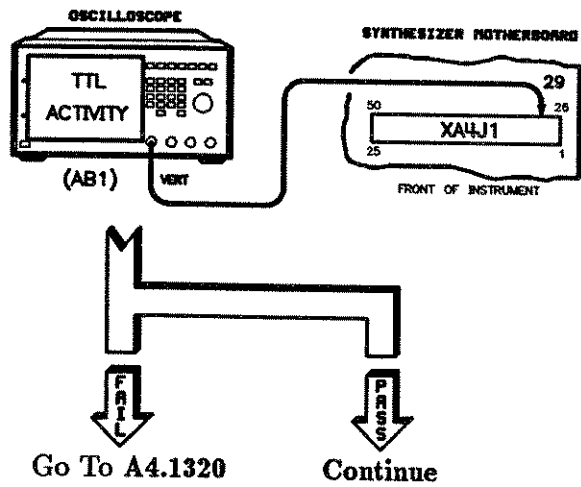

A4.105

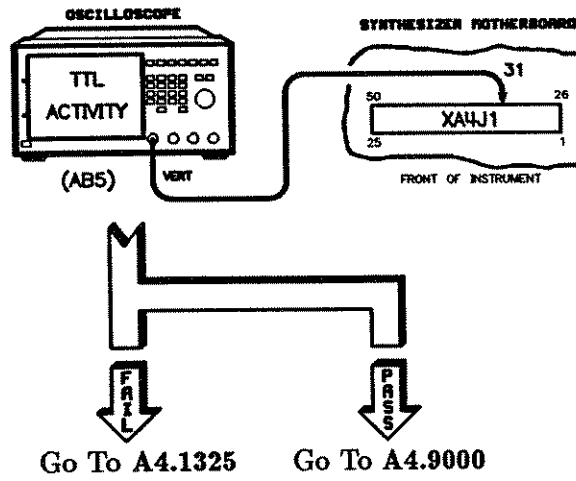

A4.200

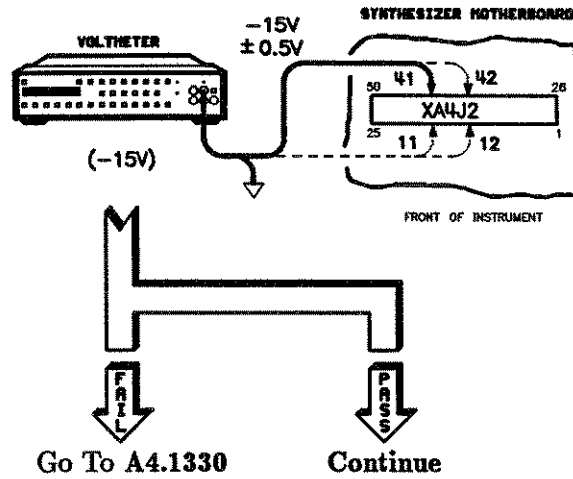

A4.201

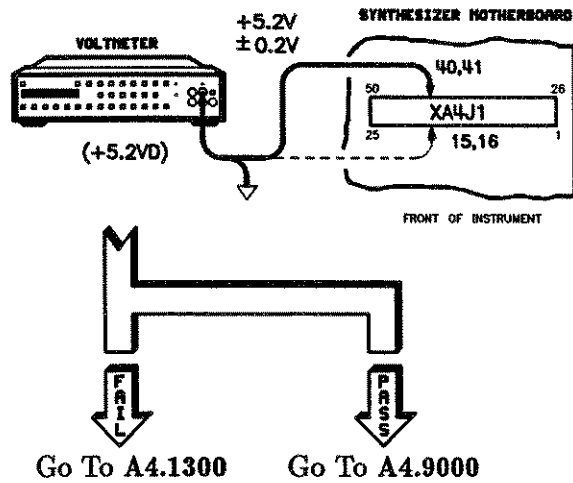

A4.300

The pulse width is 10 to 20 ns. The frequency is 125 kHz. The oscilloscope must present a 50Ω load. Do not use a high impedance probe. The combination of low frequency and narrow pulse width makes this a very difficult pulse to see. Do not use a frequency counter to check frequency, because of the tendency to count the second harmonic.

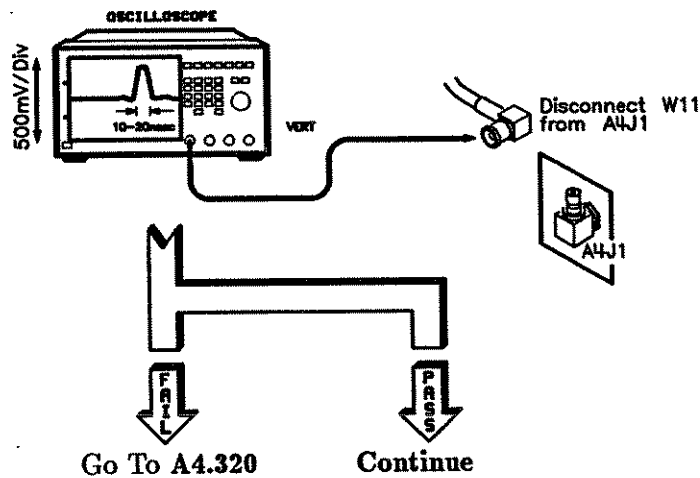

A4.301 Perform the following setup:

1. Turn the synthesizer off.
2. Remove the A4 assembly.
3. Turn the synthesizer on.
4. Press **PRESET** **CW** **SERVICE**.
5. Select Unlock Info.

Does FRACN indicate OK?

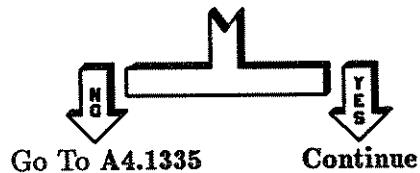

A4.302 Perform the following setup:

1. Carefully short XA4J1-50 to ground (A4 should still be removed).
2. Select **Unlock Info** **Unlock Info** (press **Unlock Info** twice to reacquire data).

Does FRACN indicate UNLOCK?



Go To A4.1335

Continue

A4.303 Perform the following setup:

1. Turn the synthesizer off.
2. Re-install the A4 assembly and reconnect the cables.
3. Turn the synthesizer on.

Loop self-test #35:

1. Press **PRESET** **SERVICE**.
2. Select **Selftest Menu**.
3. Press **35** **ENTER**.
4. Select **Loop** **Do Test #35**.

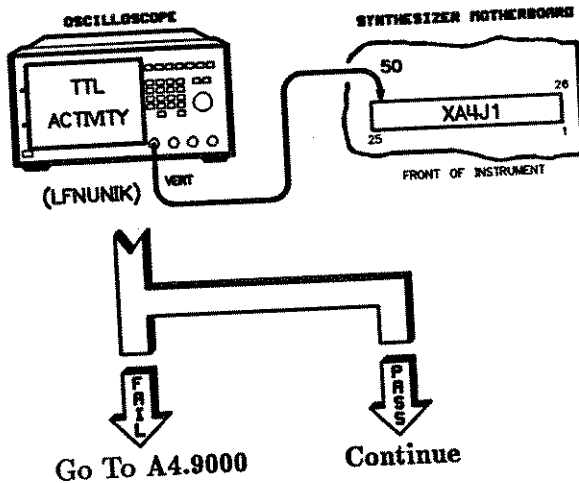

A4.304 Perform the following setup:

1. Press **PRESET** **SERVICE**.
2. Select **Adjust Menu** **AssyAdj Menu**.
3. Select **A4 VCO Tune**.

Is the adjustment needle in the middle third of the synthesizer display?

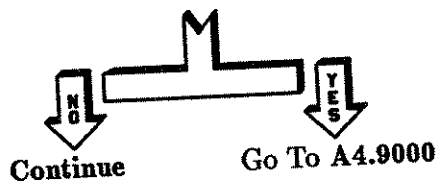

A4.305 Try to execute the A4 VCO tune adjustment (refer to "Adjustments" in the *Service* manual) and then continue.

Was the adjustment successful?

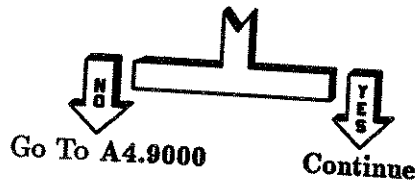

A4.306 Do self-test #29:

1. Press **PRESET** **SERVICE**.
2. Select **Selftest Menu**.
3. Press **29** **ENTER**.
4. Select **Do Test #29**.

Did self-test #29 pass?

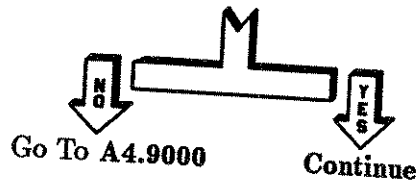

A4.307 The adjustment may have repaired the A4 assembly. Go to "Instrument Level Troubleshooting."

A4.320 The pulse width is 10 to 20 ns. The frequency is 125 kHz. The oscilloscope must present a 50Ω load. Do not use a high impedance probe. The combination of low frequency and narrow pulse width makes this a very difficult pulse to see. Do not use a frequency counter to check frequency, because of the tendency to count the second harmonic.

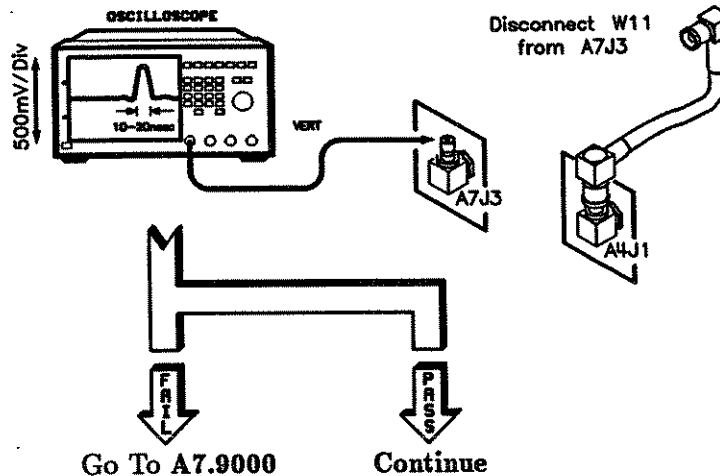

A4.321 Replace W11 (A7J3 to A4J1) and go to the Troubleshooting Foldout, block 1 (located just prior to the "Special Cases" tab).

A4.400

Loop self-test #37:

1. Press **PRESET** **SERVICE**.
2. Select **Selftest Menu**.
3. Press **37** **ENTER**.
4. Select **Loop Do Test #37**.

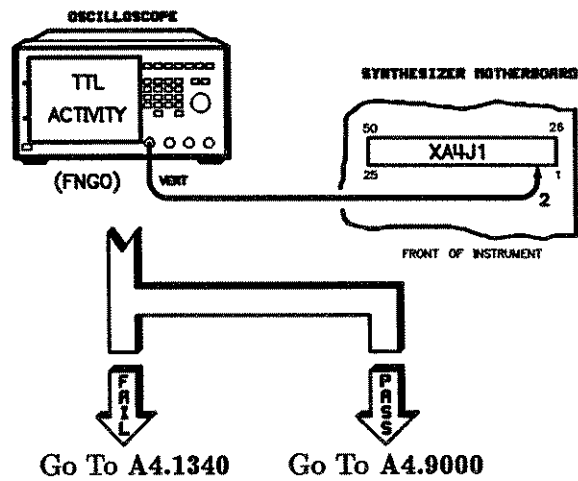

A4.1300

There is an open on the motherboard between XA4J1-15, 16, 40, or 41 and XA7J1-15, 16, 40, or 41. Verify this with an ohmmeter. Is jumpering an acceptable repair?

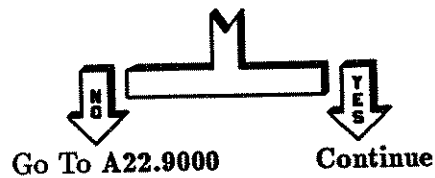

A4.1301 Install a jumper and go to the Troubleshooting Foldout, block 1 (located just prior to the "Special Cases" tab).

A4.1305 There is an open on the motherboard between XA4J1-43 and XA7J1-43. Verify this with an ohmmeter. Is jumpering an acceptable repair?

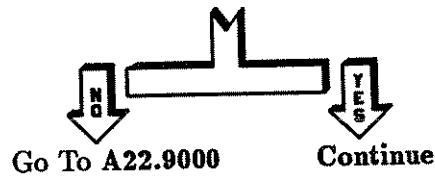

A4.1306 Install a jumper and go to the Troubleshooting Foldout, block 1 (located just prior to the "Special Cases" tab).

A4.1310

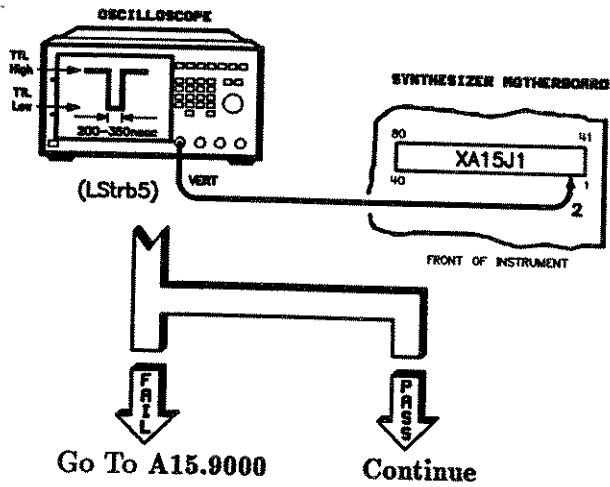

A4.1311 There is an open on the motherboard between XA4J1-26 and XA15J1-2. Verify this with an ohmmeter. Is jumpering an acceptable repair?

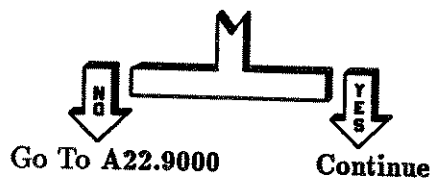

A4.1312 Install a jumper and go to the Troubleshooting Foldout, block 1 (located just prior to the "Special Cases" tab).

A4.1315

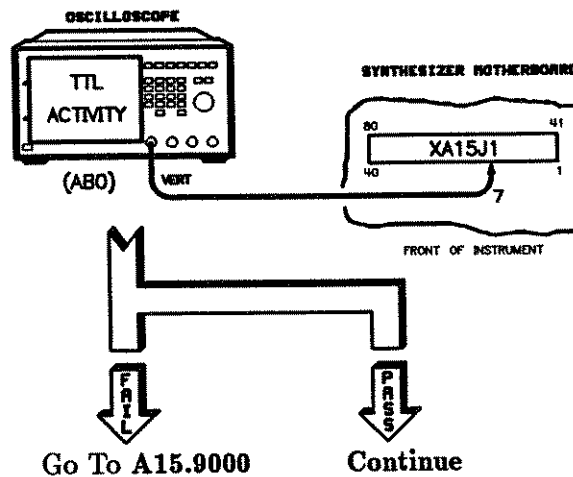

A4.1316 There is an open on the motherboard between XA4J1-4 and XA15J1-7. Verify this with an ohmmeter. Is jumpering an acceptable repair?

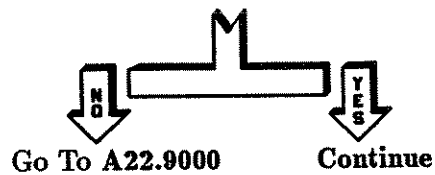

A4.1317 Install a jumper and go to the Troubleshooting Foldout, block 1 (located just prior to the "Special Cases" tab).

A4.1320

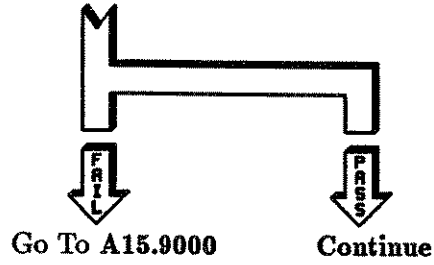
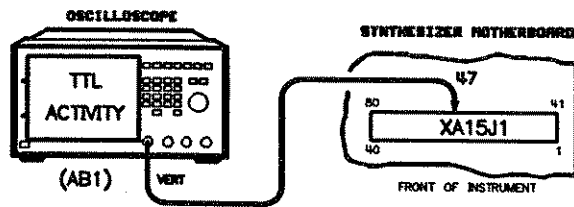

A4.1321 There is an open on the motherboard between XA4J1-29 and XA15J1-52. Verify this with an ohmmeter. Is jumpering an acceptable repair?

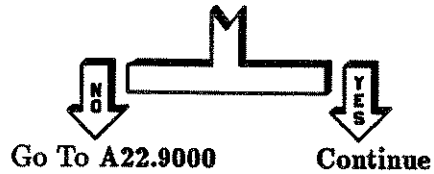

A4.1322 Install a jumper and go to the Troubleshooting Foldout, block 1 (located just prior to the "Special Cases" tab).

A4.1325

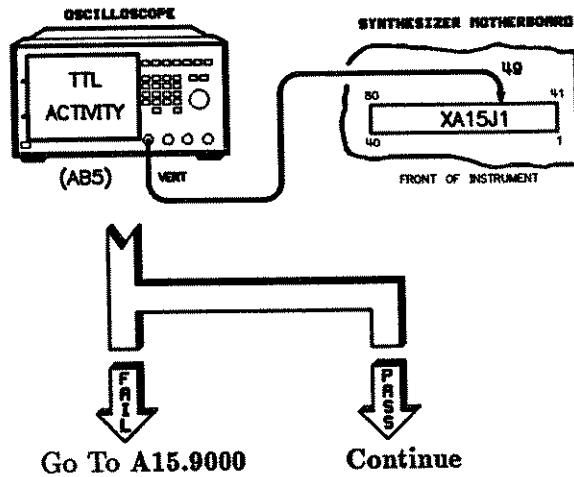

A4.1326

There is an open on the motherboard between XA4J1-31 and XA15J1-49. Verify this with an ohmmeter. Is jumpering an acceptable repair?

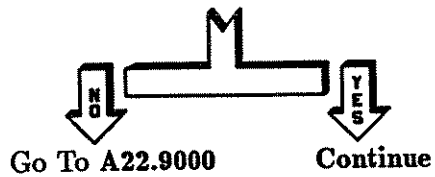

A4.1327

Install a jumper and go to the Troubleshooting Foldout, block 1 (located just prior to the "Special Cases" tab).

- A4.1330** There is an open on the motherboard between XA4J2-11, 12, 41, or 42 and XA7J2-11, 12, 41, or 42. Verify this with an ohmmeter. Is jumpering an acceptable repair?

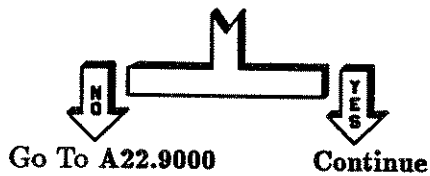

- A4.1331** Install a jumper and go to the Troubleshooting Foldout, block 1 (located just prior to the "Special Cases" tab).

- A4.1335** Using an ohmmeter, measure the resistance from XA4J1-50 to XA15J1-77.

Is the resistance less than or equal to 2Ω ?

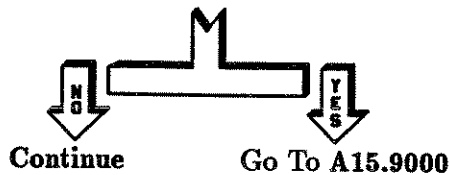

- A4.1336** There is an open on the motherboard between XA4J1-50 and XA15J1-77. Verify this with an ohmmeter. Is jumpering an acceptable repair?

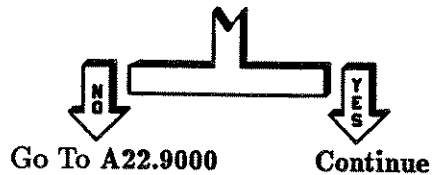

- A4.1337** Install a jumper and go to the Troubleshooting Foldout, block 1 (located just prior to the "Special Cases" tab).

A4.1340

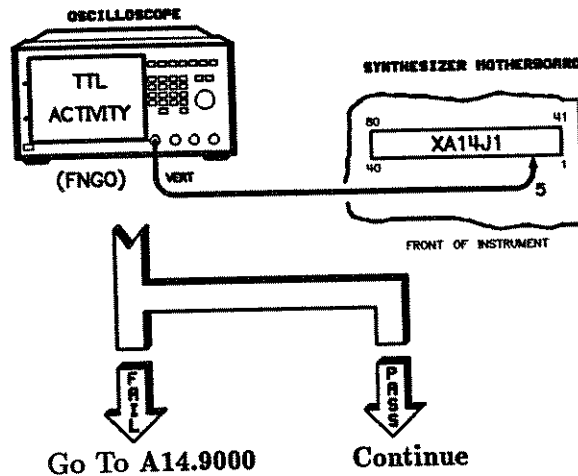

- A4.1341** There is an open on the motherboard between XA4J1-2 and XA14J1-5. Verify this with an ohmmeter. Is jumpering an acceptable repair?

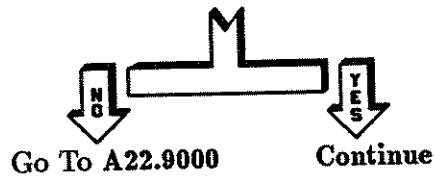

- A4.1342** Install a jumper and go to the Troubleshooting Foldout, block 1 (located just prior to the "Special Cases" tab).

A4.9000

Replace the A4 assembly.

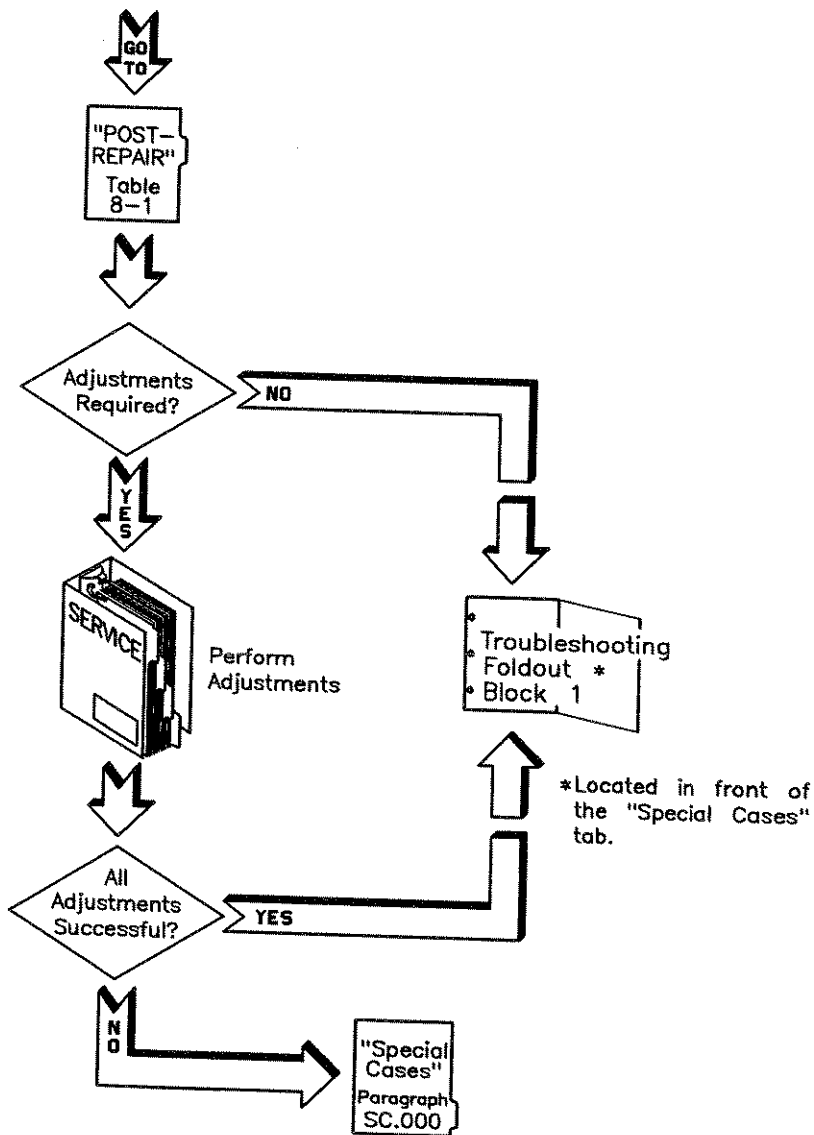

A5 YO Loop Troubleshooting

A5.000	Message Displayed on Synthesizer	Go to Paragraph
	A5 : Digital Interface	A5.100
	A5 : ABUS Ground	A5.200
	A5 : Switched Amplifier	A5.300
	A5 : IF Frequency Counter	A5.400
	A5 : Integrator	A5.500
	A5 : Overmod Detector	A5.600
	A5 : Phase Detector	A5.8500
	A5 : Output to YO Driver	A5.8500
	A5 : Output to FM Coil	A5.8500
	A5 : Track and Hold	A5.8500

A5.100 Perform the following key sequence:

1. Press **PRESET** **SERVICE**.
2. Select **Selftest Menu**.
3. Press **231** **ENTER**.
4. Select **Loop** (asterisk on).
5. Select **Do Test #231**.

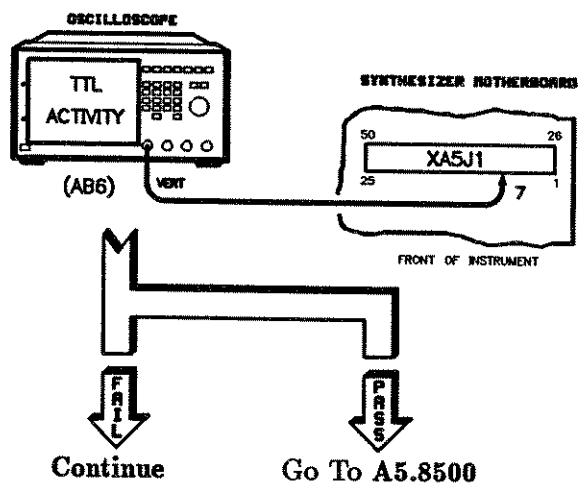

A5.110

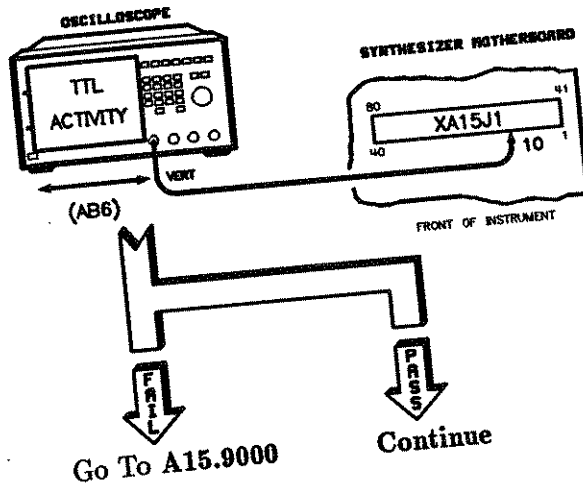

A5.111 There is an open on the motherboard between XA5J1-7 and XA15J1-10. Verify this with an ohmmeter. Is jumpering the open an acceptable repair?

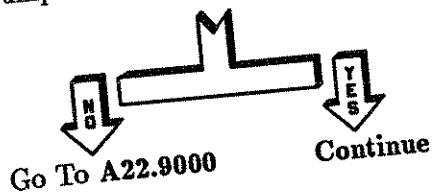

A5.112 Install a jumper and go to the Troubleshooting Foldout, block 1 (located just prior to the "Special Cases" tab).

A5.200 Perform the following key sequence:

1. Press **PRESET** **SERVICE** **CW**.
2. Select **Selftest Menu**.
3. Press **49** **ENTER**.
4. Select **Loop** (asterisk on).
5. Select **Do Test #49**.

Verify that portions of the signal are ≤ 700 mV.
 However, expect other portions of the signal to rise to levels of up to 15 Vdc. This is not a failure as long as portions of the signal are ≤ 700 mV.

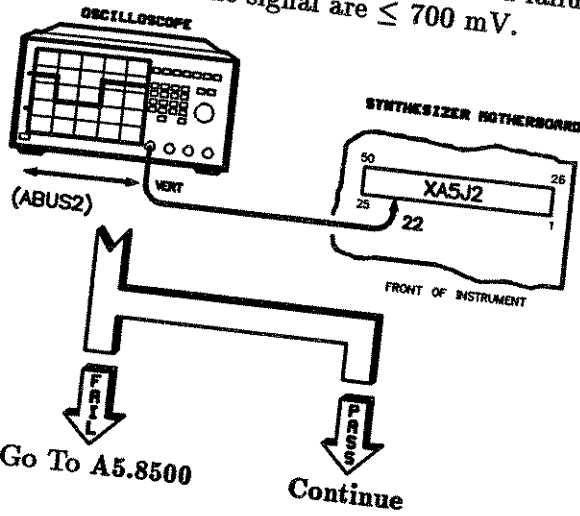

A5.220 Verify that portions of the signal are ≤ 700 mV.
 However, expect some portions of the signal to rise to levels of up to 15 Vdc. This is not a failure as long as portions of the signal are ≤ 700 mV.

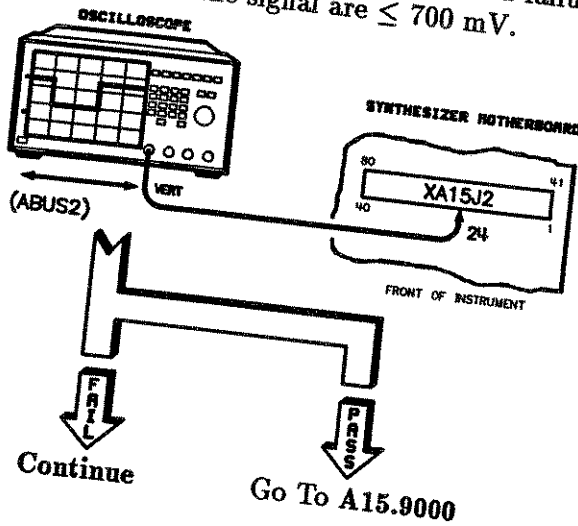

- A5.221** There is an open on the motherboard between XA5J2-22 and XA15J2-24. Verify this with an ohmmeter. Is jumpering the open an acceptable repair?

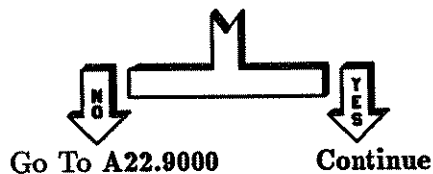

- A5.222** Install a jumper and go to the Troubleshooting Foldout, block 1 (located just prior to the "Special Cases" tab).

- A5.300** The instrument may be showing an UNLOCK message. If so, the keyboard response will be very sluggish. This is normal. Also, the frequency may be somewhat unstable.

Perform the following key sequence:

1. Press **PRESET** **SERVICE**.
2. Select **Tools Menu** **CntlPLL Menu** **Sampler Menu** **Sampler Freq.**
3. Press **200** **MHz**.

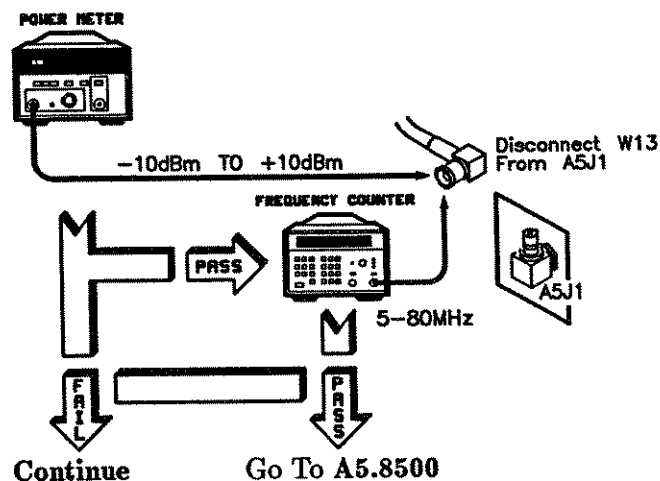

A5.301

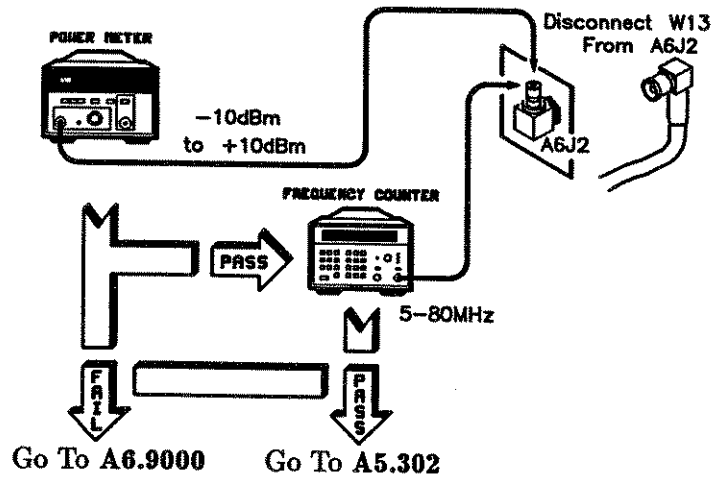

A5.302 Replace W13 and go to the Troubleshooting Foldout, block 1 (located just prior to the “Special Cases” tab).

A5.400 Perform the following key sequence:

1. Press **PRESET** **CW** **SERVICE**.
2. Select **Selftest Menu**.
3. Press **51** **ENTER**.
4. Select **Loop** (asterisk on)
5. Select **Do Test #51**.

Note that this TTL signal cycles about every one to three seconds. It is a low duty cycle, low frequency signal that is difficult to see.

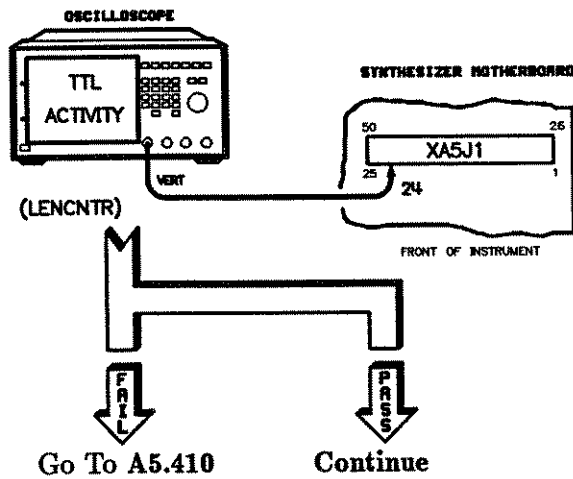

A5.401 Set up the following measurement and look for a very slow-moving TTL signal.

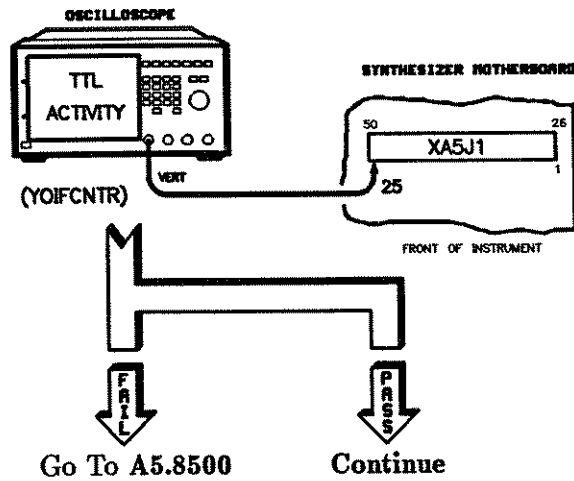

- A5.402** Set up the following measurement and look for a very slow-moving TTL signal.

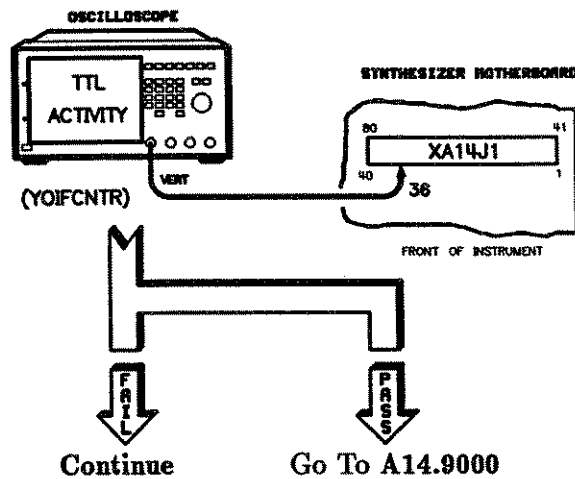

- A5.403** There is an open on the motherboard between XA5J1-25 and XA14J1-36. Verify this with an ohmmeter. Is jumpering the open an acceptable repair?

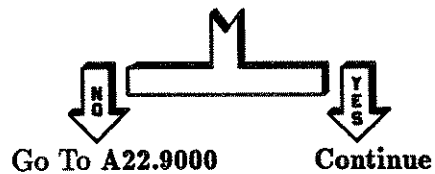

- A5.404** Install a jumper and go to the Troubleshooting Foldout, block 1 (located just prior to the "Special Cases" tab).

A5.410

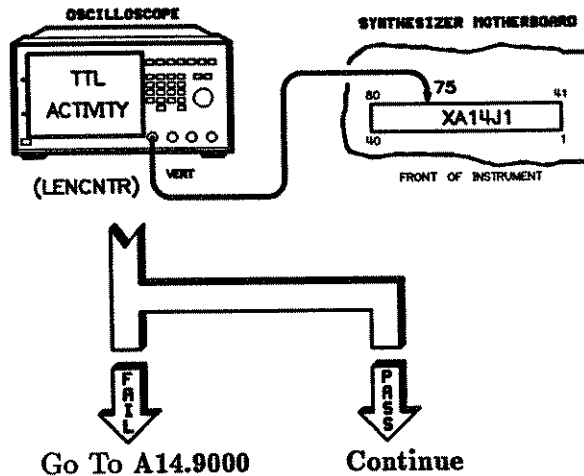

A5.411 There is an open on the motherboard between XA5J1-24 and XA14J1-75. Verify this with an ohmmeter. Is jumpering the open an acceptable repair?

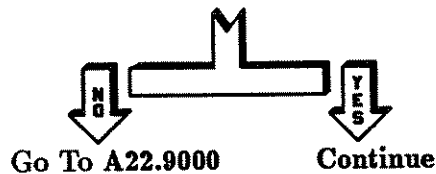

A5.412 Install a jumper and go to the Troubleshooting Foldout, block 1 (located just prior to the "Special Cases" tab).

A5.500 Perform the following key sequence:

1. Press **PRESET** **CW** **SERVICE**.
2. Select **Tools Menu** **Ctrl/PLL** **Frac N Menu** **CW**.
3. To enter a frequency Press **XXXX** **ENTER**.

Where XXX is the frequency of the fractional-N loop.
The frequency of the fractional-N loop is valid from 30 MHz to 60 MHz.

A5.602 There is an open on the motherboard between XA5J1-49 and XA15J1-75. Verify this with an ohmmeter. Is jumpering the open an acceptable repair?

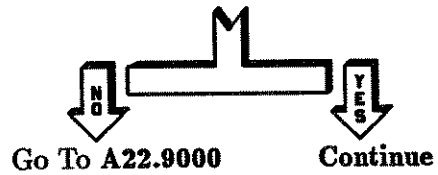

A5.603 Install a jumper. Then go to Troubleshooting Foldout, block 1 (located just prior to the "Special Cases" tab).

A5.8500

Are all five switch positions on A5S1 open?

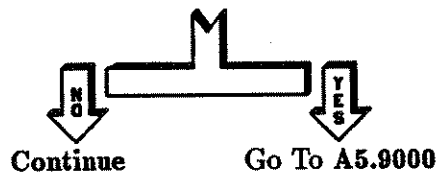
**A5.8501**

Open all five switch positions on A5S1 and rerun self-tests. If the same failure occurs as the original failure, go to A5.9000 and replace A5. If the same failure does not occur, go to the Troubleshooting Foldout, block 1 (located just prior to the "Special Cases" tab.)

A5.9000

Replace the A5 assembly.

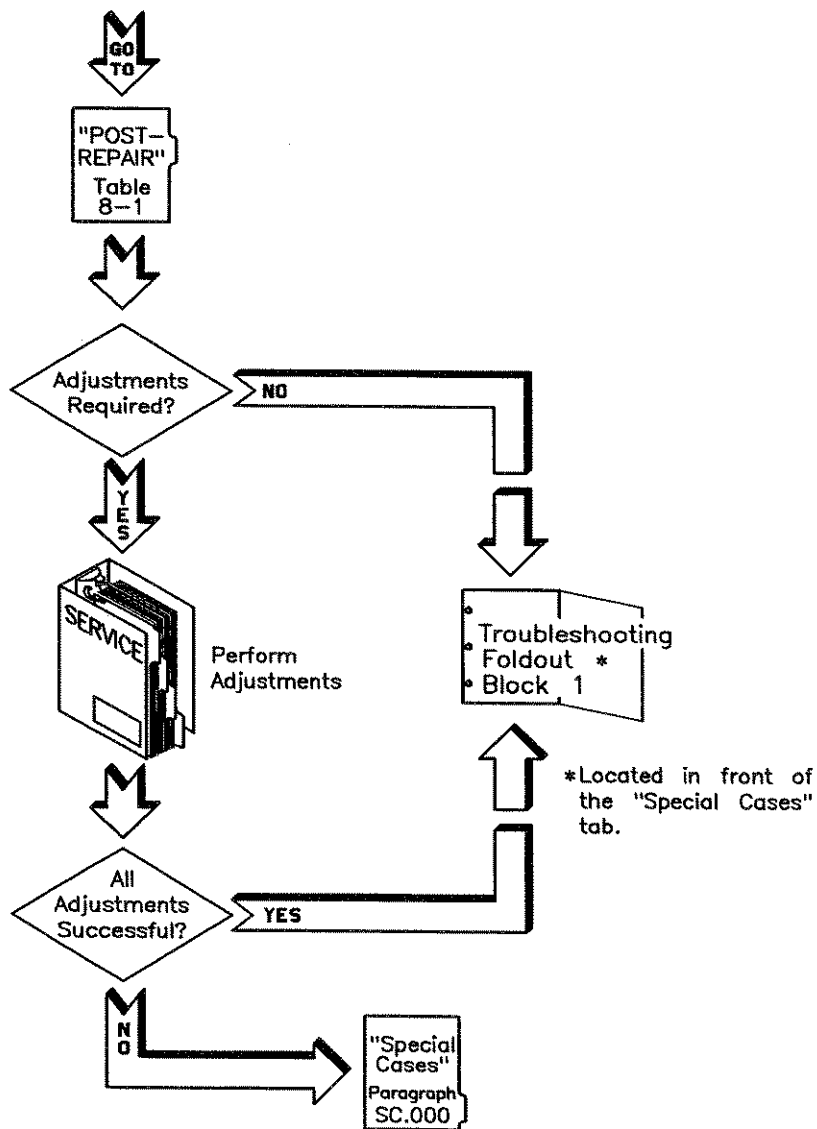

A6 Sampler Troubleshooting

A6.000	Message Displayed on Synthesizer	Go to Paragraph
	A6 : ABUS Ground	A6.100
	A6 : UNLOCK Detector	A6.200
	A6 : Phase Amplifier	A6.300
	A6 : IF Output Level	A6.400
	A6 : VTUNE Endpoints	A6.500
	A6 : Loop Integrator	A6.9000
	A6 : Loop Gain DAC	A6.9000
	A6 : PAL Check	A6.9000
	A6 : IF Amplifier Bias	A6.9000
	A6 : Speed-up Circuit	A6.9000
	A6 : VTUNE Monotonicity	A6.9000
	A6 : Switching Speed	A6.9000

A6.100

Perform the following key sequence:

1. Press **PRESET** **SERVICE**.
2. Select **Selftest Menu**.
3. Press **232** **ENTER**.
4. Select **Loop** (asterisk on).
5. Select **Do Test #232**.

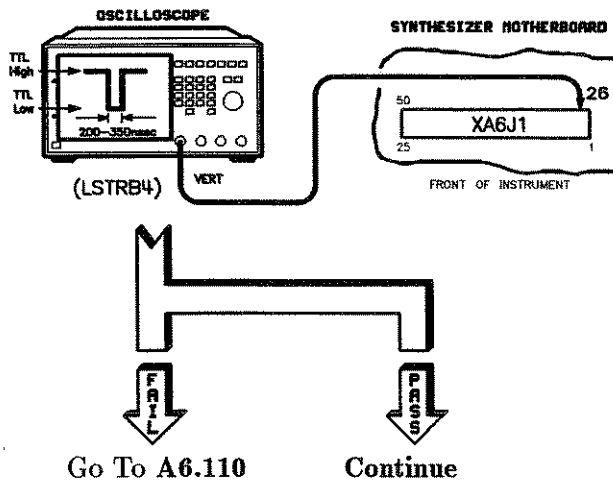

A6.101 Perform the following key sequence:

1. Press **PRESET** **SERVICE**.
2. Select **Selftest Menu**.
3. Press **66** **ENTER**.
4. Select **Loop** (asterisk on).
5. Select **Do Test #66**.

Verify a signal of ≤ 700 mV. However, expect some portions of the signal to rise to levels of up to 15 Vdc. This is not a failure as long as the signal is primarily ≤ 700 mV.

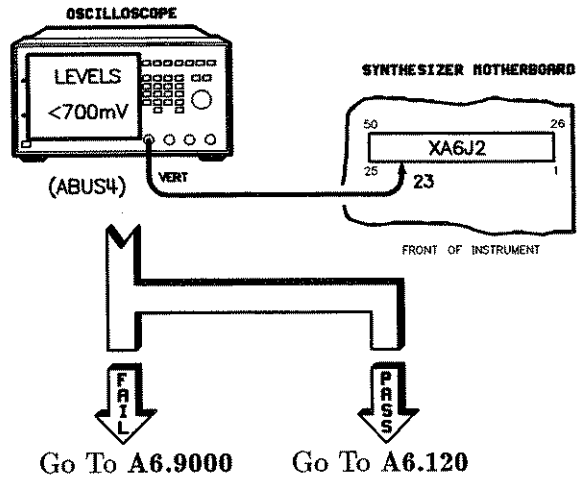

A6.110

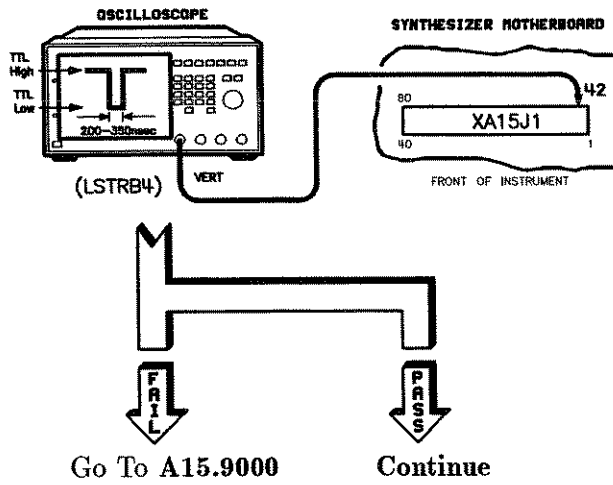

- A6.111** There is an open on the motherboard between XA6J1-26 and XA15J1-42. Verify this with an ohmmeter. Is jumpering the open an acceptable repair?

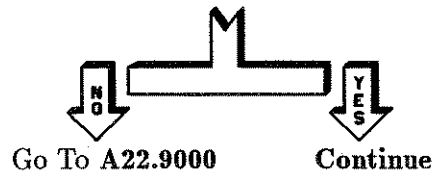

- A6.112** Install a jumper and go to the Troubleshooting Foldout, block 1 (located just prior to the "Special Cases" tab).

- A6.120** Verify a signal of ≤ 700 mV. However, expect some portions of the signal to rise to levels of up to 15 Vdc. This is not a failure as long as the signal is primarily ≤ 700 mV.

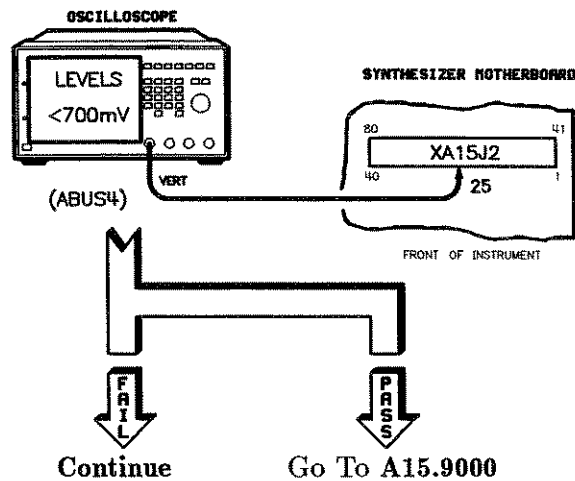

- A6.121** There is an open on the motherboard between XA6J1-23 and XA15J1-25. Verify this with an ohmmeter. Is jumpering the open an acceptable repair?



Go To **A22.9000**

Continue

- A6.122** Install a jumper and go to the Troubleshooting Foldout, block 1 (located just prior to the “Special Cases” tab).

A6.200

Perform the following key sequence:

1. Press **PRESET** **SERVICE**.
2. Select **Selftest Menu**.
3. Press **67** **ENTER**.
4. Select **Loop** (asterisk on).
5. Select **Do Test #67**.

The signal should be dominated by a TTL low. Some TTL highs may be present. A failure is defined as a signal with no TTL lows.

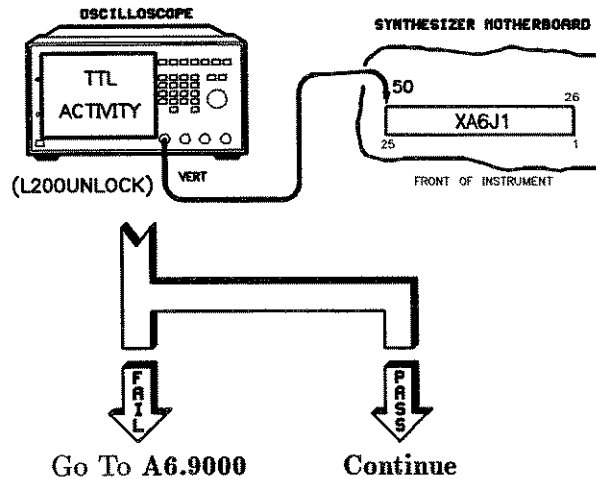

A6.201

The signal should be dominated by a TTL low. Some TTL highs may be present. A failure is defined as a signal with no TTL lows.

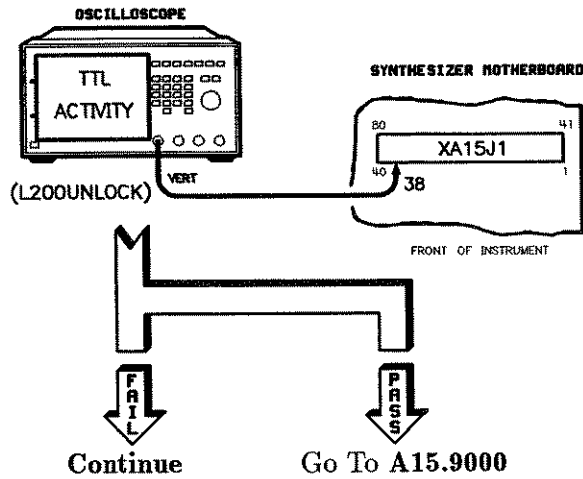

- A6.202** There is an open on the motherboard between XA6J1-50 and XA15J1-38. Verify this with an ohmmeter. Is jumpering the open an acceptable repair?

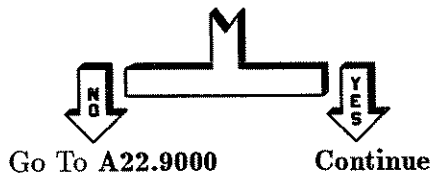

- A6.203** Install a jumper and go to the Troubleshooting Foldout, block 1 (located just prior to the "Special Cases" tab).

A6.300

Set up the oscilloscope for 50Ω input impedance.

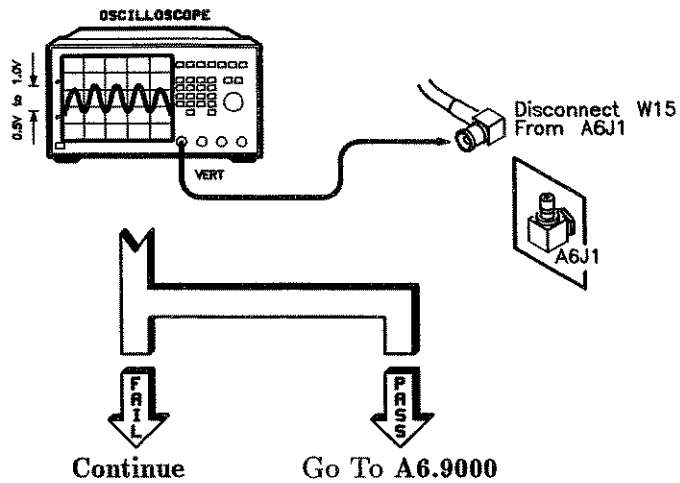

A6.301

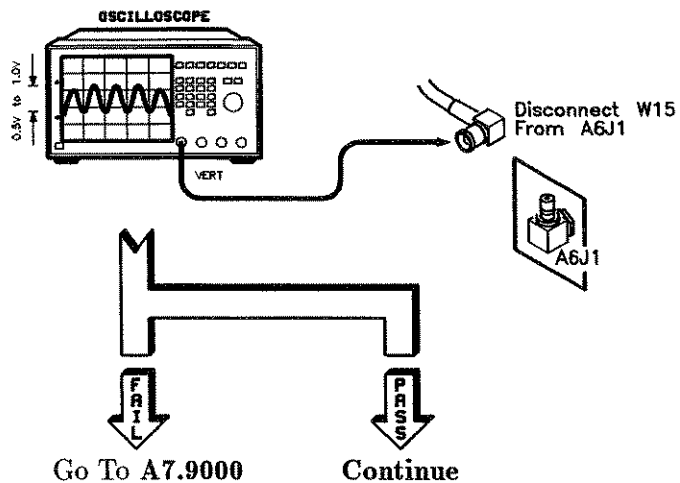

A6.302 Replace W15 and go to the Troubleshooting Foldout, block 1 (located just prior to the “Special Cases” tab).

A6.400

Set up for power measurement:

1. Set the power switch to standby.
2. Remove the top and bottom covers.
3. Turn the synthesizer power on.
4. Press **PRESET** **CW** **SERVICE**.
5. Select **Tools Menu** **Cnt1PLL Menu** **NoPhaseLock** (asterisk on).
6. Select **LoopCnt1 Menu** **Y0 Loop Freq.**
7. Press **2** **GHz**.
8. Using the rotary knob, sweep the frequency from 2.0 to 7.4 GHz and verify that power is greater than -25 dBm.

Set up for frequency measurement:

1. Press **2** **GHz**.
2. Using **▲**, increment the frequency.
3. The measured frequency equals the front panel indication ± 40 MHz (2.0 to 7.4 GHz).

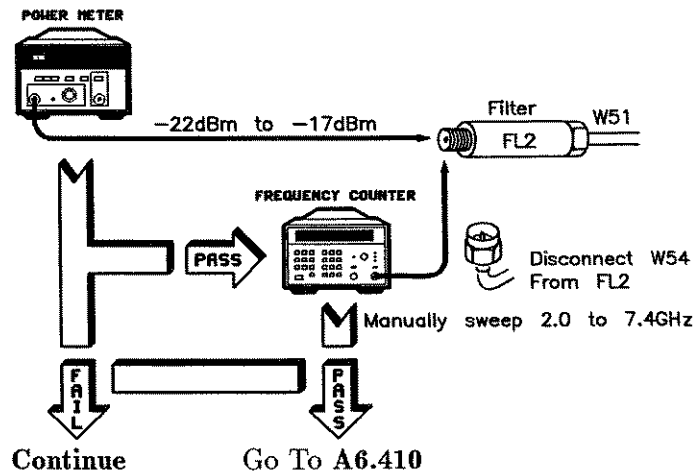

A6.401 Set up for power measurement:

1. Reconnect any disconnected cables.
2. Put the RF deck in the service position.
3. Remove the 20 dB attenuator (AT3) from the directional coupler (A39).
4. Press **PRESET** **CW** **SERVICE**.
5. Select **Tools Menu** **CntlPLL Menu** **NoPhaseLock** (asterisk on).
6. Select **LoopCntl Menu** **Y0 Loop Freq.**
7. Press **2** **GHz**.
8. Using the rotary knob, sweep the frequency from 2 to 7.4 GHz and verify that power is ≥ -7 dBm.

Set up for frequency measurement:

1. Press **2** **GHz**.
2. Using **▲**, increment the frequency.
3. The measured frequency equals the front panel Indication ± 40 MHz (2 to 7.4 GHz).

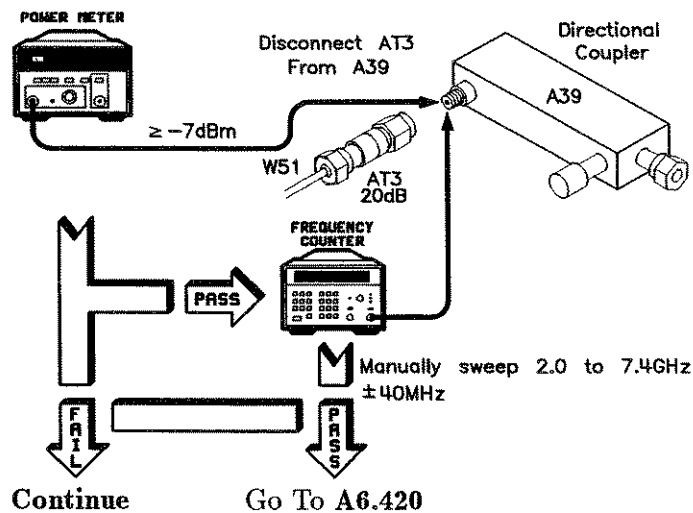

A6.402 Set up for power measurement:

1. Reconnect any disconnected cables.
2. Put the RF deck in the service position.
3. Remove W52 (connects the YIG oscillator, A26, to the directional coupler (A39)).
4. Press **PRESET** **CW** **SERVICE**.
5. Select **Tools Menu** **CntlPLL Menu** **NoPhaseLock** (asterisk on).
6. Select **LoopCntl Menu** **Y0 Loop Freq.**
7. Press **2** **GHz**.
8. Using the rotary knob, sweep the frequency from 2.0 to 7.4 GHz and verify that power is ≥ 11.5 dBm.

Set up for frequency measurement:

1. Press **2** **GHz**.
2. Using **▲**, increment the frequency.
3. The measured frequency equals the front panel indication ± 40 MHz (2.0 to 7.4 GHz).

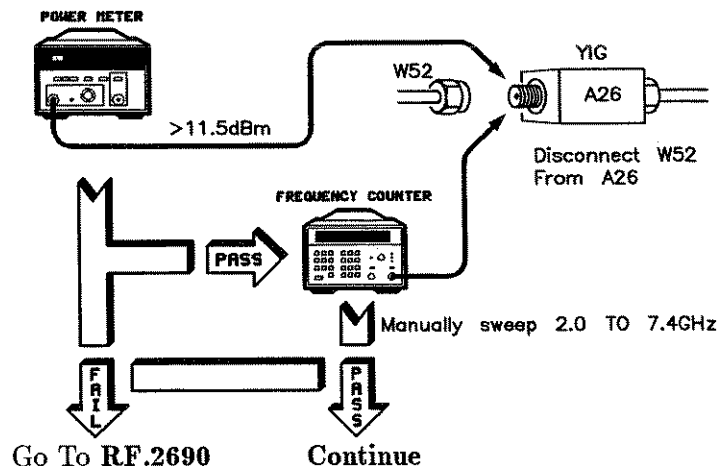

A6.403 Check W52 for damage, deformation, or excessive RF path loss.

Is W52 defective?



Go To **RF.3990**

Continue

Replace W52 and go to the Troubleshooting Foldout, block 1 (located just prior to the "Special Cases" tab).

A6.410 Remove A6 from the synthesizer and disconnect W54 from A6. Inspect and test W54 for defects.

Is W54 defective?



Go To **A6.9000**

Continue

Replace W54 and go to the Troubleshooting Foldout, block 1 (located just prior to the "Special Cases" tab).

A6.420 There is a high-loss path between the directional coupler (A39) and the sampler (A6). This path includes two hard lines (W54, W51), a low pass filter (FL2), and an attenuator (AT3). The most likely failure is a poor connection. Correct the faulty connection or replace the faulty part (W54, FL2, W51, AT3). Isolate and replace the faulty component and go to the Troubleshooting Foldout, block 1 (located just prior to the "Special Cases" tab).

To check for excessive loss in a cable or filter, connect the component input to a known-good signal for the frequency bands in question (see the block diagram

located behind the “Troubleshooting Block Diagrams” tab) and test the output. Over the frequency range of 2.0 to 8.0 GHz, the loss for a coaxial cable should be ≤ 2.0 dB; the loss for a filter should be ≤ 4.0 dB.

A6.500

Refer to the calibration manual. Perform the following adjustments and return.

- A6 VCO Tune.
- A6 Sampler Match.
- A6 Loop Gain.
- A6 IF Gain.

Were you able to perform the adjustments?



Go To **A6.9000**

Continue

A6.501 Perform the following key sequence:

1. Press **PRESET** **SERVICE**.
2. Select **Selftest Menu**.
3. Press **65** **ENTER**.
4. Select **Loop** (asterisk on).
5. Select **Do Test #65**.

Use the rotary knob to review the results of the A6 self-tests. If any A6 self-tests fail, go to A6.9000. Otherwise, go to the Troubleshooting Foldout, block 1 (located just prior to the “Special Cases” tab).

A6.9000

Replace the A6 assembly.

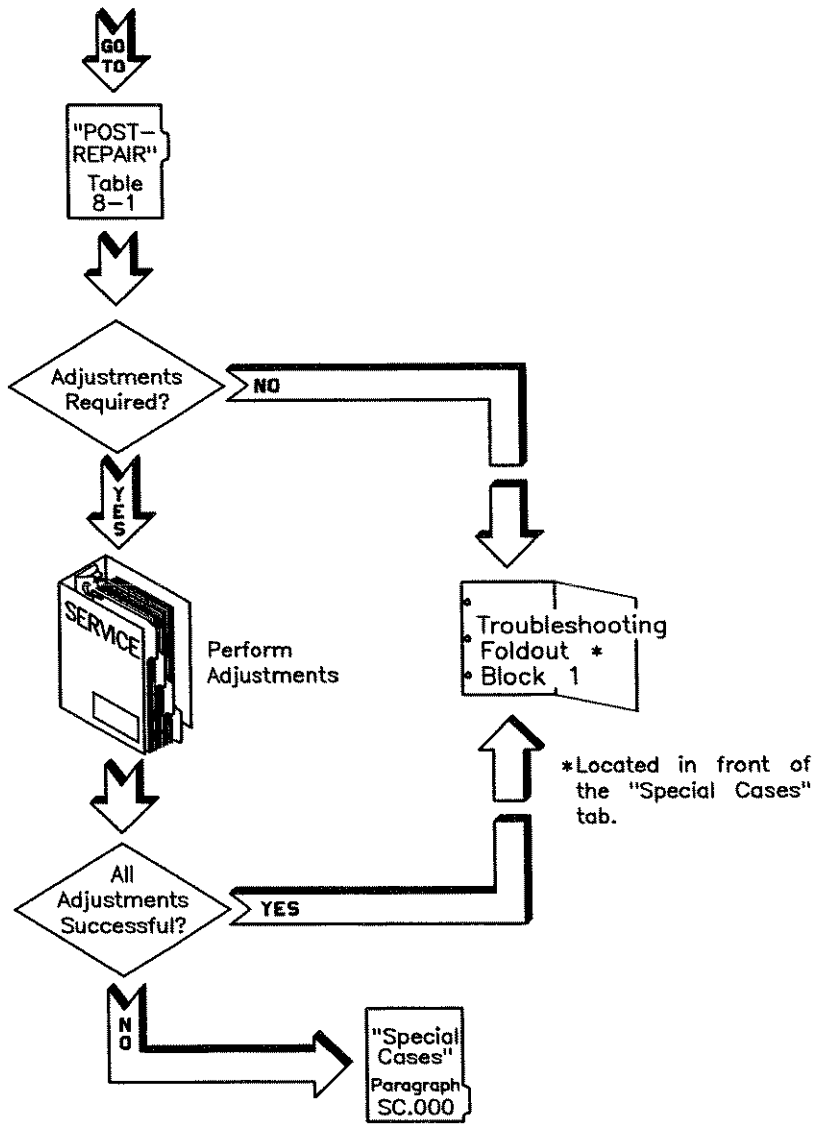

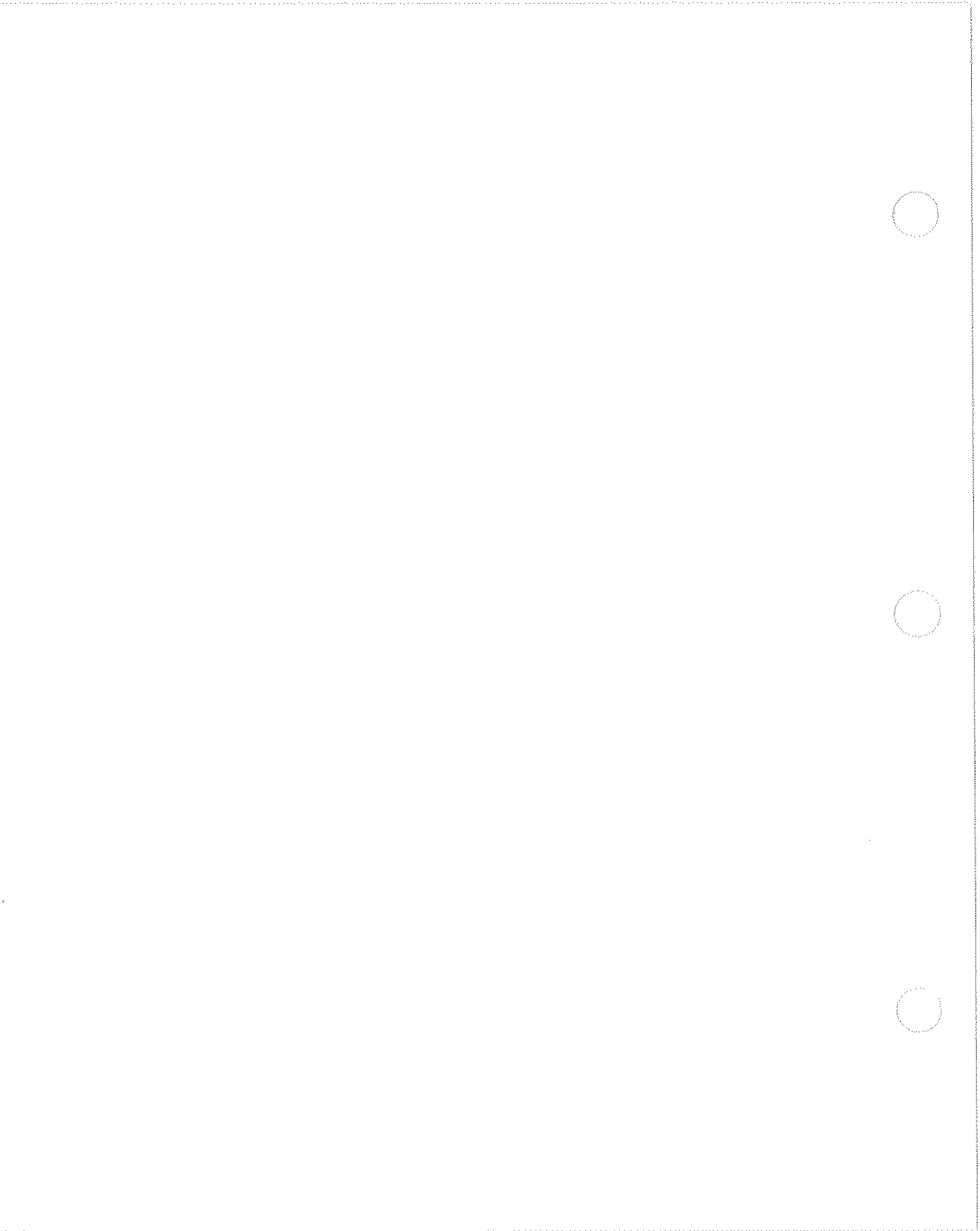

A7 Reference Troubleshooting

A7.000	Message Displayed on Synthesizer	Go to Paragraph
	A7 : ABUS Ground	A7.100
	A7 : -12V Supply	A7.200
	A7 : 10 MHz Standard Input	A7.300
	A7 : UNLOCK Detector	A7.400
	A7 : EXT Reference Switch	A7.500
	A7 : +5V Supply	A7.9000
	A7 : -5V Supply	A7.9000
	A7 : Open Loop VTUNE	A7.9000
	A7 : 40 MHz Output	A7.9000
	A7 : 125 kHz Output	A7.9000
	A7 : INT Reference Switch	A7.9000

A7.100

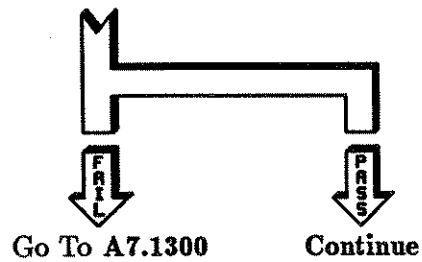
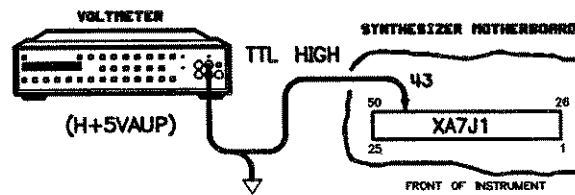

A7.101 Loop self-test #231:

1. Press **PRESET** **SERVICE**.
2. Select **Selftest Menu**.
3. Press **231** **ENTER**.
4. Select **Loop Do Test #231**.

A7.102

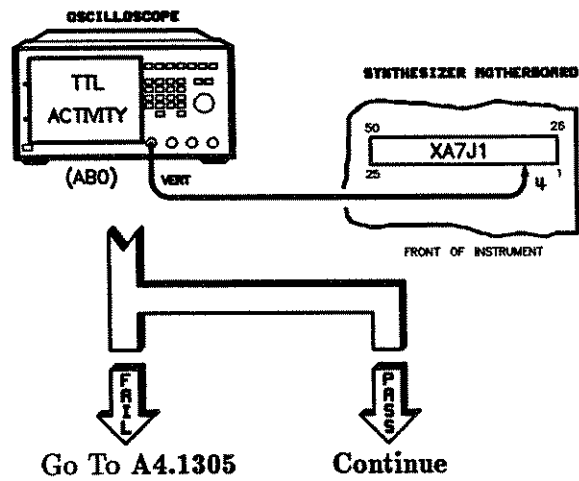

A7.103

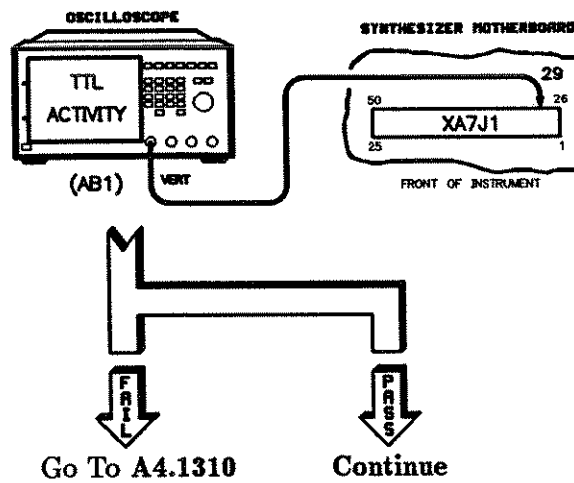

A7.104

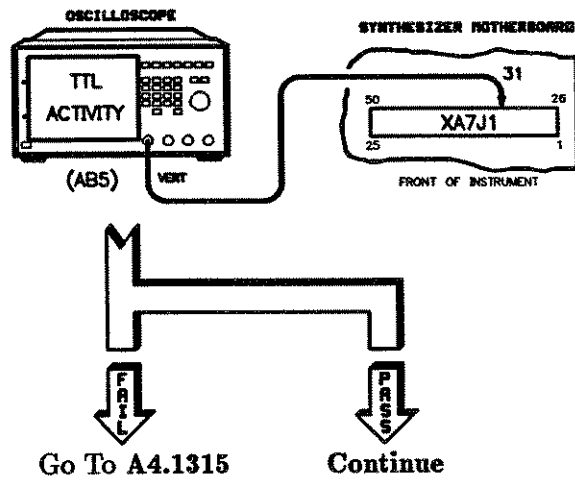

A7.105

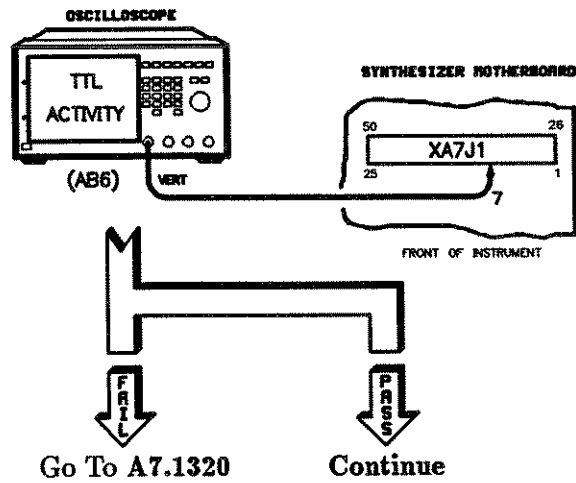

A7.106 Loop self-test #232:

1. Press **PRESET** **SERVICE**.
2. Select **Selftest Menu**.
3. Press **232** **ENTER**.
4. Select **Loop Do Test #232**.

A7.107

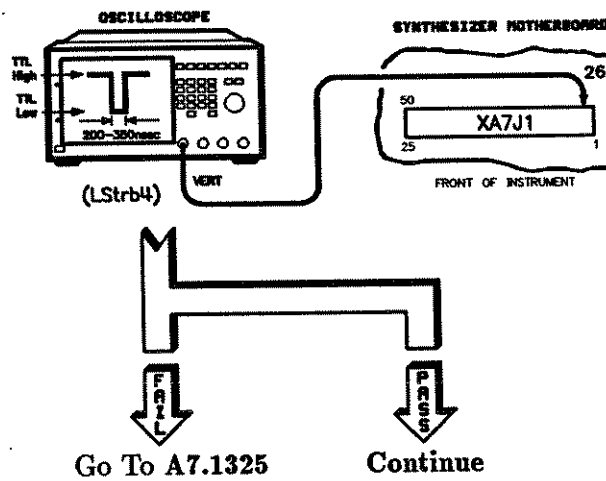

A7.302

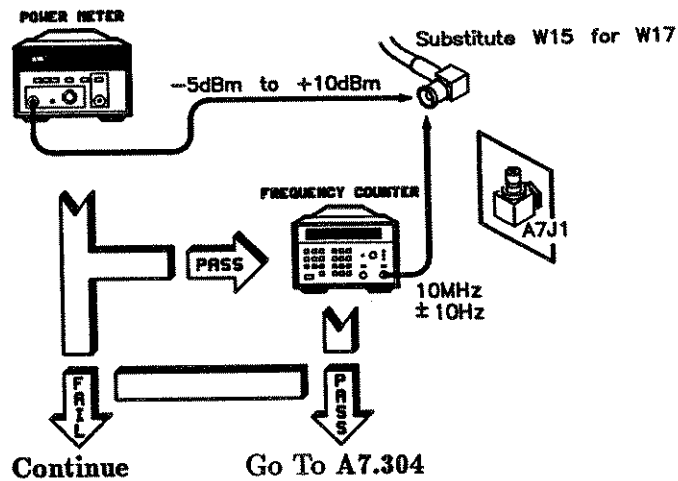

A7.303 Go to A23.000 (troubleshoot the 10 MHz reference).

A7.304 Replace W17 and go to the Troubleshooting Foldout, block 1 (located just prior to the "Special Cases" tab).

A7.400

Loop self-test #94:

1. Press **PRESET** **SERVICE**.
2. Select **Selftest Menu**.
3. Press **94** **ENTER**.
4. Select **Loop Do Test #94**.

A7.401 Check for a TTL signal with a period of *1.5 to 3.0 seconds*.

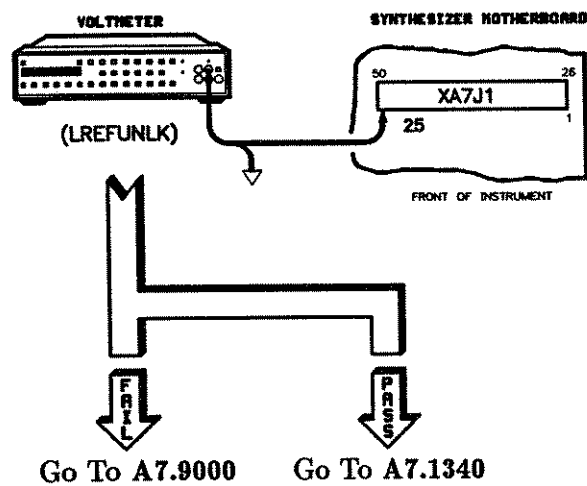

A7.500

Are you using an external standard?

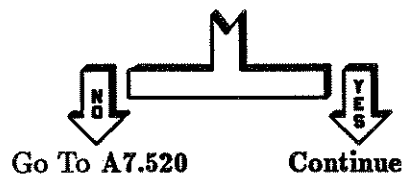

A7.501

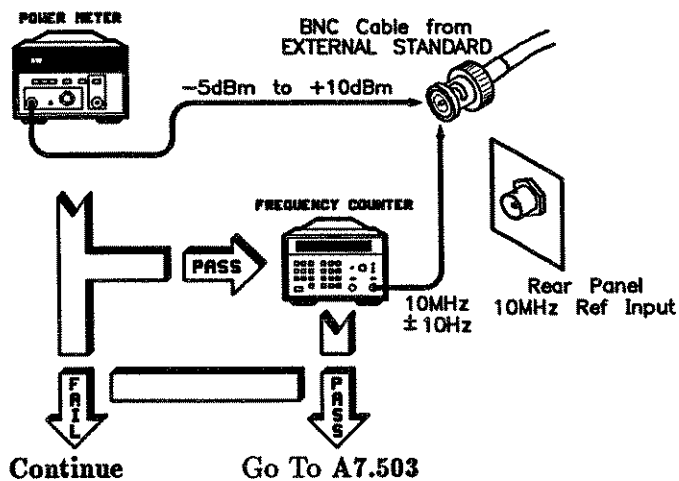

A7.502 The external standard is faulty. Correct the external reference (see instrument specifications) and go to the Troubleshooting Foldout, block 1 (located just prior to the "Special Cases" tab).

A7.503

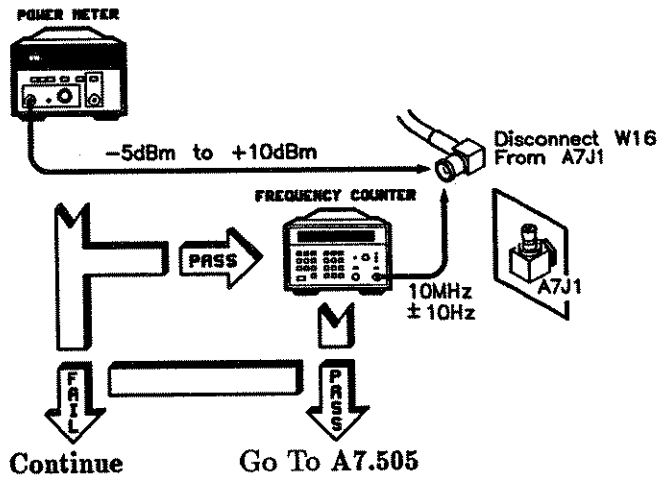

A7.504 Replace W16 and go to the Troubleshooting Foldout, block 1 (located just prior to the "Special Cases" tab).

A7.505

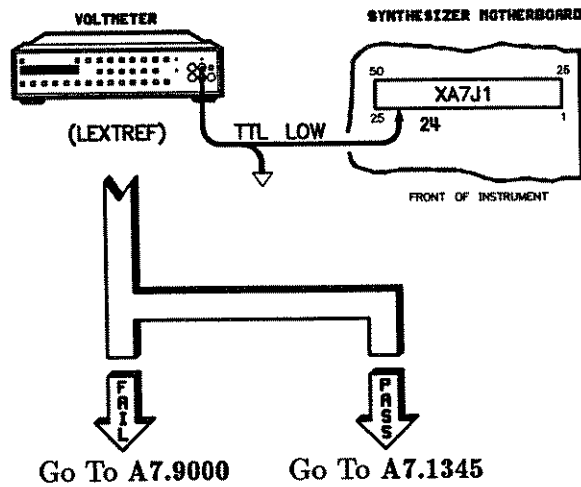

A7.520

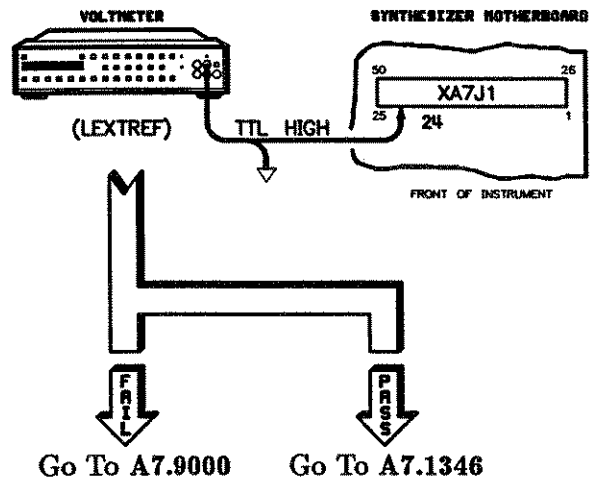

A7.1300

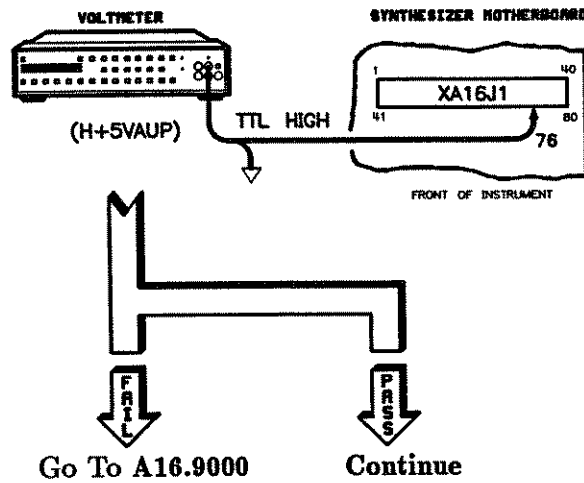

- A7.1301** There is an open on the motherboard between XA7J1-43 and XA16J1-76. Verify this with an ohmmeter. Is jumpering an acceptable repair?

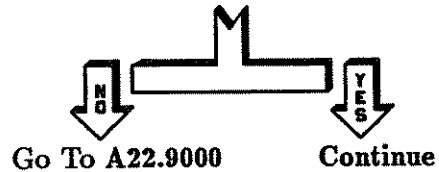

- A7.1302** Install a jumper and go to the Troubleshooting Foldout, block 1 (located just prior to the "Special Cases" tab).

A7.1305

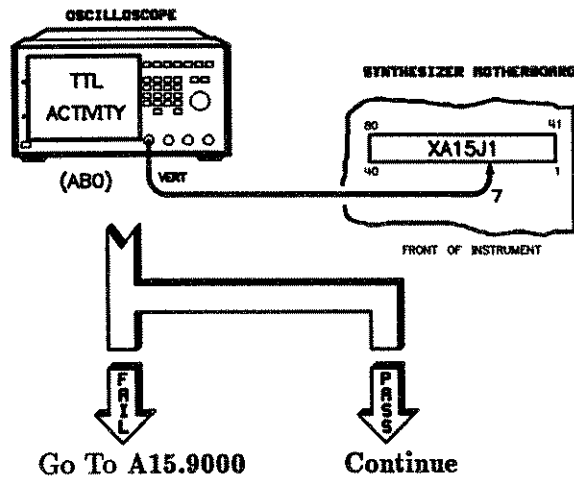

A7.1306 There is an open on the motherboard between XA7J1-4 and XA15J1-7. Verify this with an ohmmeter. Is jumpering an acceptable repair?

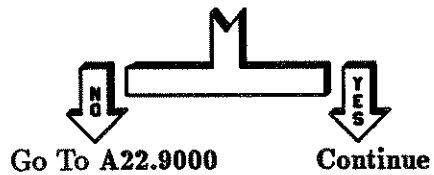

A7.1307 Install a jumper and go to the Troubleshooting Foldout, block 1 (located just prior to the "Special Cases" tab).

A7.1310

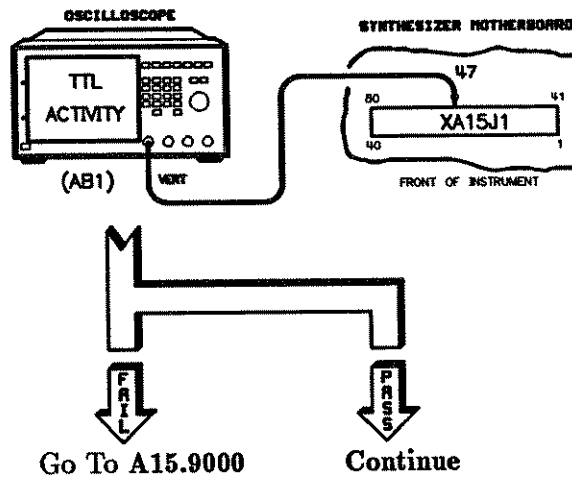

A7.1311 There is an open on the motherboard between XA7J1-29 and XA15J1-47. Verify this with an ohmmeter. Is jumpering an acceptable repair?

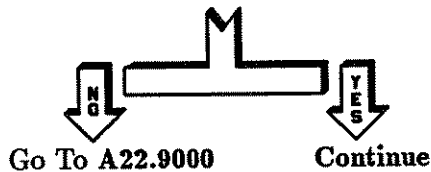

A7.1312 Install a jumper and go to the Troubleshooting Foldout, block 1 (located just prior to the "Special Cases" tab).

A7.1315

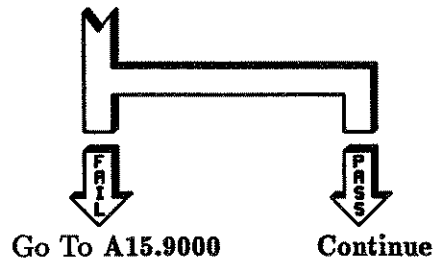
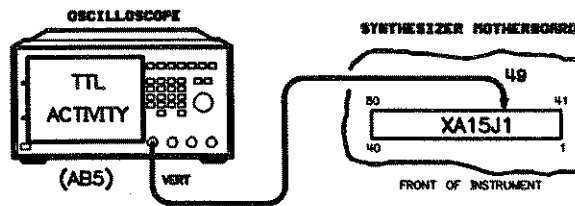

A7.1316 There is an open on the motherboard between XA7J1-31 and XA15J1-49. Verify this with an ohmmeter. Is jumpering an acceptable repair?

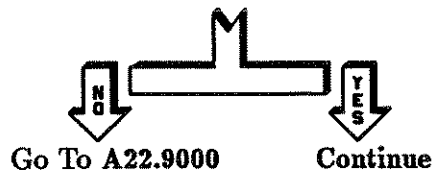

A7.1317 Install a jumper and go to the Troubleshooting Foldout, block 1 (located just prior to the "Special Cases" tab).

A7.1320

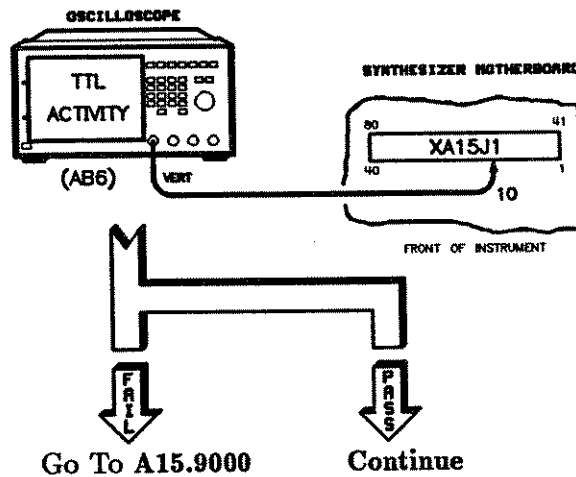

- A7.1321** There is an open on the motherboard between XA7J1-7 and XA15J1-10. Verify this with an ohmmeter. Is jumpering an acceptable repair?

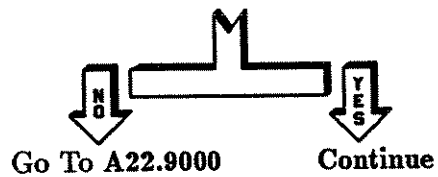

- A7.1323** Install a jumper and go to the Troubleshooting Foldout, block 1 (located just prior to the "Special Cases" tab).

- A7.1335** There is an open on the motherboard between XA7J2-22 and XA15J2-24. Verify this with an ohmmeter. Is jumpering an acceptable repair?

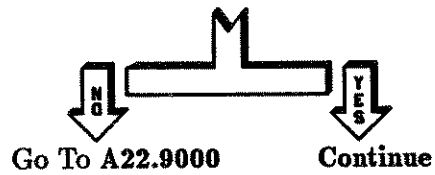

- A7.1336** Install a jumper and go to the Troubleshooting Foldout, block 1 (located just prior to the "Special Cases" tab).

- A7.1340** Check for a TTL signal with a period of 1.5 to 3.0 seconds.

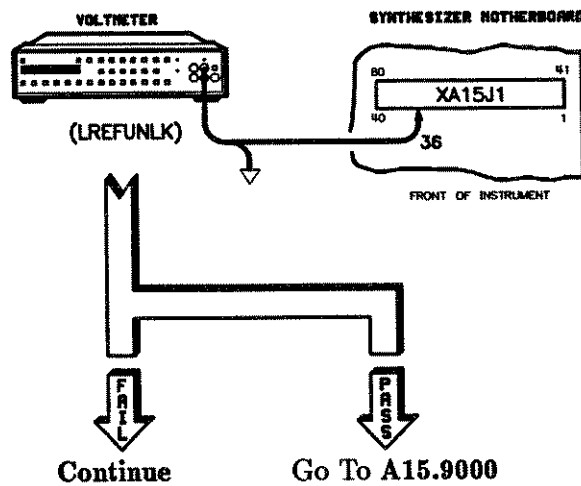

A7.1341 There is an open on the motherboard between XA7J1-25 and XA15J1-36. Verify this with an ohmmeter. Is jumpering an acceptable repair?

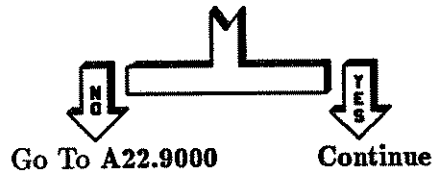

A7.1342 Install a jumper and go to the Troubleshooting Foldout, block 1 (located just prior to the "Special Cases" tab).

A7.1345

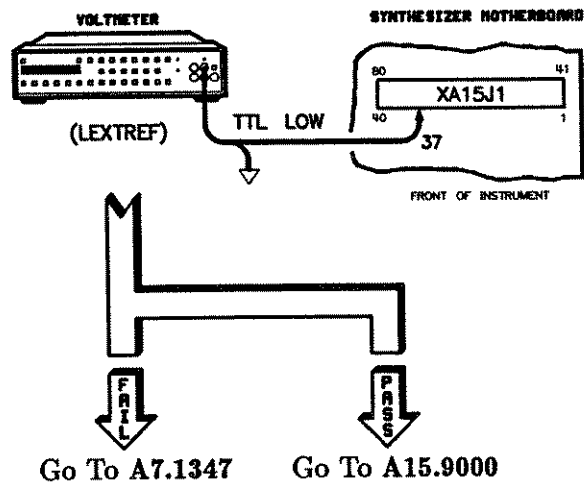

A7.1346

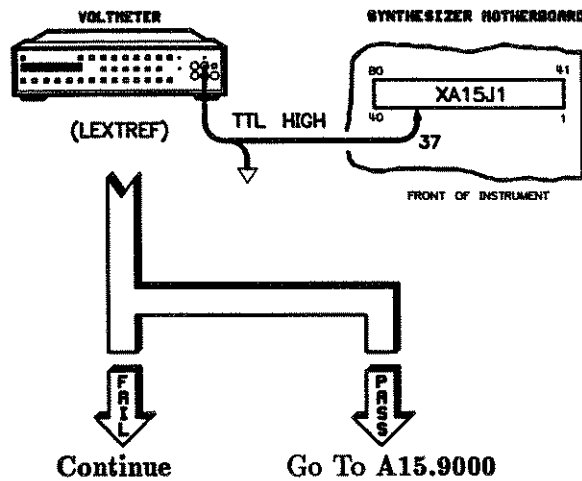

A7.1347 There is an open on the motherboard between XA7J1-24 and XA15J1-37. Verify this with an ohmmeter. Is jumpering an acceptable repair?

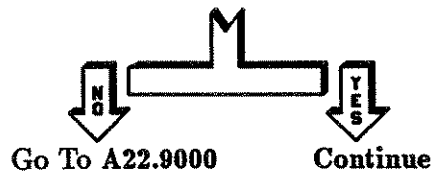

A7.1348 Install a jumper and go to the Troubleshooting Foldout, block 1 (located just prior to the "Special Cases" tab).

A7.9000

Replace the A7 assembly.

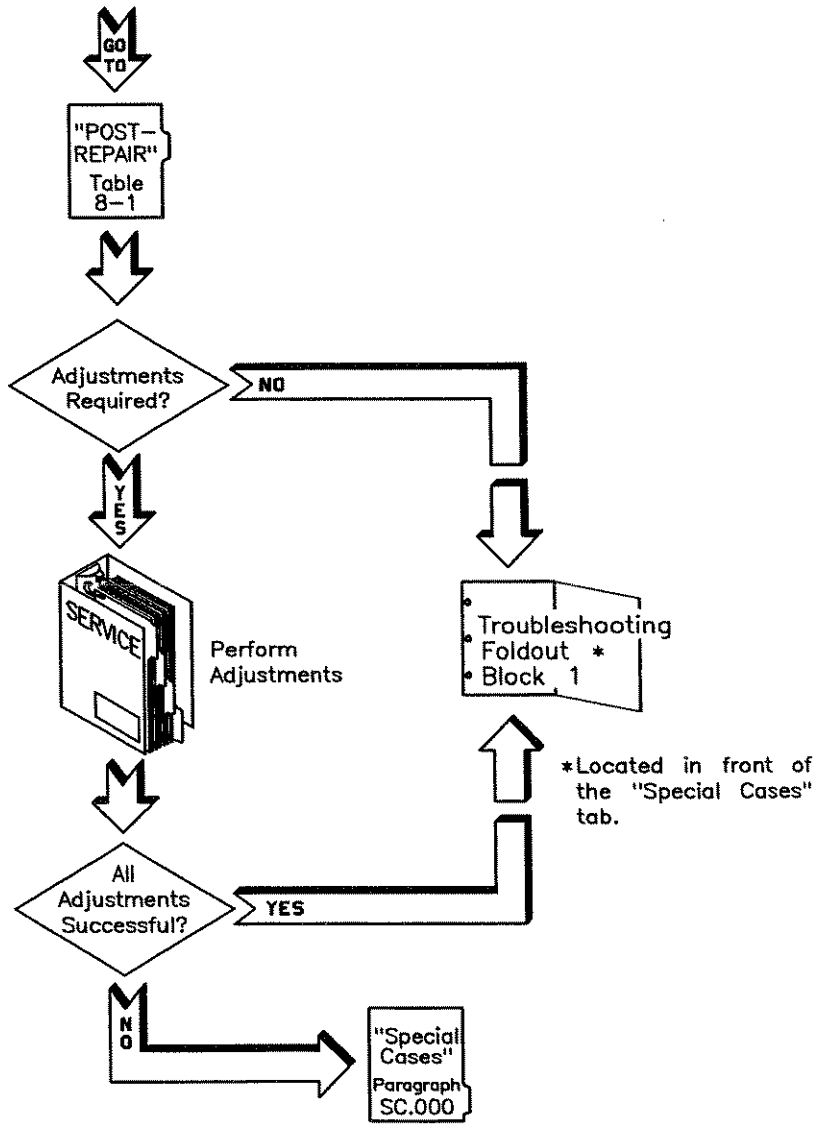

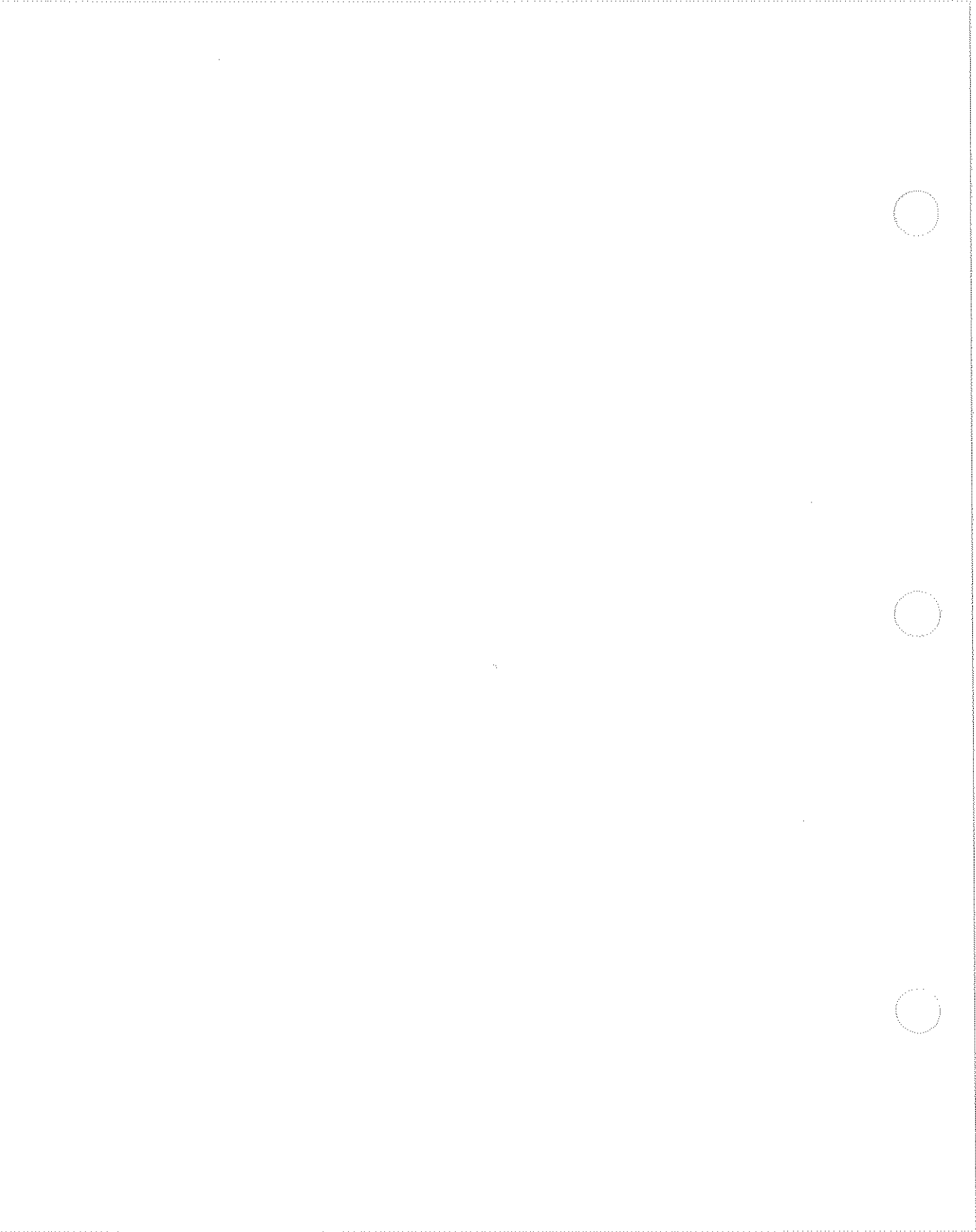

A9 Pulse Troubleshooting

A9.000	Message Displayed on Synthesizer	Go to Paragraph
	A9 : Self Bias	A9.100
	A9 : Squegging Clamp	A9.200
	A9 : Modulator Selection	A9.300
	A9 : Integrate/Hold Switch	A9.400
	A9 : Slow Pulse Drive	A9.9000

A9.100

Perform the following key sequence:

1. Press **PRESET**.
2. **START** **2** **GHz**.
3. **STOP** **7** **GHz**.

Ensure when viewing the waveform that the input to the oscilloscope is DC coupled. An AC coupled input may distort the waveform.

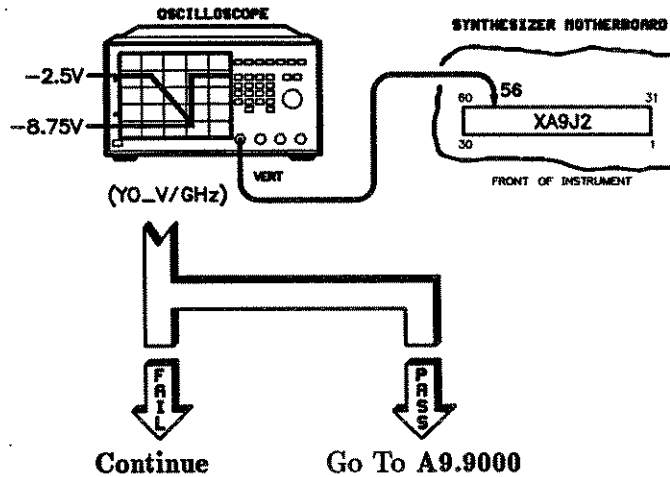

A9.101

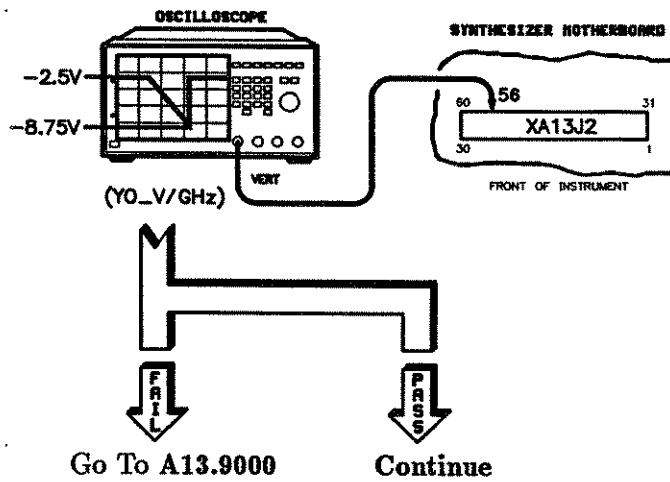

A9.102 There is an open on the motherboard between XA9J2-56 and XA13J2-56. Verify this with an ohmmeter. Is jumpering the open an acceptable repair?

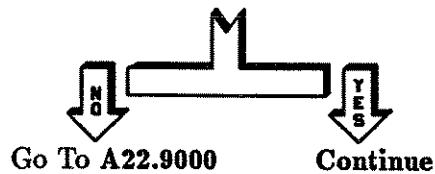

A9.103 Install a jumper and go to the Troubleshooting Foldout, block 1 (located just prior to the "Special Cases" tab).

A9.221

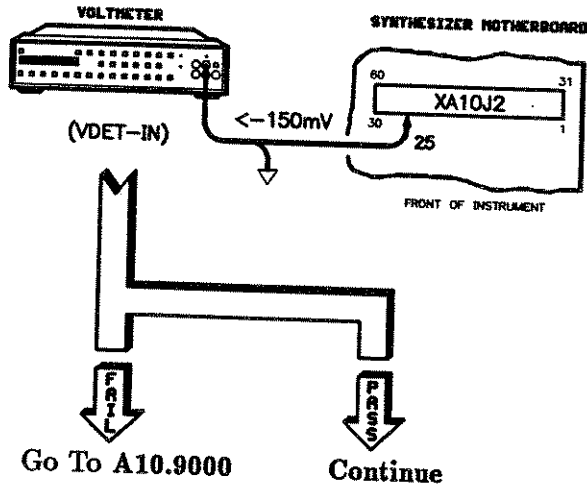

A9.222 There is an open on the motherboard between XA9J2-55 and XA10J2-25. Verify this with an ohmmeter. Is jumpering an acceptable repair?

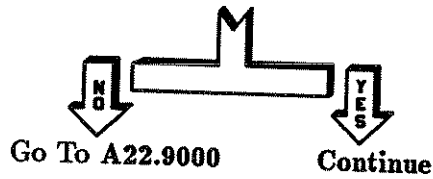

A9.223 Install a jumper and go to the Troubleshooting Foldout, block 1 (located just prior to the "Special Cases" tab).

A9.202 There is an open on the motherboard between XA9J1-25 and XA10J1-25. Verify this with an ohmmeter. Is jumpering the open an acceptable repair?

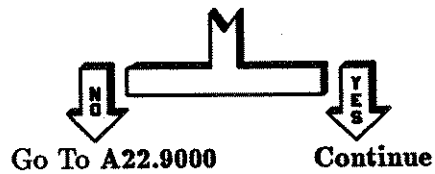

A9.203 Install a jumper and go to the Troubleshooting Foldout, block 1 (located just prior to the "Special Cases" tab).

A9.220 Press **PRESET** **CW**.

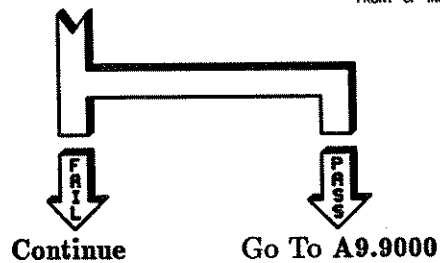
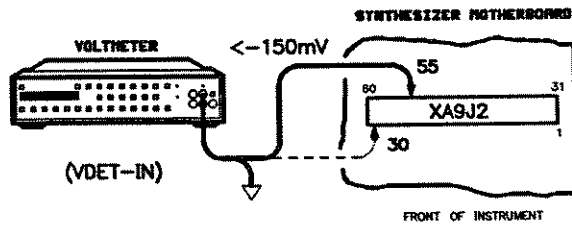

A9.221

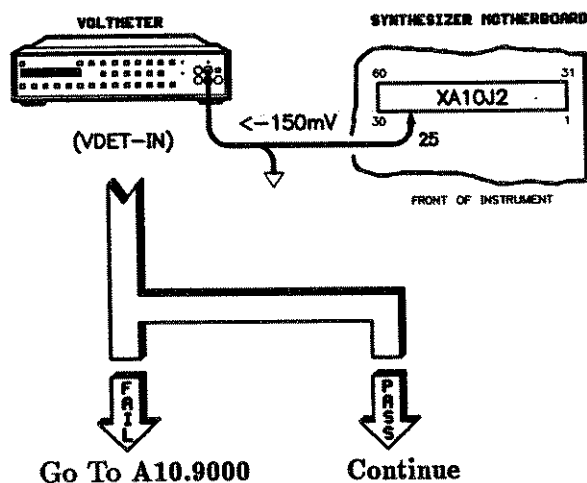

- A9.222** There is an open on the motherboard between XA9J2-55 and XA10J2-25. Verify this with an ohmmeter. Is jumpering an acceptable repair?

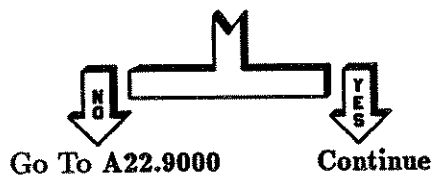

- A9.223** Install a jumper and go to the Troubleshooting Foldout, block 1 (located just prior to the "Special Cases" tab).

A9.300

Perform the following key sequence:

1. Press **PRESET** **SERVICE**.
2. Select **Selftest Menu**.
3. Press **108** **ENTER**.
4. Select **Loop** (asterisk on).
5. Select **Do Test #108**.

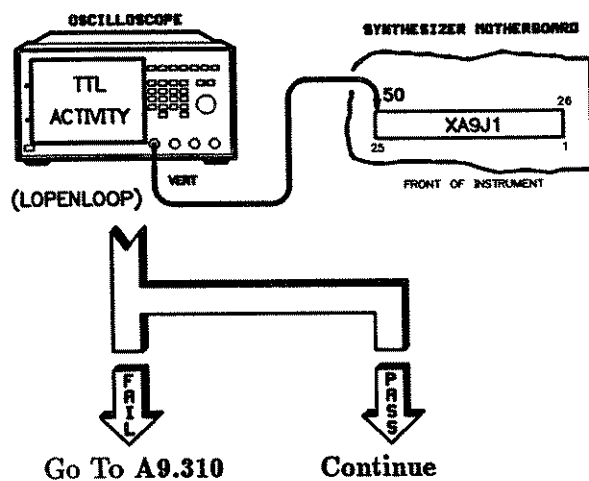

A9.301

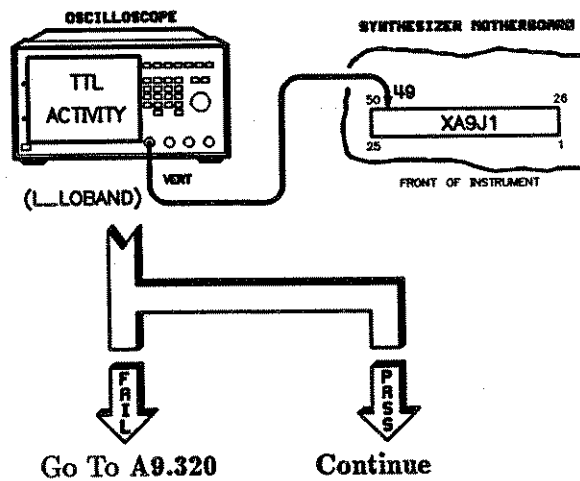

A9.302 Do the following:

1. Select Loop (asterisk off).
2. Disconnect W32 from A22J3 and disconnect W33 from A22J4. (These cables are located between the RF deck and the card cage.)
3. Select Do Test #108.

Did self-test #108 pass?

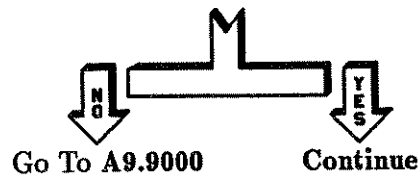

A9.303 Do the following:

1. Reconnect W32 to A22J3.
2. Select **Do Test #108**.

Did self-test #108 pass?



A9.304 Do the following:

1. Disconnect W32 from A25J3.
2. Select **Do Test #108**.

Did self-test #108 pass?



A9.305 Replace W32 and go to the Troubleshooting Foldout, block 1 (located just prior to the "Special Cases" tab).

A9.306 Do the following:

1. Reconnect W33 to A22J4.
2. Disconnect W33 from A24J6.
3. Select **Do Test #108**.

Did self-test #108 pass?

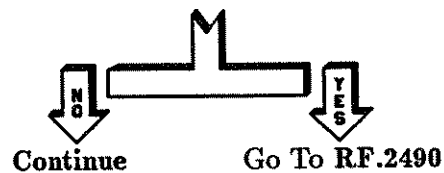

A9.307 Replace W33 and go to the Troubleshooting Foldout, block 1 (located just prior to the "Special Cases" tab).

A9.310

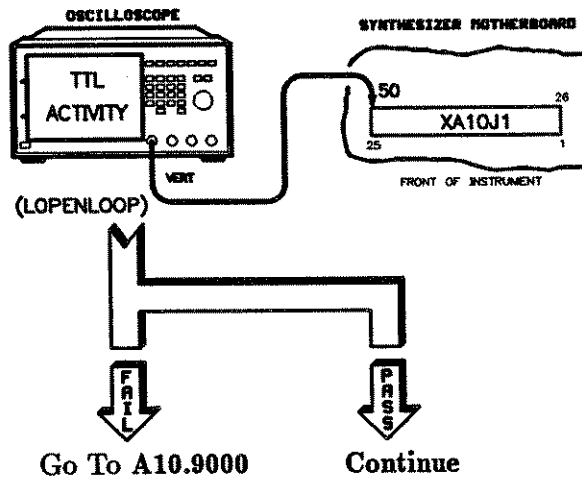

A9.311 There is an open on the motherboard between XA9J1-50 and XA10J1-50. Verify this with an ohmmeter. Is jumpering the open an acceptable repair?

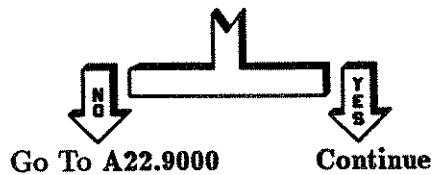

A9.312 Install a jumper and go to the Troubleshooting Foldout, block 1 (located just prior to the "Special Cases" tab).

A9.320

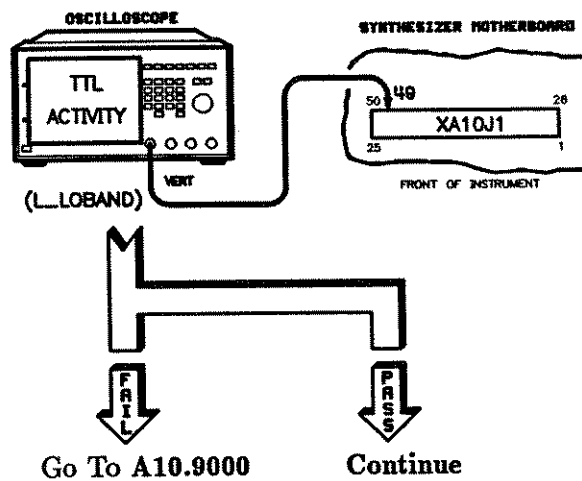

A9.321 There is an open on the motherboard between XA9J1-49 and XA10J1-49. Verify this with an ohmmeter. Is jumpering the open an acceptable repair?

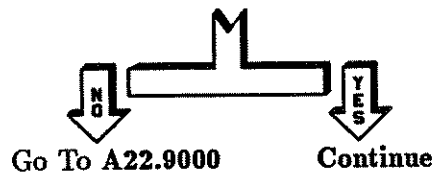

A9.322 Install a jumper and go to the Troubleshooting Foldout, block 1 (located just prior to the "Special Cases" tab).

A9.400

Perform the following key sequence:

1. Press **PRESET** **SERVICE**.
2. Select **Selftest Menu**.
3. Press **105** **ENTER**.
4. Select **Loop** (asterisk on).
5. Select **Output Menu** **When to Log Always** (asterisk on).
6. Press **PRIOR**.
7. Select **Do Test #105**.

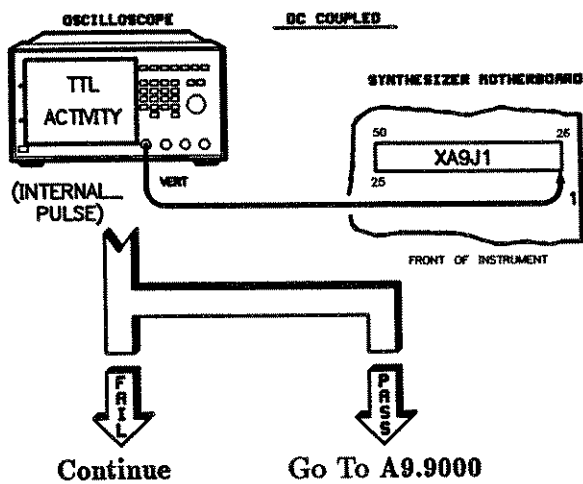

A9.401

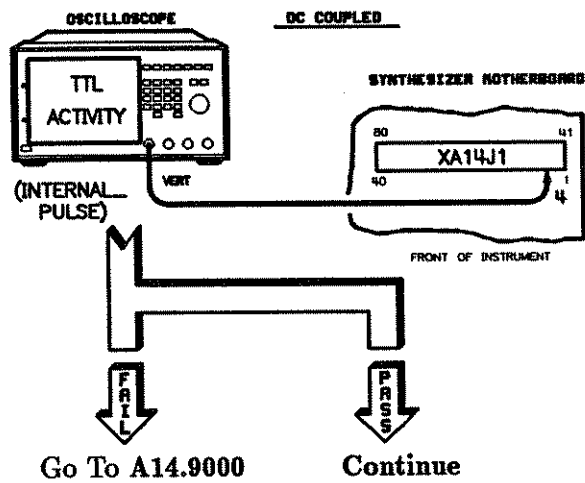

- A9.402** There is an open on the motherboard between XA9J1-1 and XA14J1-4. Verify this with an ohmmeter. Is jumpering the open an acceptable repair?

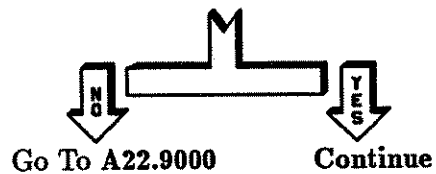

- A9.403** Install a jumper and go to the Troubleshooting Foldout, block 1 (located just prior to the "Special Cases" tab).

A9.9000

Replace the A9 assembly.

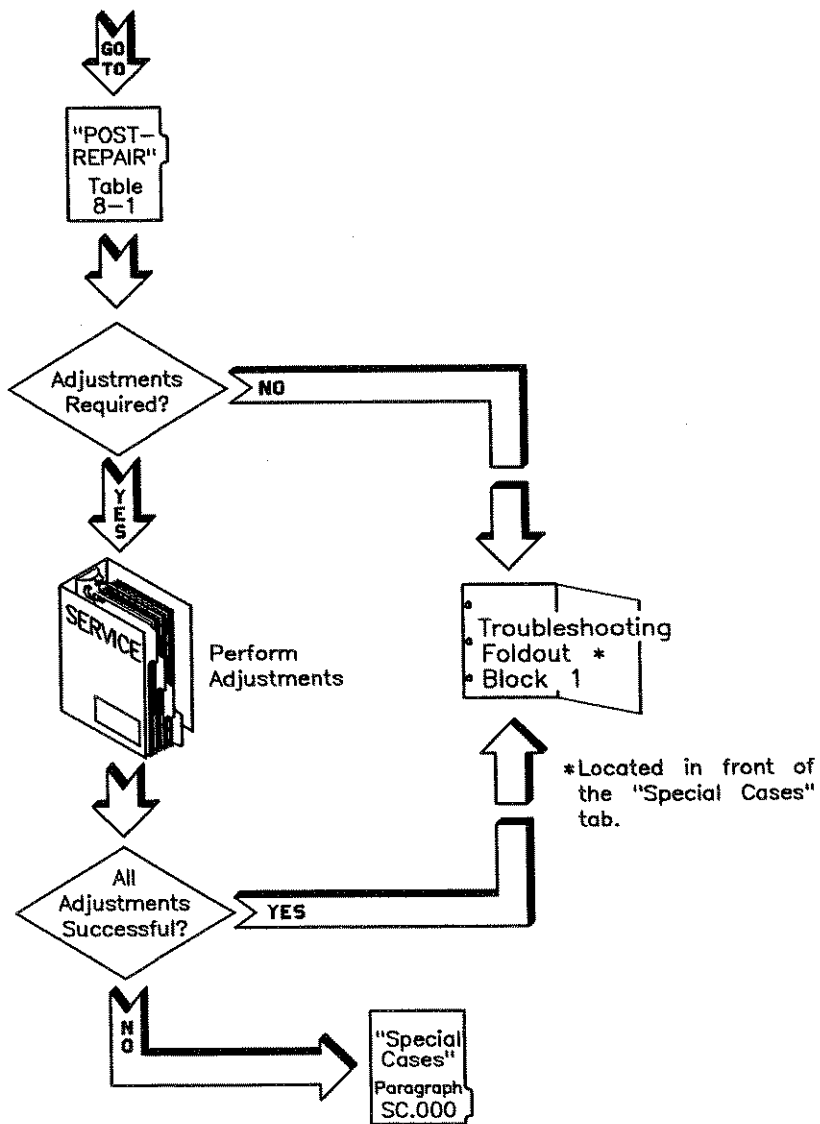

A10 ALC Troubleshooting

A10.000	Message Displayed on Synthesizer	Go to Paragraph
	A10 : -10VF Supply	A10.100
	A10 : Meter Log Amplifier	A10.200
	A10 : ALC Reference	A10.300
	A10 : Detector Log Amplifier	A10.400
	A10 : Source Module Intfc	A10.500
	A10 : Unleveled Detectors	A10.600
	A10 : Modulator Drive Lo Bnd	A10.700
	A10 : Modulator Drive Hi Bnd	A10.700
	A10 : Loop Integrator	A10.800
	A10 : T.C. Ref Supply	A10.9000
	A10 : Detector Offset DAC	A10.9000
	A10 : Detector x10 Amplifier	A10.9000
	A10 : AM Logger Offset	A10.9000

A10.200

Are there any cables connected to the rear/front panel ALC input?

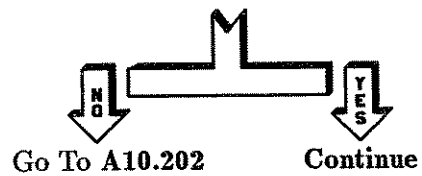

A10.201

Perform the following setup:

1. Remove all connections to the external ALC input.
2. Press **PRESET** **SERVICE**.
3. Select **Selftest Menu**.
4. Press **124** **ENTER**.
5. Select **Do Test #124**.

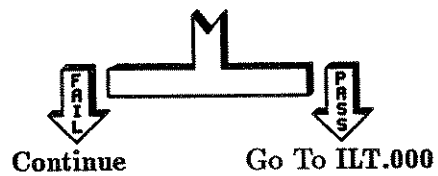

A10.102 There is an open on the motherboard between XA10J2-21 and XA13J2-21. Verify this with an ohmmeter. Is jumpering the open an acceptable repair?

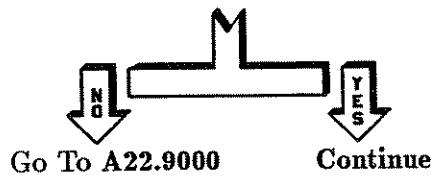

A10.103 Install a jumper. Then go to the Troubleshooting Foldout, block 1 (located just prior to the “Special Cases” tab).

A10.200

Are there any cables connected to the rear/front panel ALC input?

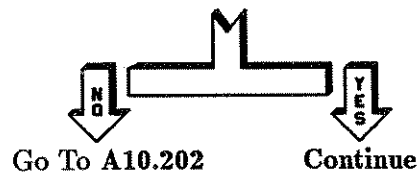

A10.201

Perform the following setup:

1. Remove all connections to the external ALC input.
2. Press **PRESET** **SERVICE**.
3. Select **Selftest Menu**.
4. Press **124** **ENTER**.
5. Select **Do Test #124**.

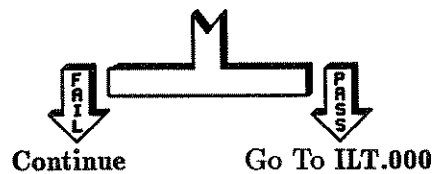

A10.202 Press **PRESET** **CW**.

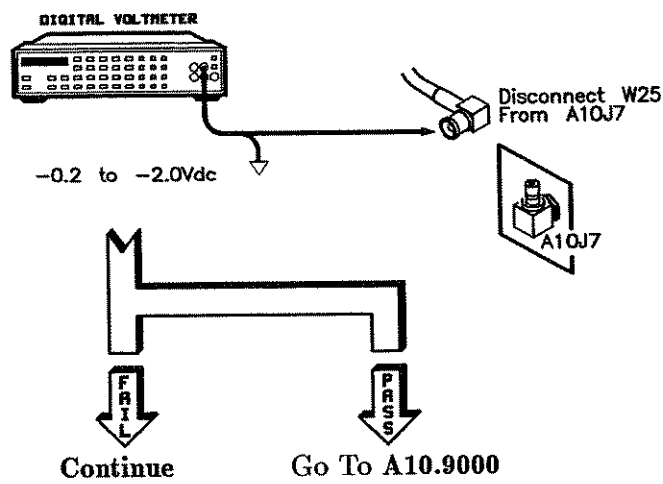

A10.203 Perform the following setup:

1. Press **PRESET** **CW** **5** **GHz**.
2. Press **POWER LEVEL** **10** **dBm**.

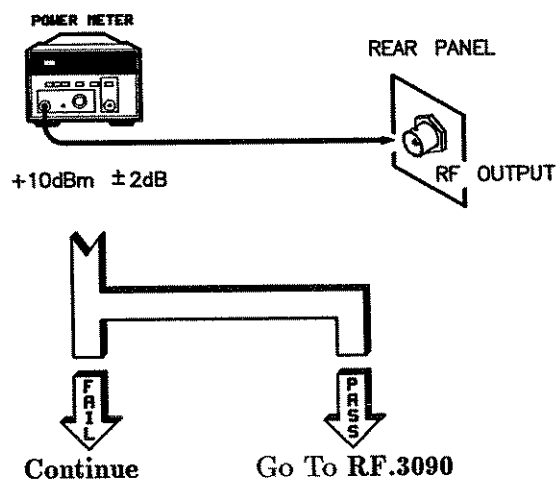

A10.204 There is an RF output problem. This failure made the A10 diagnostics fail. Before we can go further this RF problem must be isolated.

Go to ILT.2240.

A10.300

Perform the following setup:

1. Press **PRESET** **SERVICE**.
2. Select **Selftest Menu**.
3. Press **128** **ENTER**.
4. Select **Log** (asterisk on).
5. Select **Output Menu** **When to Log Always** (asterisk on).
6. Press **PRIOR**.
7. Select **Do Test #128**.
8. The voltage at XA10J2-4 should be $-4.5V \pm 1.5V$.
9. Select **Cont.**
10. The voltage at XA10J2-4 should be $-0.0V \pm 1.5V$.
11. Select **Cont.**
12. The voltage at XA10J2-4 should be $-9.0V \pm 1.5V$.
13. Select **Cont.**

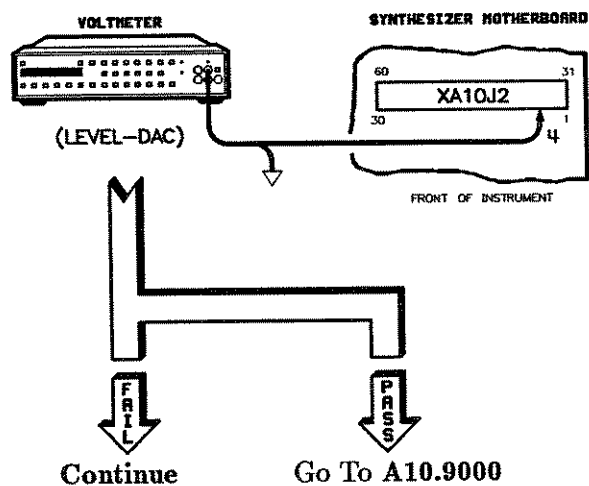

A10.301 Perform the following setup:

1. Press **PRESET** **SERVICE**.
2. Select **Selftest Menu**.
3. Press **128** **ENTER**.
4. Select **Log** (asterisk on).
5. Select **Output Menu** **When to Log Always** (asterisk on).
6. Press **PRIOR**.
7. Select **Do Test #128**.
8. The voltage at XA14J2-1 should be $-4.5V \pm 1.5V$.
9. Select **Cont.**
10. The voltage at XA14J2-1 should be $-0.0V \pm 1.5V$.
11. Select **Cont.**
12. The voltage at XA14J2-1 should be $-9.0V \pm 1.5V$.
13. Select **Cont.**

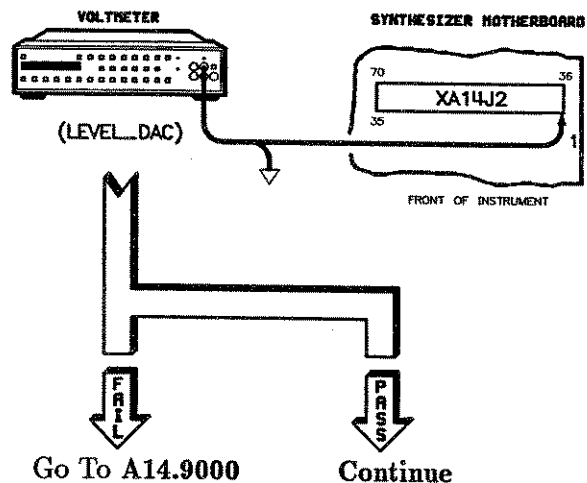

A10.302 There is an open on the motherboard between XA10J2-4 and XA14J2-1. Verify this with an ohmmeter. Is jumpering the open an acceptable repair?

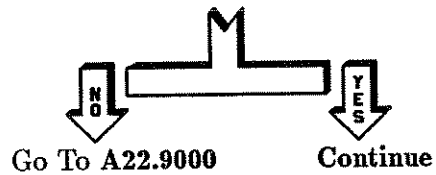

A10.303 Install a jumper. Then go to the Troubleshooting Foldout, block 1 (located just prior to the "Special Cases" tab).

A10.400

Perform the following setup:

1. Press **PRESET** **SERVICE**.
2. Select **Selftest Menu**.
3. Press **126** **ENTER**.
4. Select **Loop Do Test #126**.

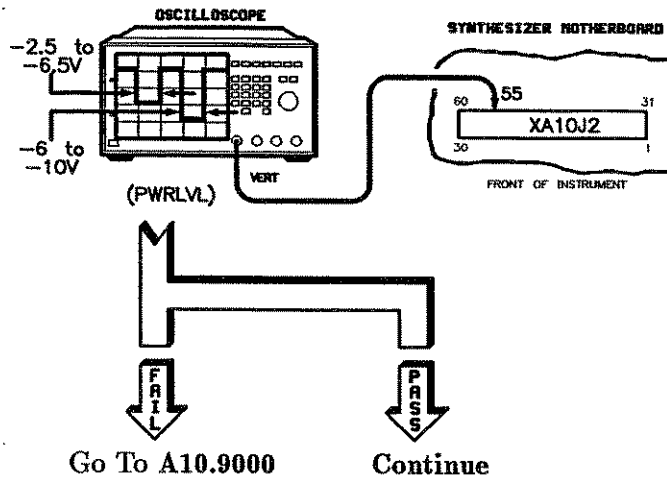

A10.401

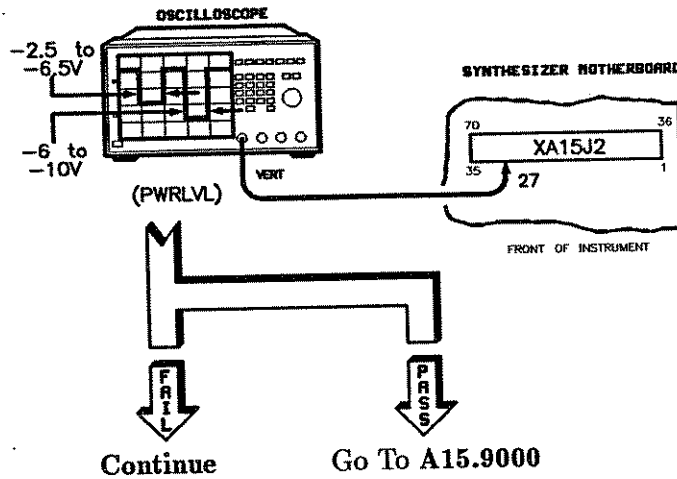

A10.402

There is an open on the motherboard between XA10J2-55 and XA15J2-27. Verify this with an ohmmeter. Is jumpering the open an acceptable repair?

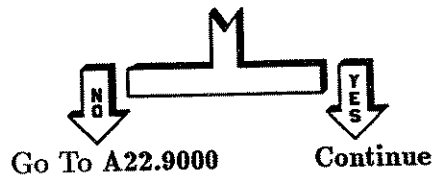

A10.403

Install a jumper. Then go to the Troubleshooting Foldout, block 1 (located just prior to the "Special Cases" tab).

A10.500

Are there any cables connected to the rear/front panel SMI (source module interface) connectors?

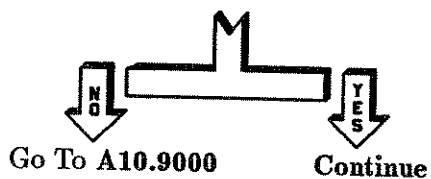

A10.501

Perform the following setup:

1. Remove all connections to the SMI inputs.
2. Press **PRESET** **SERVICE**.
3. Select **Selftest Menu**.
4. Press **127** **ENTER**.
5. Select **Do Test #127**.

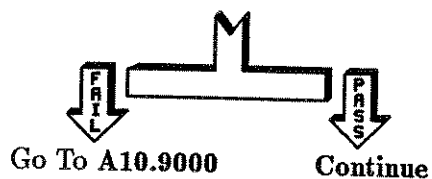

A10.502

The problem appears to be partially solved. Remove any remaining connections and go to the Troubleshooting Foldout, block 1 (located just prior to the "Special Cases" tab).

A10.600

Perform the following setup:

1. Press **PRESET** **SERVICE**.
2. Select **Selftest Menu**.
3. Press **131** **ENTER**.
4. Select **Loop** (asterisk on).
5. Select **Do Test #131**.

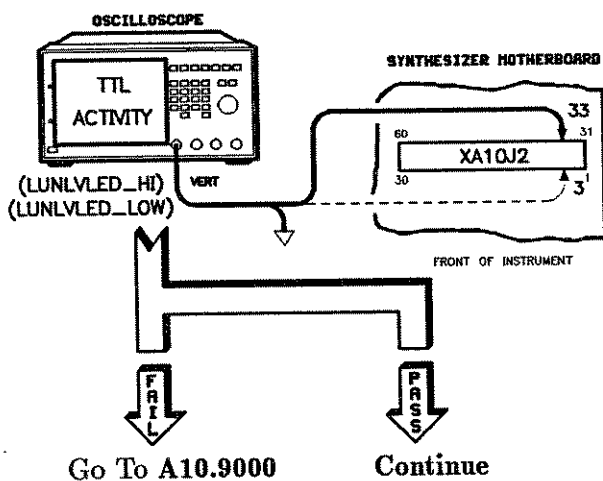

A10.601

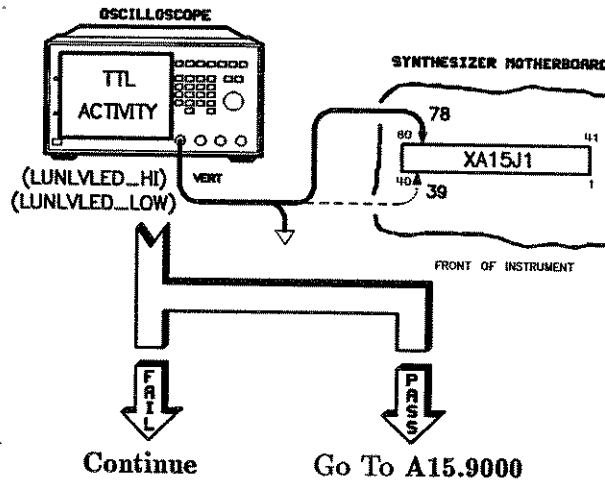

A10.602 There is an open on the motherboard between XA10J2-3 and XA15J1-39, or there is an open between XA10J2-33 and XA15J1-78 (note that these lines are two separate signals). Verify this with an ohmmeter.

Is jumpering the open an acceptable repair?

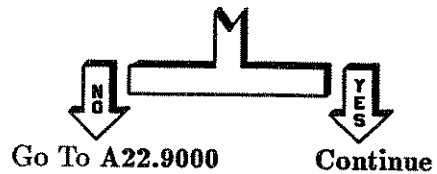

A10.603 Install a jumper. Then go to the Troubleshooting Foldout, block 1 (located just prior to the "Special Cases" tab).

A10.700

Perform the following setup:

1. Press **PRESET** **SERVICE**.
2. Select **Selftest Menu**.
3. Press **132** **ENTER**.
4. Note the pass/fail condition of test 132.
5. Press **133** **ENTER**.
6. Note the pass/fail condition of test 133.

Did both test #132 and test #133 fail?

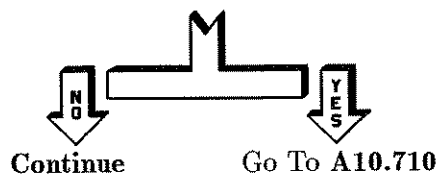

A10.701 Did only test #132 fail?



A10.702 The most likely cause of this failure is either W34 (A22J6 to A25J2) or A10. However, before replacing A10, check all cables (especially W34) and wiring harnesses around A10 and the RF deck. If you find any problems, correct them and then go to the Troubleshooting Foldout, block 1 (located just prior to the "Special Cases" tab).

If you do not find any problems, replace A10 (go to A10.9000) if it has not already been replaced. Otherwise, replace the AM modulator A38 (go to RF.3890.)

A10.705 The most likely cause of this failure is either W35 (A22J5 to A24J7) or A10. However, before replacing A10, check all cables (especially W35) and wiring harnesses around A10 and the RF deck. Note that W35 does not slip on to A24J7, it screws on. If you find any problems, correct them and then go to the Troubleshooting Foldout, block 1 (located just prior to the "Special Cases" tab).

If you do not find any problems, replace A10 (go to A10.9000) if it has not already been replaced. Otherwise, replace the A24 (go to RF.2490.)

A10.710 The problem is almost certainly A10. However, before replacing A10, check all cabling and wiring harnesses around A10 and the RF deck. If you find any problems, correct them and then go to the Troubleshooting Foldout, block 1 (located just prior to the "Special Cases" tab).

If you do not find any problems, replace A10 (go to A10.9000) if it has not already be replaced. If A10 has been replaced, go to A10.702, A10.705, and "Special Cases" for additional information.

A10.800

Are *all* cables removed from the synthesizer including any connections to EXT ALC?

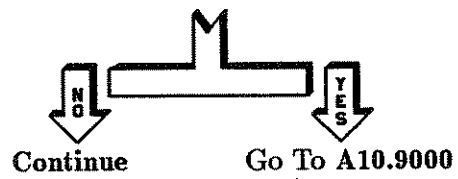

A10.801 Remove *all* cables and go to ILT.105.

A 10.9000

Replace the A10 assembly.

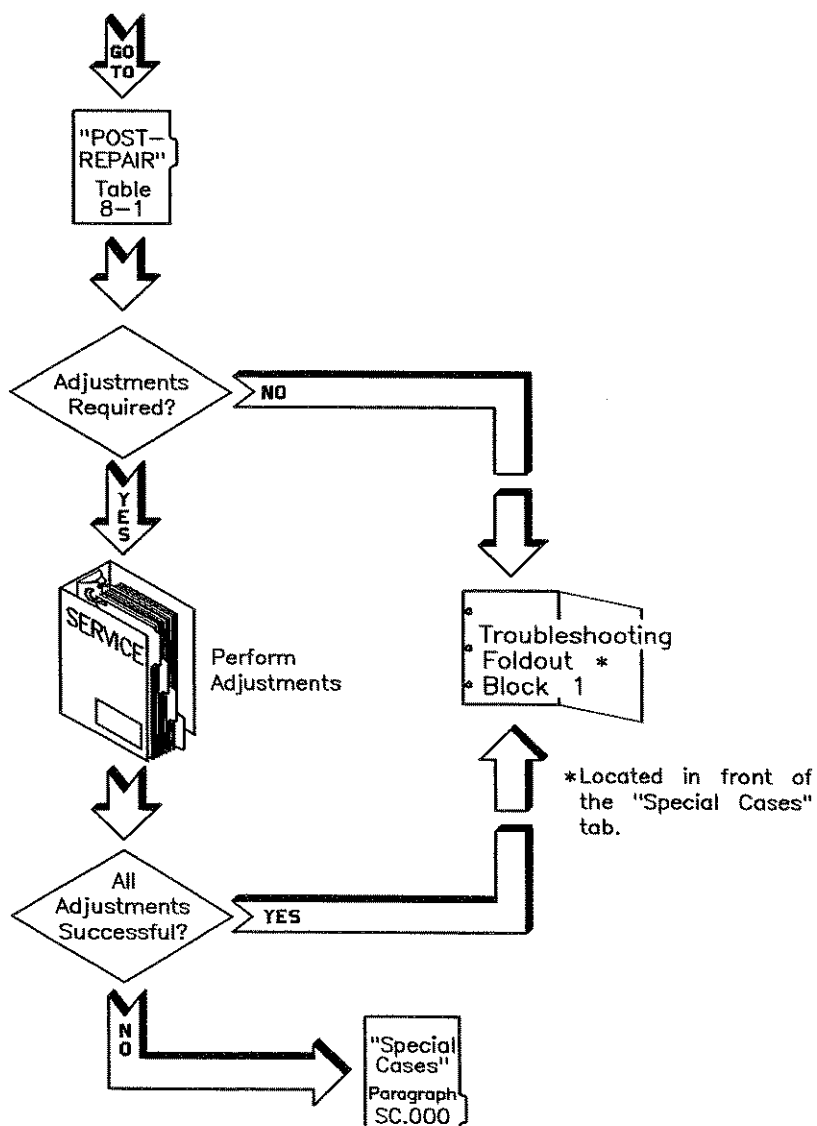

A11.101 Perform the following key sequence:

1. Press **PRESET** **SERVICE**.
2. Select **Selftest Menu**.
3. Press **142** **ENTER**.
4. Select **Loop** (asterisk on).
5. Select **Do Test #142**.

Verify a signal of ≤ 700 mV. However, expect some portions of the signal to rise to levels of up to 15 Vdc. This is not a failure as long as the signal is primarily ≤ 700 mV.

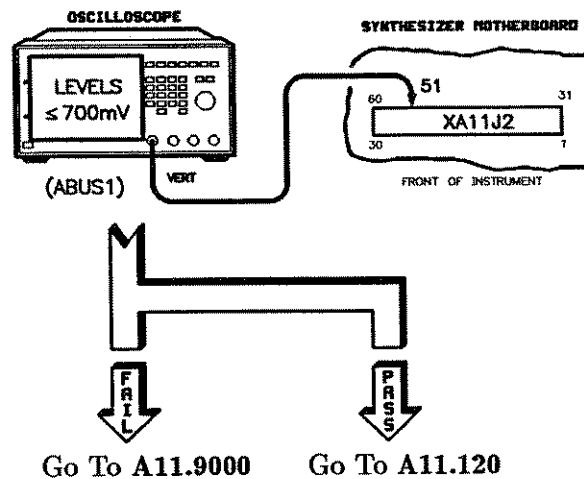

A11.110

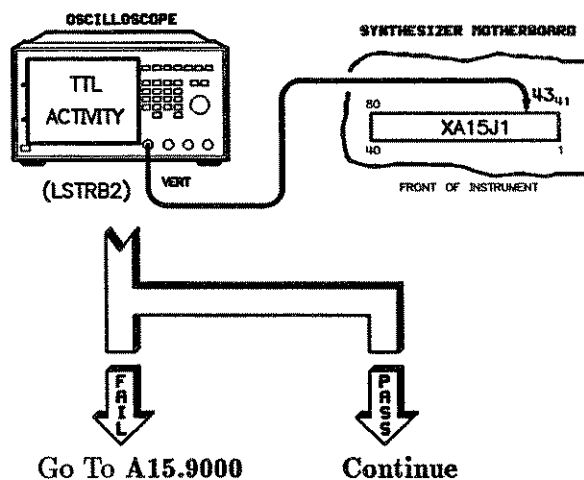

- A11.111** There is an open on the motherboard between XA11J1-26 and XA15J1-43. Verify this with an ohmmeter. Is jumpering the open an acceptable repair?



- A11.112** Install a jumper and go to the Troubleshooting Foldout, block 1 (located just prior to the "Special Cases" tab).

- A11.120** Verify a signal of ≤ 700 mV. However, expect some portions of the signal to rise to levels of up to 15 V dc. This is not a failure as long as the signal is primarily ≤ 700 mV.

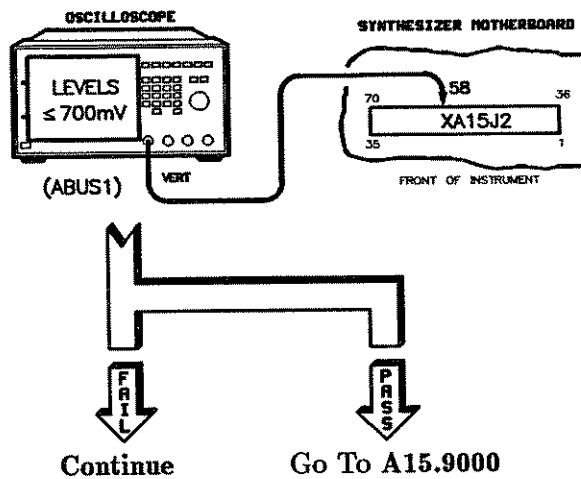

- A11.121** There is an open on the motherboard between XA11J1-51 and XA15J1-58. Verify this with an ohmmeter. Is jumpering the open an acceptable repair?

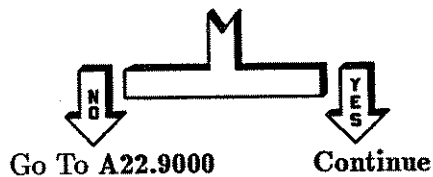

- A11.122** Install a jumper and go to the Troubleshooting Foldout, block 1 (located just prior to the "Special Cases" tab).

A11.200

Perform the following key sequence:

1. Press **PRESET** **SERVICE**.
2. Select **Selftest Menu**.
3. Press **148** **ENTER**.
4. Select **Loop** (asterisk on).
5. Select **Do Test #148**.

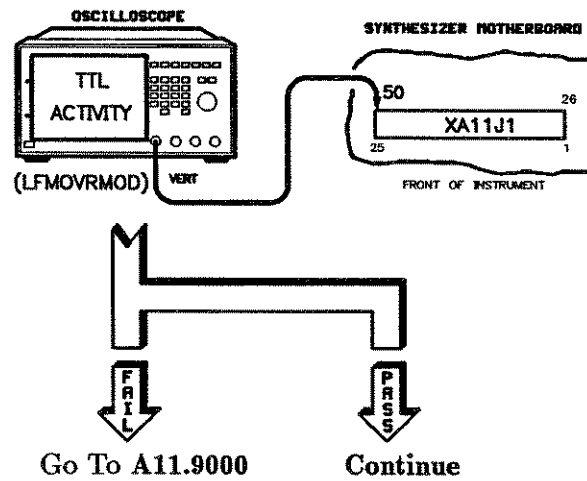

A11.201

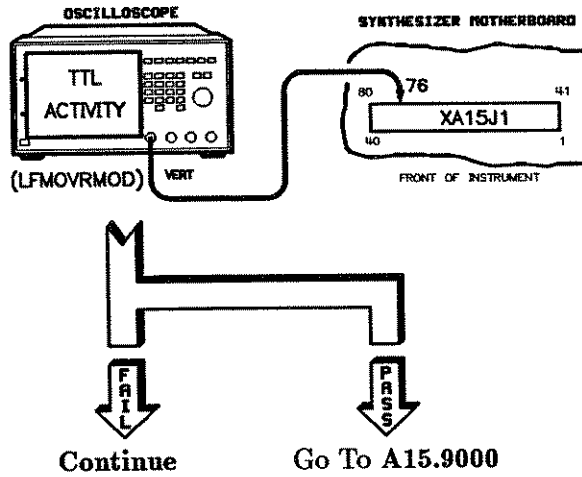

A11.202 There is an open on the motherboard between XA11J1-50 and XA15J1-76. Verify this with an ohmmeter. Is jumpering the open an acceptable repair?

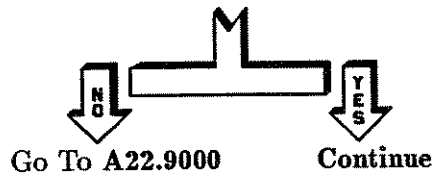

A11.203 Install a jumper and go to the Troubleshooting Foldout, block 1 (located just prior to the "Special Cases" tab).

A11.300

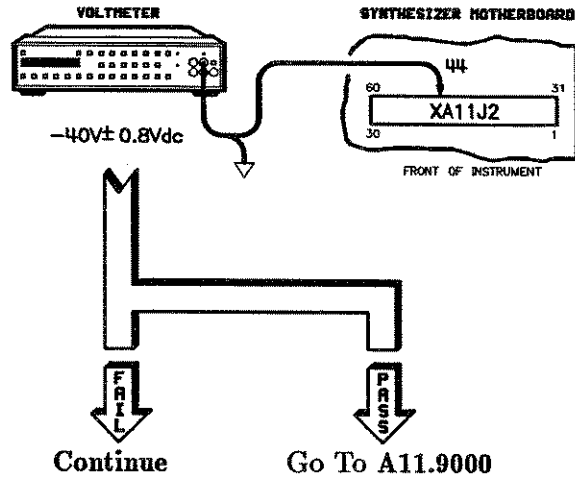

A11.301

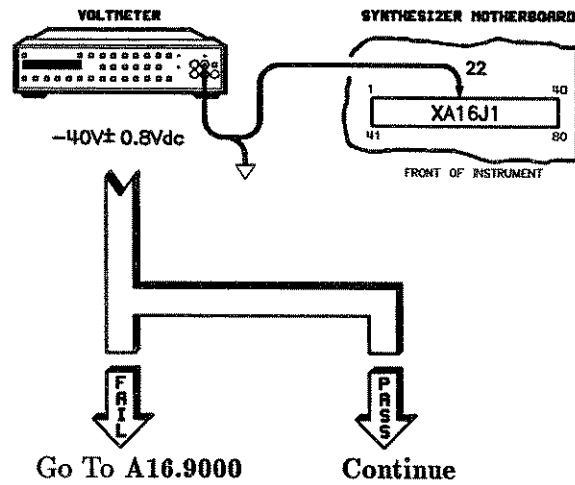

A11.302 An open exists between XA11J2-44 and XA16J1-22. Verify this with an ohmmeter. Is jumpering the open an acceptable repair?

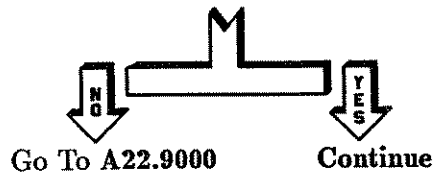

A11.303 Install a jumper and go to the Troubleshooting Foldout, block 1 (located just prior to the "Special Cases" tab).

A11.400

Are *all* cables removed from the synthesizer including connections to the FM input?

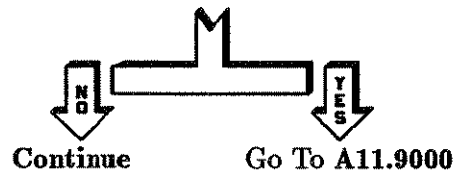

A11.401 Remove *all* cables and go to ILT.105.

A11.9000

Replace the A11 assembly.

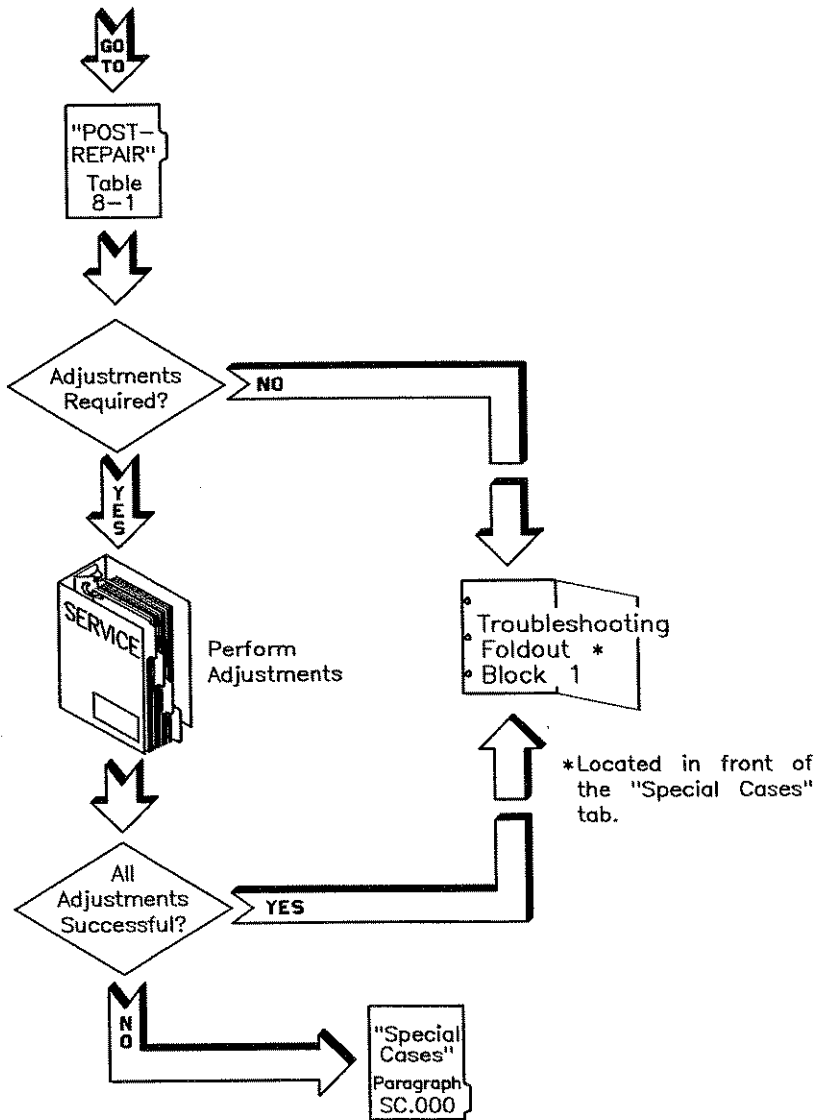

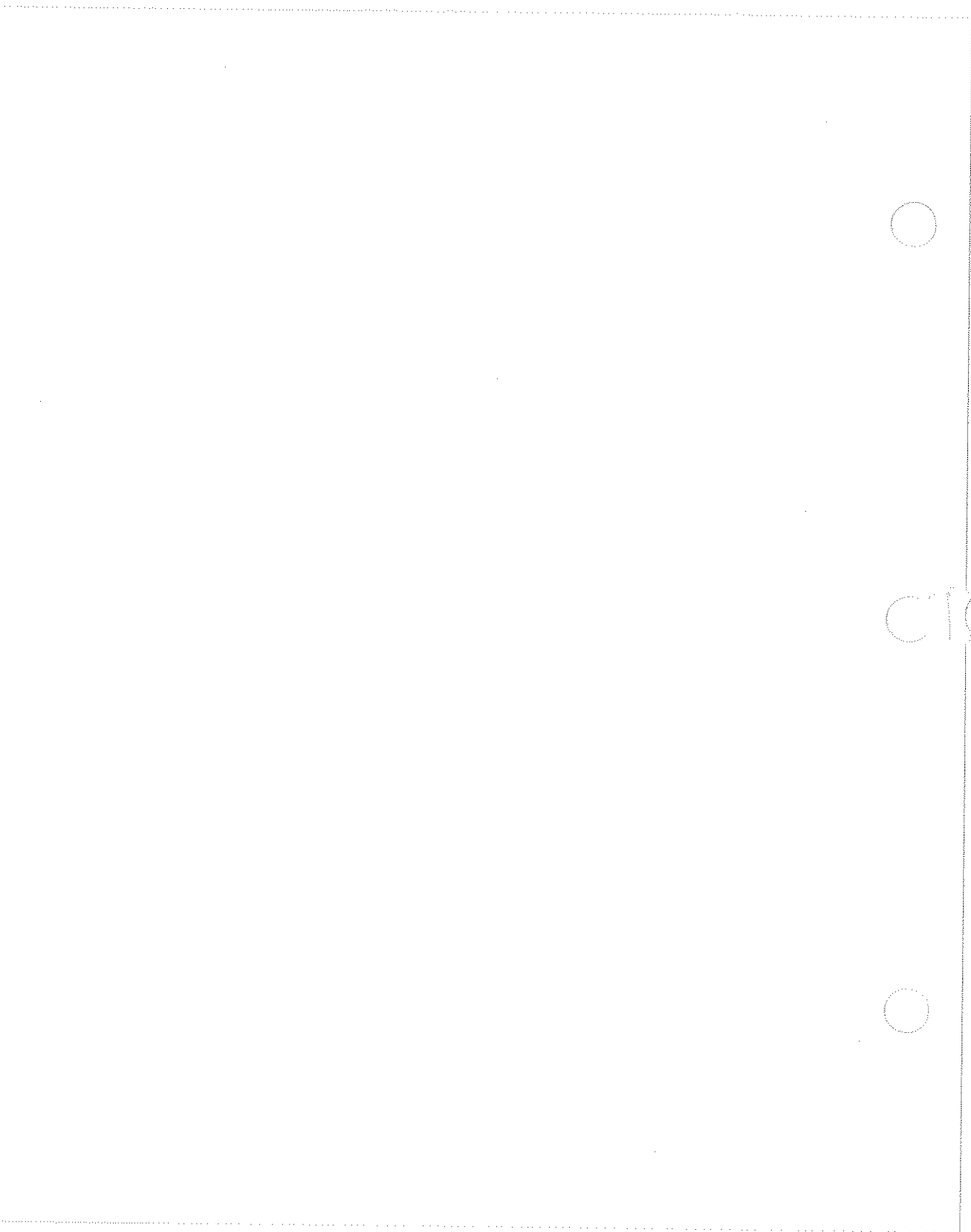

A12 Multiplier/Filter Driver Troubleshooting

A12.000	Message Displayed on Synthesizer	Go to Paragraph
	A12 : -10 V Supply	A12.100
	A12 : YTM Kick Circuit	A12.200
	A12 : Rise-time Comp Circuit	A12.300
	A12 : Output Driver	A12.400
	A12 : YO Error Attenuator	A12.500
	A12 : YTF Output Driver	A12.600
	A12 : Delay Offset DAC	A12.9000
	A12 : Delay Gain DAC	A12.9000
	A12 : Droop Circuit	A12.9000
	A12 : V/GHZ Buffer	A12.9000
	A12 : Rear Panel V/GHZ	A12.9000
	A12 : Offset DAC	A12.9000
	A12 : Slope DAC	A12.9000
	A12 : VCOMP Summer	A12.9000
	A12 : V/GHZ Attenuator	A12.9000
	A12 : Track/Hold Circuit	A12.9000
	A12 : YTM Tune in LO Band	A12.9000
	A12 : YTF Kick	A12.9000
	A12 : YTF Delay Offset DAC	A12.9000

A12 : YTF Delay Gain DAC	A12.9000
A12 : YTF Offset DAC	A12.9000
A12 : YTF Slope DAC	A12.9000
A12 : YTF VCOMP Summer	A12.9000

2 A12 Multiplier/Filter Driver Troubleshooting

A12.100

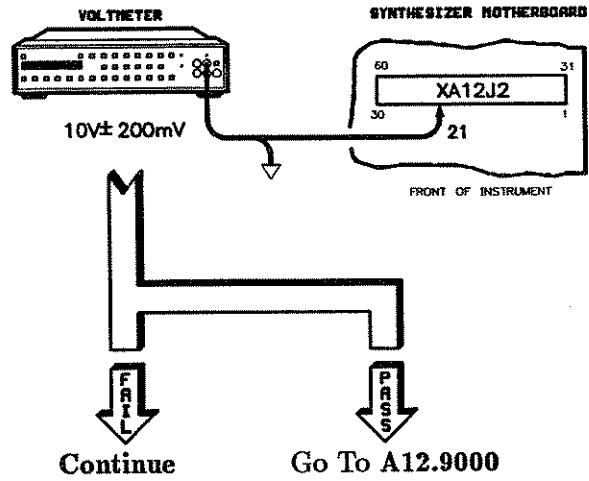

A12.101

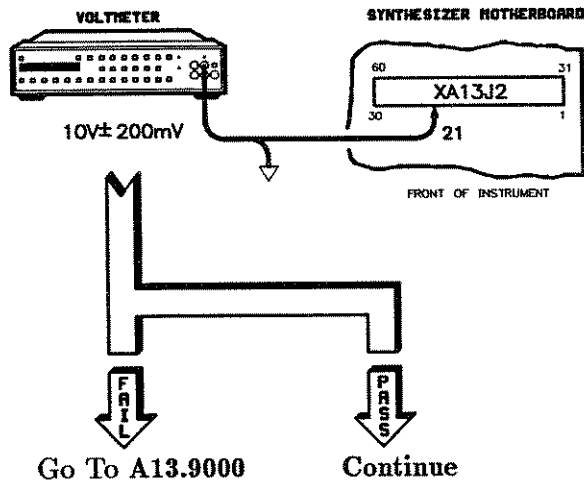

A12.110 There is an open on the motherboard between XA13J2-2 and XA12J2-21. Verify this with an ohmmeter. Is jumpering the open an acceptable repair?

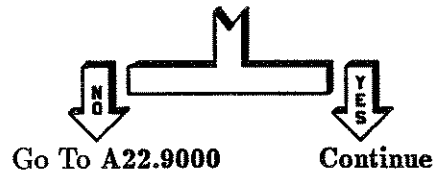

A12.111 Install a jumper and go to the Troubleshooting Foldout, block 1 (located just prior to the "Special Cases" tab).

A12.200

Perform the following key sequence:

1. Press **PRESET** **SERVICE**.
2. Select **Selftest Menu**.
3. Press **159** **ENTER**.
4. Select **Loop** (asterisk on).
5. Select **Do Test #159**.

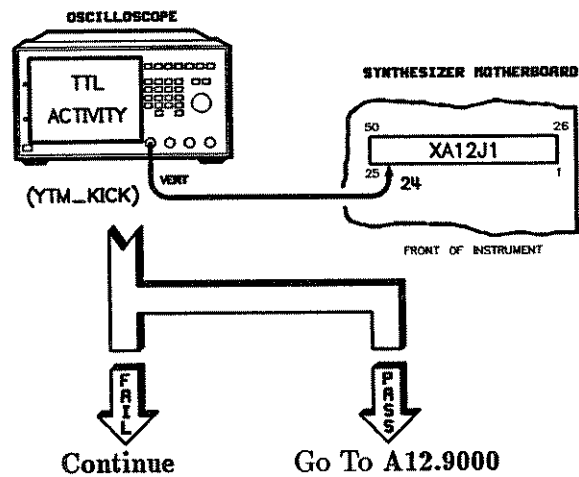

A12.201

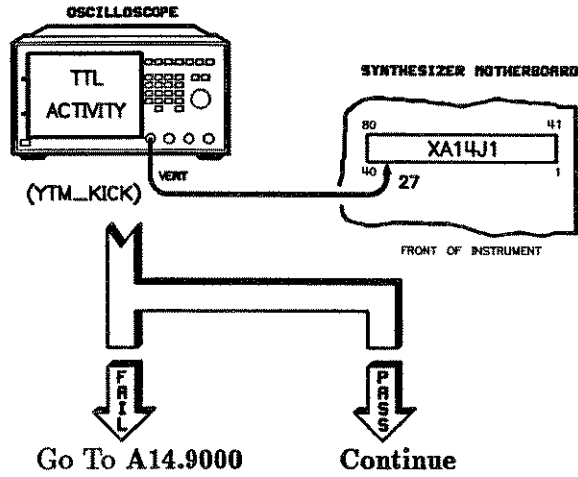

A12.210 There is an open on the motherboard between XA12J1-24 and XA14J1-27. Verify this with an ohmmeter. Is jumpering the open an acceptable repair?

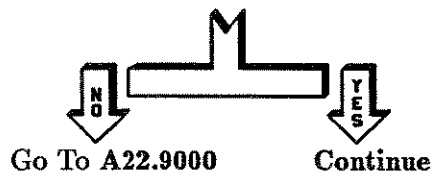

A12.211 Install a jumper and go to the Troubleshooting Foldout, block 1 (located just prior to the "Special Cases" tab).

A12.300

Perform the following key sequence:

1. Press **PRESET** **SERVICE**.
2. Select **Selftest Menu**.
3. Press **160** **ENTER**.
4. Select **Loop** (asterisk on).
5. Select **Do Test #160**.

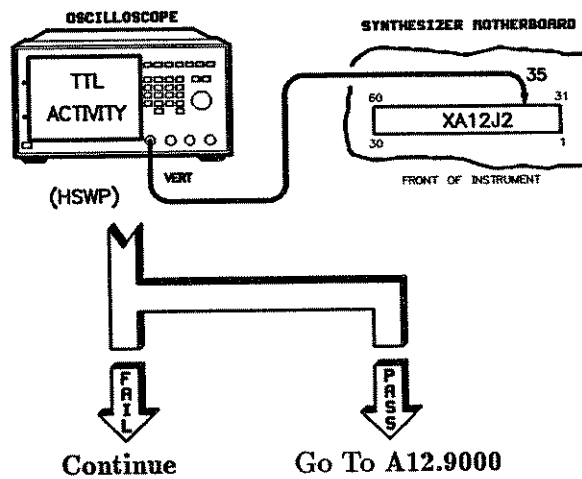

A12.301

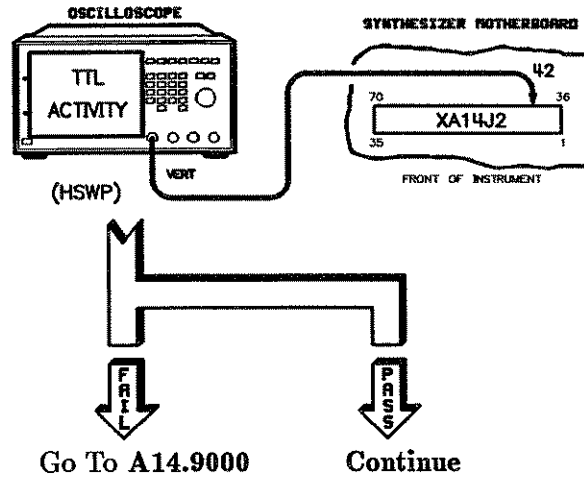

A12.310 There is an open on the motherboard between XA12J2-35 and XA14J2-42. Verify this with an ohmmeter. Is jumpering the open an acceptable repair?

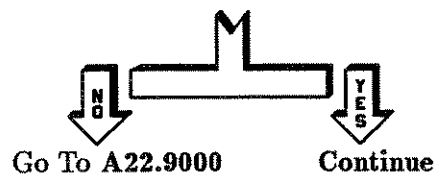

A12.311 Install a jumper and go to the Troubleshooting Foldout, block 1 (located just prior to the "Special Cases" tab).

A12.400

Do the following:

1. Set power switch to STANDBY.
2. Disconnect the power cord.
3. Measure the resistance of the YTM tuning coil from XA12J2-14 to XA12J2-60.

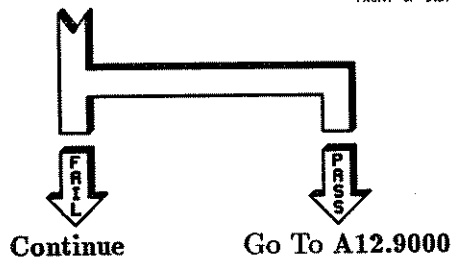
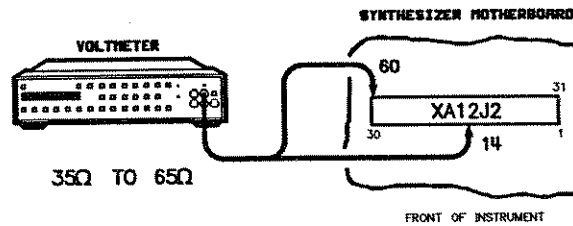

A12.401 Was the resistance $\leq 35\Omega$?

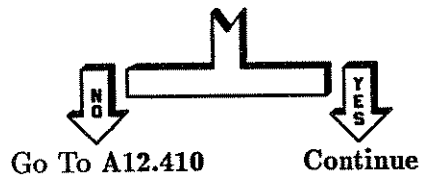

A12.402 Do the following:

1. Remove A12.
2. Measure the resistance of the SYTM tuning coil from XA12J2-14 to XA12J2-60.

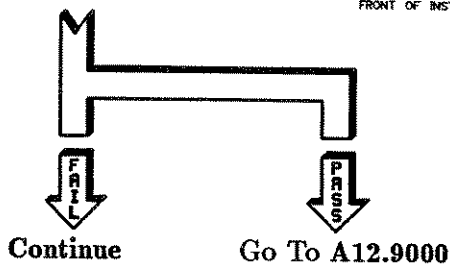
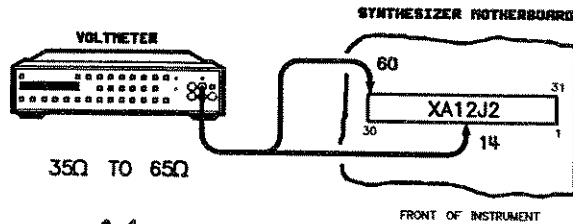

A12.403 Do the following:

- Disconnect W37 from A28J1 (ribbon cable connecting RF interface to amp/multiplier).
- Check for an open circuit between XA12J2-14 and XA12J2-60 ($\geq 100 \text{ k}\Omega$).

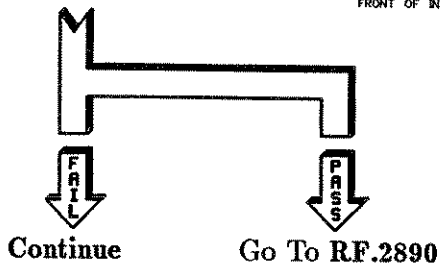
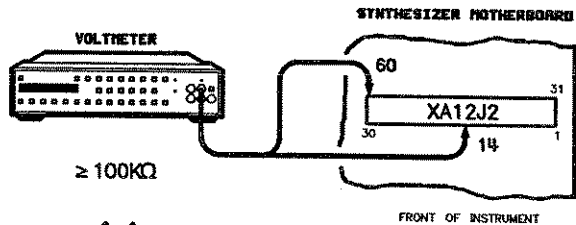

A12.400

Do the following:

1. Set power switch to STANDBY.
2. Disconnect the power cord.
3. Measure the resistance of the YTM tuning coil from XA12J2-14 to XA12J2-60.

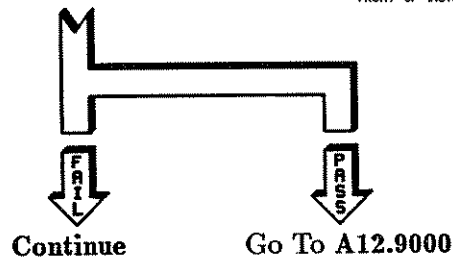
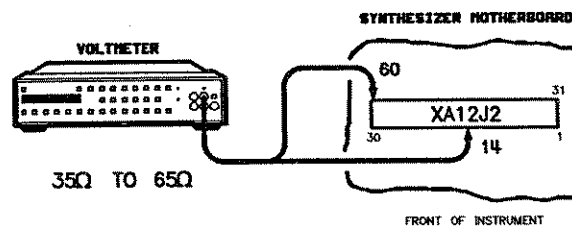

A12.401 Was the resistance $\leq 35\Omega$?

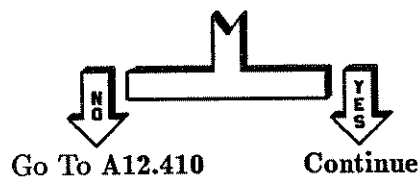

A12.402 Do the following:

1. Remove A12.
2. Measure the resistance of the SYTM tuning coil from XA12J2-14 to XA12J2-60.

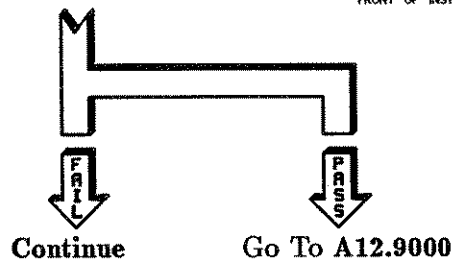
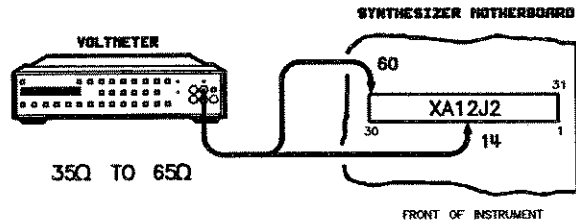

A12.403 Do the following:

- Disconnect W37 from A28J1 (ribbon cable connecting RF interface to amp/multiplier).
- Check for an open circuit between XA12J2-14 and XA12J2-60 ($\geq 100 \text{ k}\Omega$).

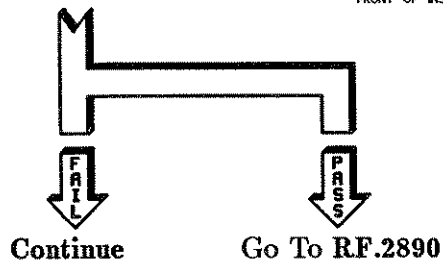
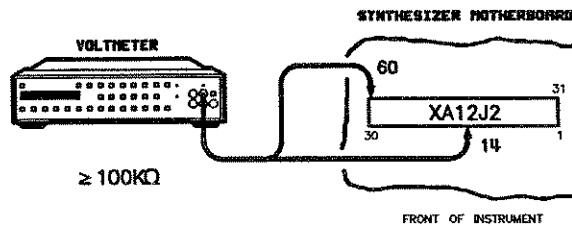

A12.404 Do the following:

- Using the disassembly instructions in the manual remove the RF Deck.
- Check for an open circuit between XA12J2-14 and XA12J2-60 ($\geq 100\text{ k}\Omega$).

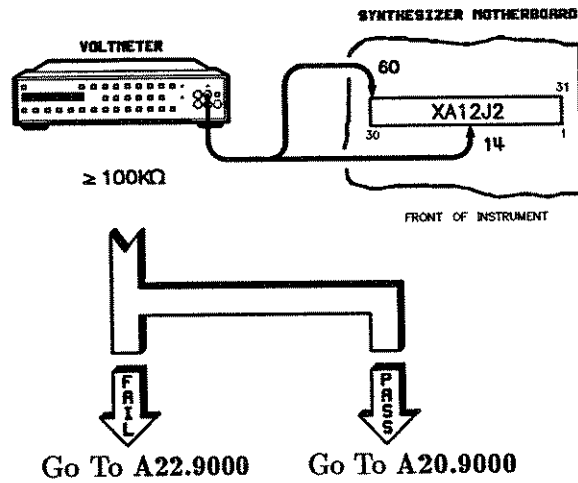

A12.410

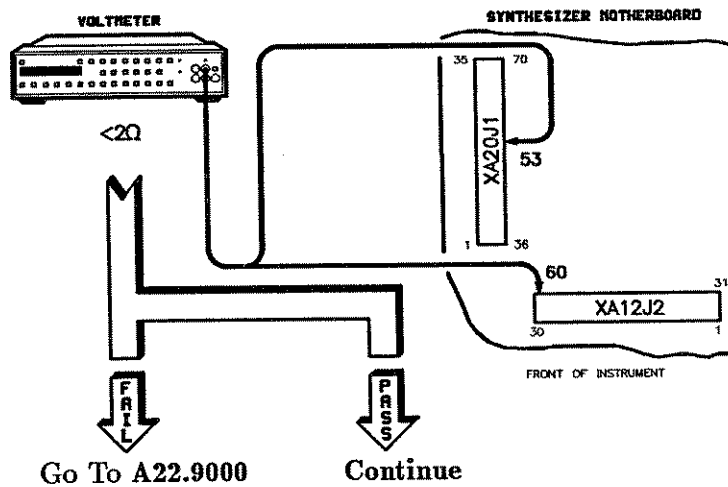

A12.411 Do the following:

- Using the disassembly instructions in the manual remove the RF deck.
- Disconnect W37 from A28 (amp/multiplier).
- Measure the resistance of the YTM coil at the amp/multiplier. The resistance should be ≥ 35 to $\leq 65\Omega$ between A28J7-4 and A28J7-12.

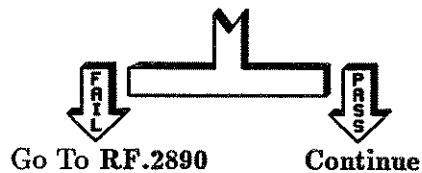

- A12.412** A high resistance exists on either W37 (the ribbon cable that connects the RF deck to A28) or on A20 itself (the RF interface assembly). Replace W37 or A20 and then go to the Troubleshooting Foldout, block 1 (located just prior to the “Special Cases” tab).

A12.500

Perform the following key sequence:

1. Press **PRESET** **SERVICE**.
2. Select **Selftest Menu**.
3. Press **170** **ENTER**.
4. Select **Log Output Menu** **When to Log Always** (asterisk on).
5. Press **PRIOR**.
6. Select **Do Test #170** **Cont** **Cont**.

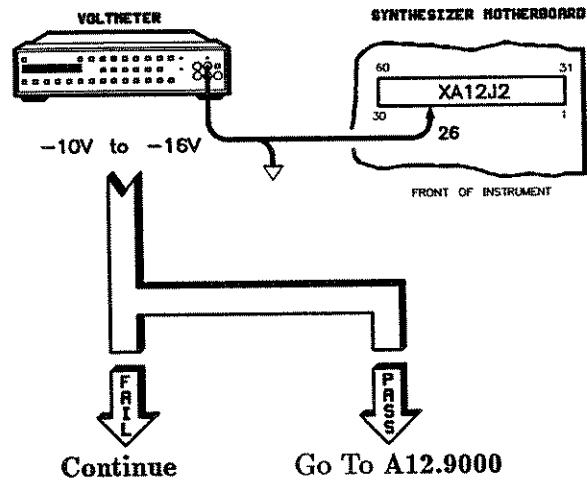

A12.501

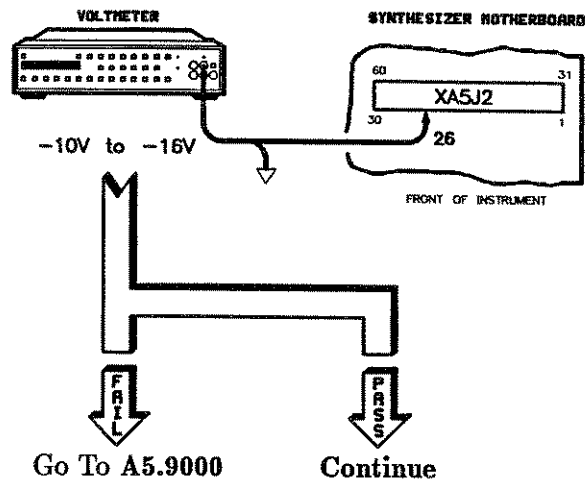

A12.502

There is an open on the motherboard between XA12J2-26 and XA5J2-26. Verify this with an ohmmeter. Is jumpering the open an acceptable repair?

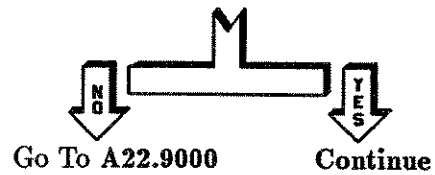

A12.503

Install a jumper and go to the Troubleshooting Foldout, block 1 (located just prior to the "Special Cases" tab).

A12.600

Do the following:

1. Set power switch to standby.
2. Disconnect the power cord.
3. Measure the resistance of the YTF tuning coil from XA12J2-44 to XA12J2-30.

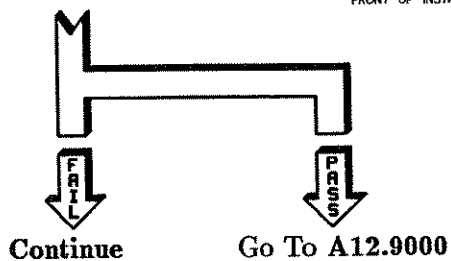
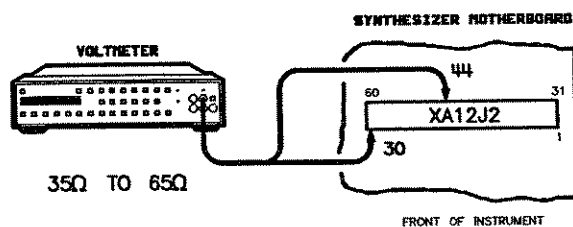

A12.601 Was the resistance $\leq 35\Omega$?

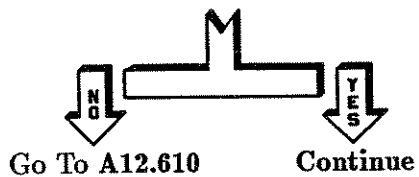

A12.602 Do the following:

1. Remove A12.
2. Measure the resistance of the YTF tuning coil from XA12J2-44 to XA12J2-30.

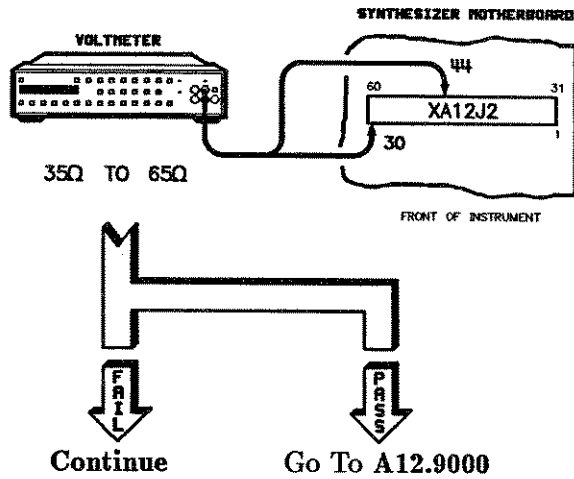

A12.603 Do the following:

- Disconnect W41 from A29J1 (ribbon cable connecting RF interface to amp/filter).
- Check for an open circuit between XA12J2-44 and XA12J2-30 ($\geq 100\text{ k}\Omega$).

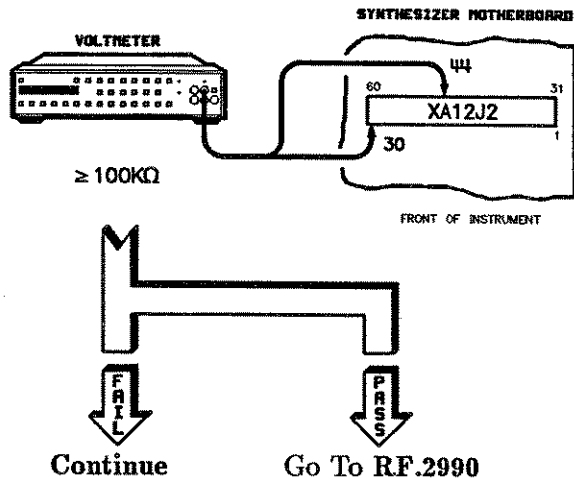

A12.604 Do the following:

- Using the disassembly instructions in the manual remove the RF Deck.
- Check for an open circuit between XA12J2-44 and XA12J2-30 ($\geq 100\text{ k}\Omega$).

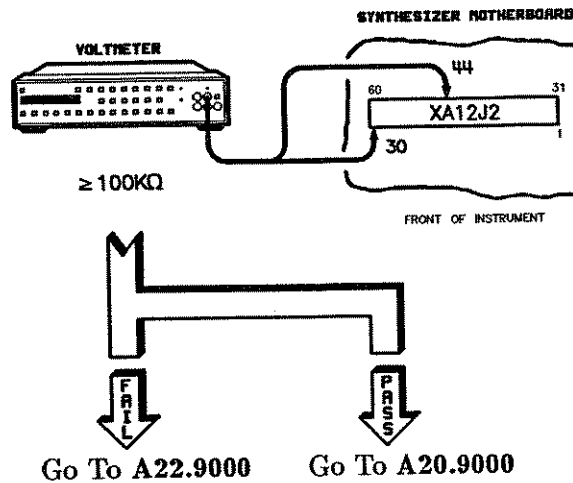

A12.610

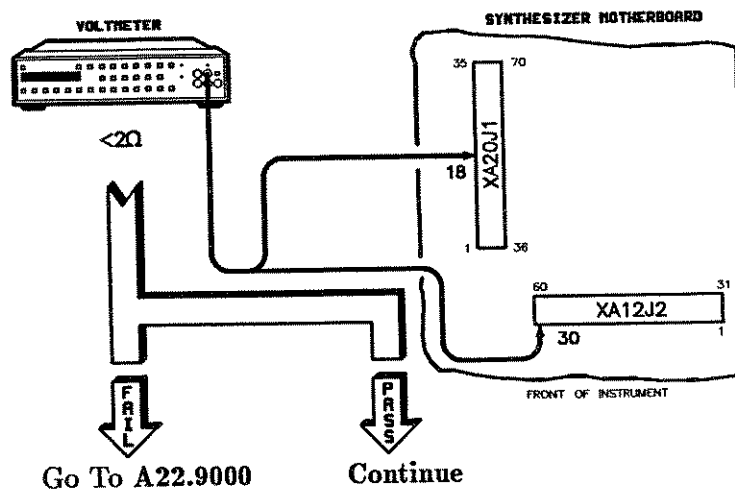

A12.611 Do the following:

- Using the disassembly instructions in the manual remove the RF deck.
- Disconnect W41 from A29 (amp/filter).
- Measure the resistance of the YTF coil at the amp/filter. The resistance should be ≥ 35 to $\leq 65\Omega$ between A29J7-4 and A29J7-12.

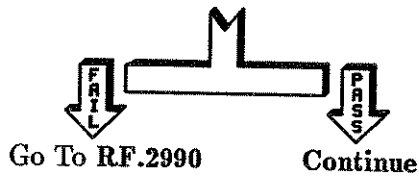

- A12.612** A high resistance exists on either W41 (the ribbon cable that connects the RF interface to A29) or on A20 itself (the RF interface assembly). Replace W41 or A20 and then go to the Troubleshooting Foldout, block 1 (located just prior to the “Special Cases” tab).

A12.9000

Replace the A12 assembly.

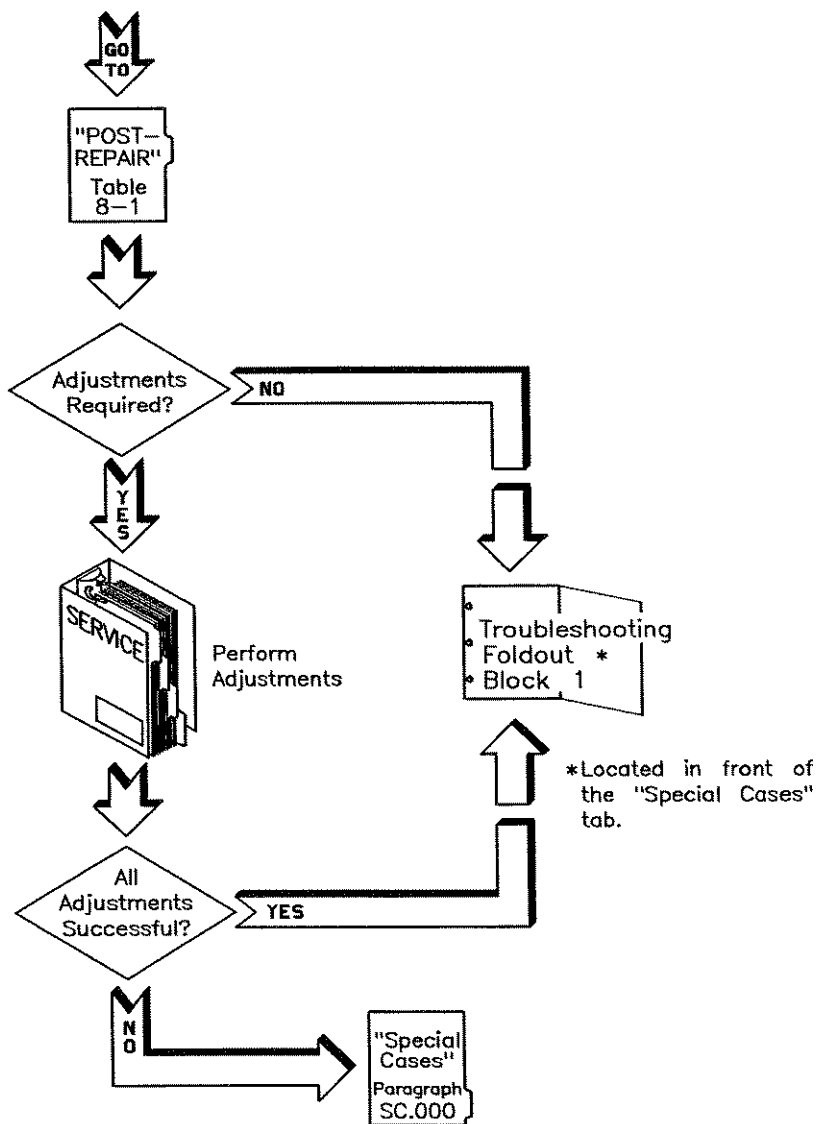

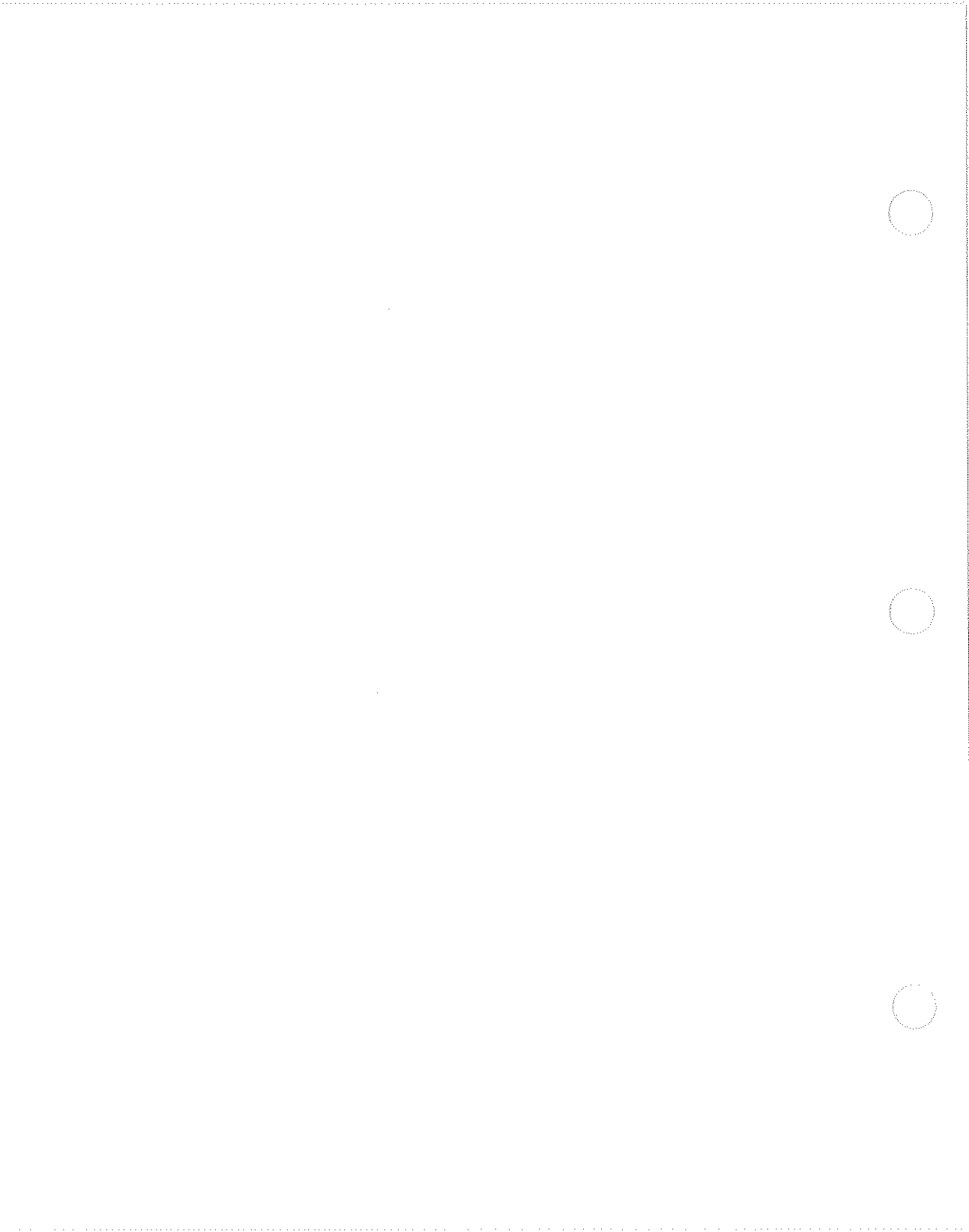

A13 YO Driver Troubleshooting

A13.000	Message Displayed on Synthesizer	Go to Paragraph
	A13 : +10V Reference	A13.100
	A13 : YO Kick Circuit	A13.200
	A13 : Width DAC [U3B]	A13.300
	A13 : Delay OFFST DAC [U10A]	A13.400
	A13 : YO Loop Error	A13.500
	A13 : Driver Amplifier	A13.600
	A13 : YO V/GHz Buffer	A13.9000
	A13 : CW DAC [U3B]	A13.9000
	A13 : Sweep Attenuator	A13.9000
	A13 : SWP Vern DAC [U16A]	A13.9000
	A13 : OFF Vern DAC [U16B]	A13.9000
	A13 : Delay GAIN DAC [U10B]	A13.9000
	A13 : Narrow/Wide Switch	A13.9000

A13.100

Perform self-test #182:

1. Remove the A10, A12, and A14 assemblies.
2. Press **PRESET** **SERVICE**.
3. Select **Selftest Menu**.
4. Press **182** **ENTER**.
5. Select **Loop** (asterisk on).
6. Select **Do Test #182**.

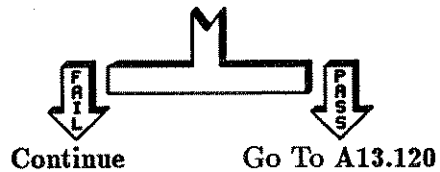

A13.101 Perform the following key sequence:

1. Press **PRESET** **SERVICE**.
2. Select **Selftest Menu**.
3. Press **232** **ENTER**.
4. Select **Loop** (asterisk on).
5. Select **Do Test #232**.

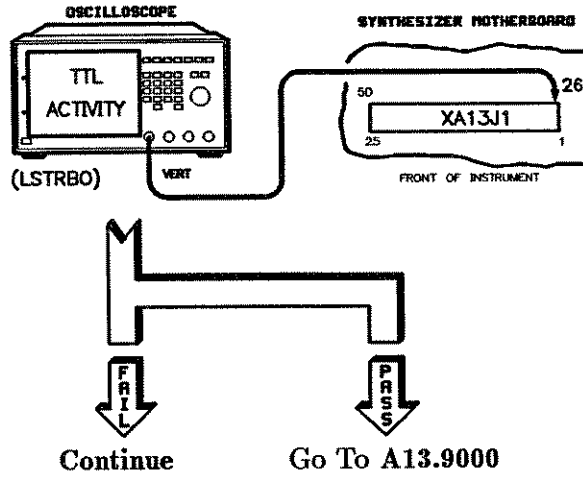

A13.102

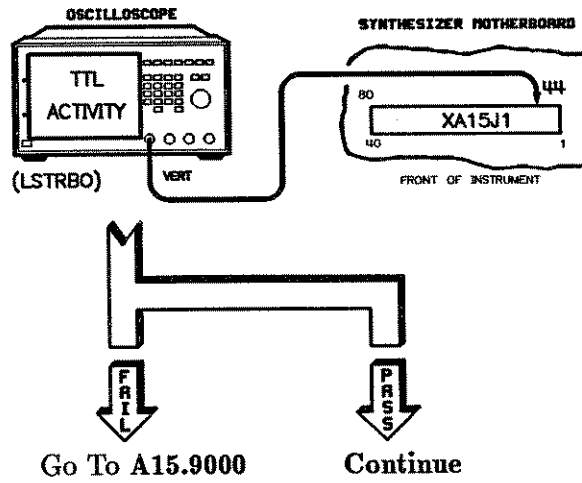

- A13.103** There is an open on the motherboard between XA13J1-26 and XA15J1-44. Verify this with an ohmmeter. Is jumpering the open an acceptable repair?

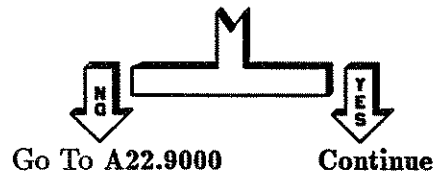

- A13.104** Install a jumper and go to the Troubleshooting Foldout, block 1 (located just prior to the "Special Cases" tab).

- A13.120** One of the following assemblies is defective:

A10 ALC.
A12 SYTM Driver.
A14 Sweep Generator.

Replace any one of the assemblies and perform the following test:

1. Press **PRESET** **SERVICE**.
2. Select **Selftest Menu**.
3. Press **182** **ENTER**.
4. Select **Do Test #182**.

If the test fails, the assembly just replaced is defective. If the test does not fail, replace another assembly and repeat test number 182. When the defective assembly is identified, go to the 9000 paragraph for that assembly for replacement instructions. For example, for A10 go to A10.9000, for A12, go to A12.9000, and so on.

A13.200

Perform the following key sequence:

1. Press **PRESET** **SERVICE**.
2. Select **Selftest Menu**.
3. Press **183** **ENTER**.
4. Select **Loop** (asterisk on).
5. Select **Do Test #183**.

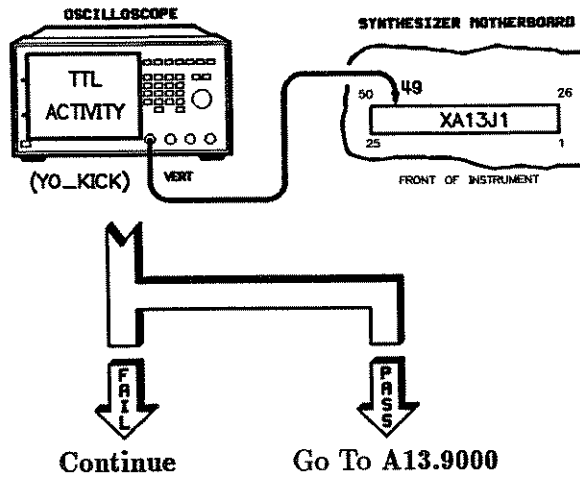

A13.201

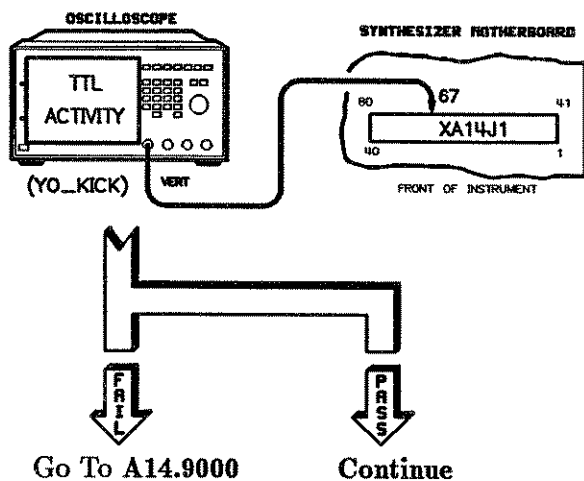

A13.202

There is an open on the motherboard between XA13J1-49 and XA14J1-67. Verify this with an ohmmeter. Is jumpering the open an acceptable repair?

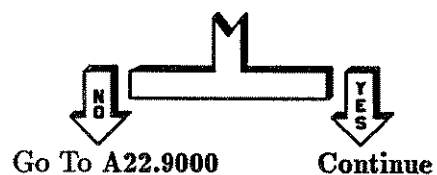

A13.203

Install a jumper and go to the Troubleshooting Foldout, block 1 (located just prior to the "Special Cases" tab).

A13.300

Perform the following key sequence:

1. Press **PRESET** **SERVICE**.
2. Select **Selftest Menu**.
3. Press **185** **ENTER**.
4. Select **Loop** (asterisk on).
5. Select **Do Test #185**.

When comparing the oscilloscope waveform to the one shown, the amplitude of the pulses is important; the timing is not.

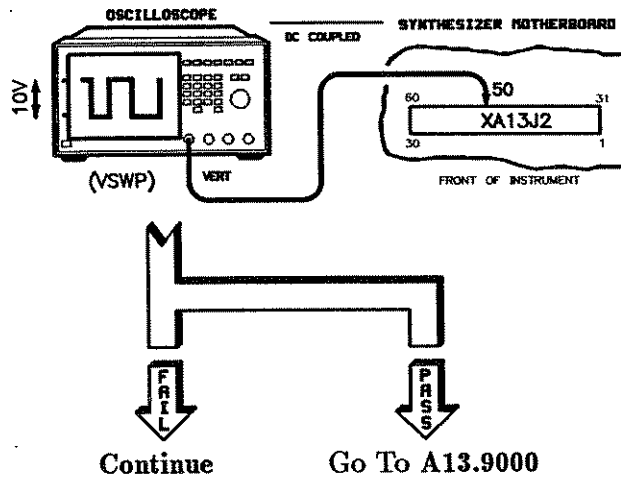

A13.301 When comparing the oscilloscope waveform to the one shown, the amplitude of the pulses is important; the timing is not.

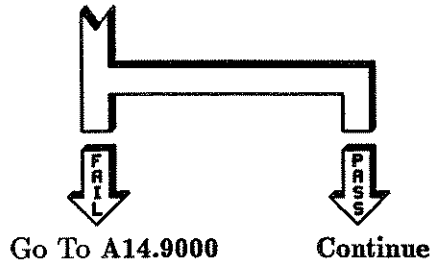
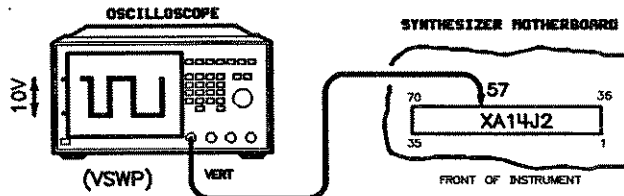

A13.302 There is an open on the motherboard between XA13J2-50 and XA14J2-57. Verify this with an ohmmeter. Is jumpering the open an acceptable repair?

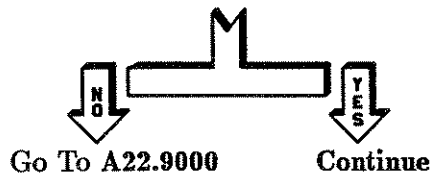

A13.303 Install a jumper and go to the Troubleshooting Foldout, block 1 (located just prior to the "Special Cases" tab).

A13.400

Perform the following key sequence:

1. Press **PRESET** **SERVICE**.
2. Select **Selftest Menu**.
3. Press **208** **ENTER**.
4. Select **Loop** (asterisk on).
5. Select **Do Test #208**.

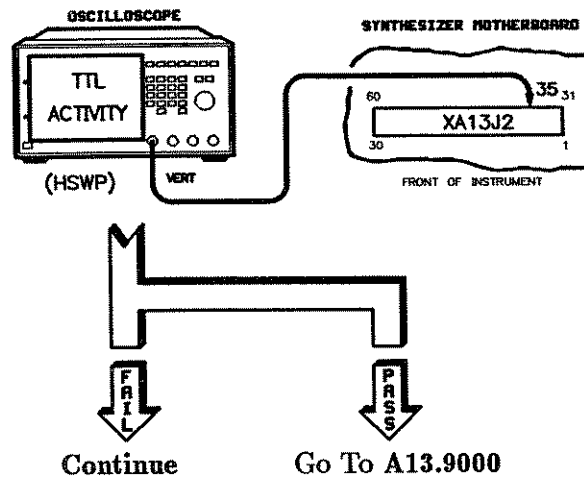

A13.401

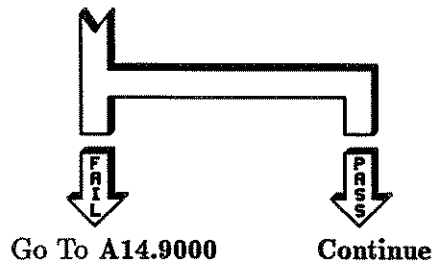
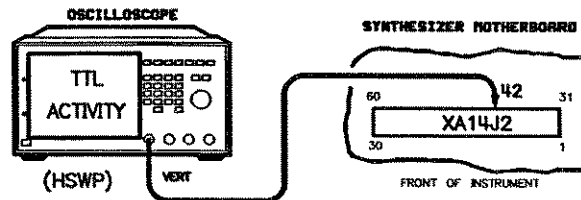

A13.402

There is an open on the motherboard between XA13J2-35 and XA14J2-42. Verify this with an ohmmeter. Is jumpering the open an acceptable repair?

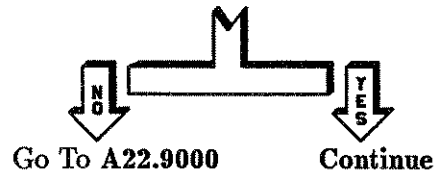

A13.403

Install a jumper and go to the Troubleshooting Foldout, block 1 (located just prior to the "Special Cases" tab).

A13.500

Perform the following key sequence:

1. Press **PRESET** **SERVICE**.
2. Select **Selftest Menu**.
3. Press **194** **ENTER**.
4. Select **Loop** (asterisk on).
5. Select **Do Test #194**.

When comparing the oscilloscope waveform to the one shown, the amplitude of the pulses is important; the timing is not.

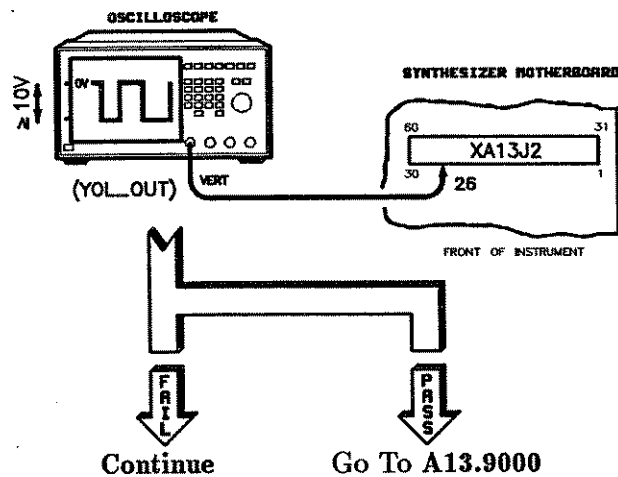

- A13.501** When comparing the oscilloscope waveform to the one shown, the amplitude of the pulses is important; the timing is not.

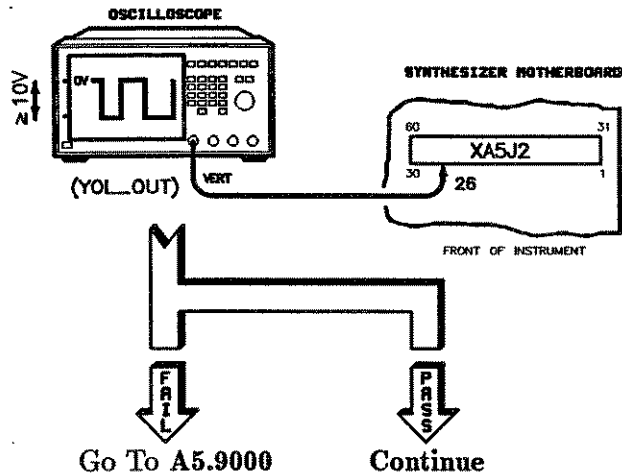

- A13.502** There is an open on the motherboard between XA13J2-26 and XA5J2-26. Verify this with an ohmmeter. Is jumpering the open an acceptable repair?

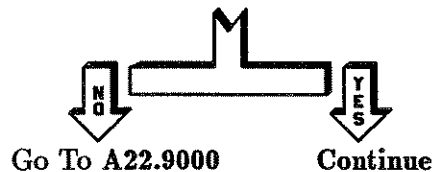

- A13.503** Install a jumper and go to the Troubleshooting Foldout, block 1 (located just prior to the "Special Cases" tab).

A13.600

Do the following:

1. Set the line power switch to STANDBY.
2. Disconnect the power cord.
3. Measure the resistance of the YO tuning coil.
XA13J2-14 to XA13J2-60 should be $\geq 35\Omega$ to $\leq 65\Omega$.

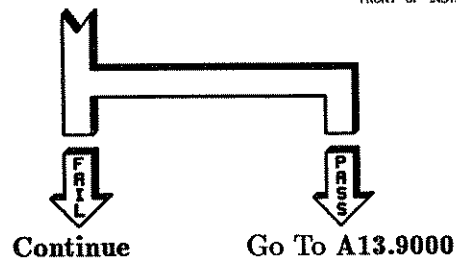
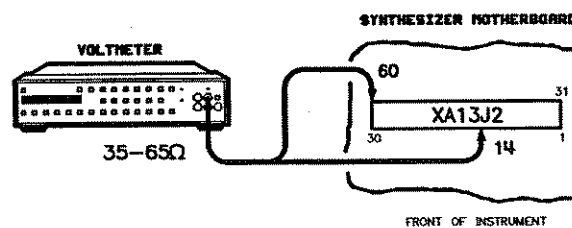

A13.601 Was the resistance $\leq 35\Omega$?

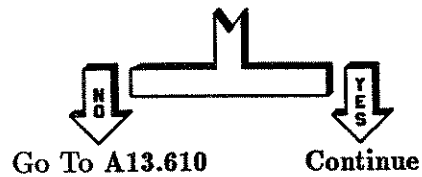

A13.602 Do the following:

1. Remove A13.
2. Measure the resistance of the YO tuning coil
(XA13J2-14 to XA13J2-60).

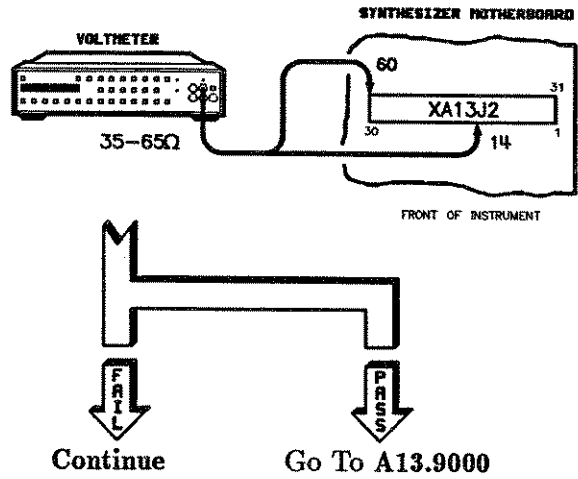

A13.603 Do the following:

1. Disconnect W42 from A26J1 (ribbon cable connecting RF interface to YO).
2. Check for an open circuit between XA13J2-14 and XA13J2-60 ($\geq 100\text{ k}\Omega$).

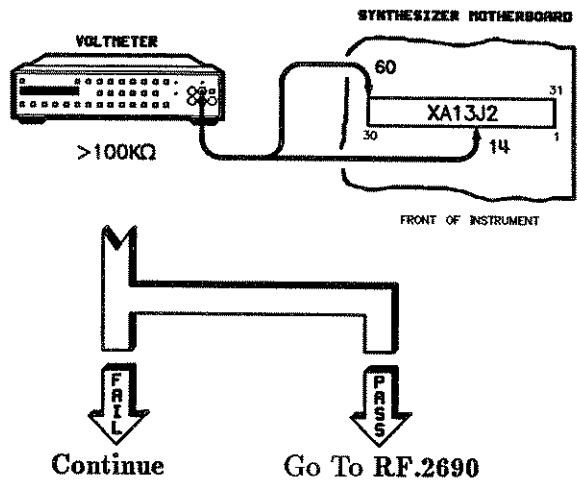

A13.604 Do the following:

1. Using the instructions in the "Disassembly and Replacement Procedures" chapter of the *Service Manual*, remove the RF deck.
2. Check for an open circuit between XA13J2-14 and XA13J2-60 ($\geq 100\text{ k}\Omega$).

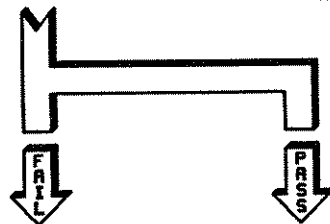
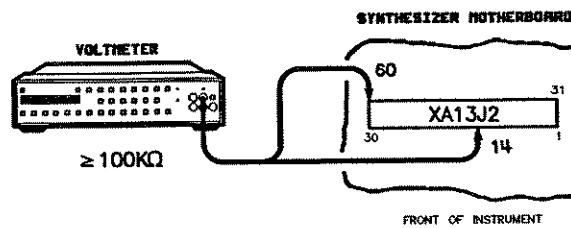

Go To A22.9000

Go To A20.9000

A13.610

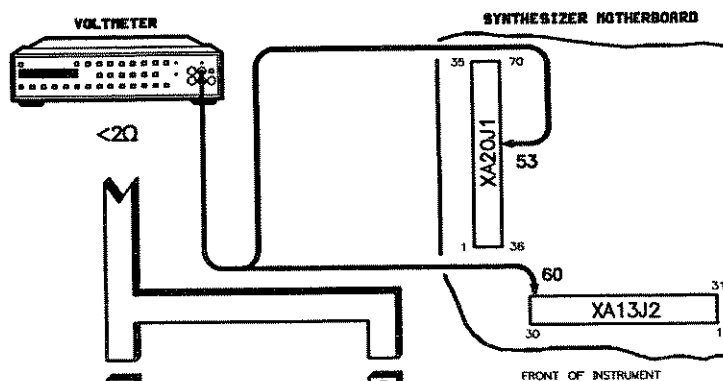

Go To A22.9000

Continue

A13.611 Perform the following:

1. Using the disassembly instructions in the manual, remove the RF deck.
2. Disconnect W42 from A26 (YO).
3. Measure the resistance of the YO coil at the YO. The resistance should be ≥ 35 to $\leq 65\Omega$ between A26J1-4 and A26J1-12.



Go To RF.2690

Continue

- A13.612** A high resistance exists on either W42 (ribbon cable that connects the RF deck to A26) or on A20 itself. Replace W42 or A20 and then go to the troubleshooting foldout, block 1 (located just prior to the “Special Cases” tab).

A13.9000

Replace the A13 assembly.

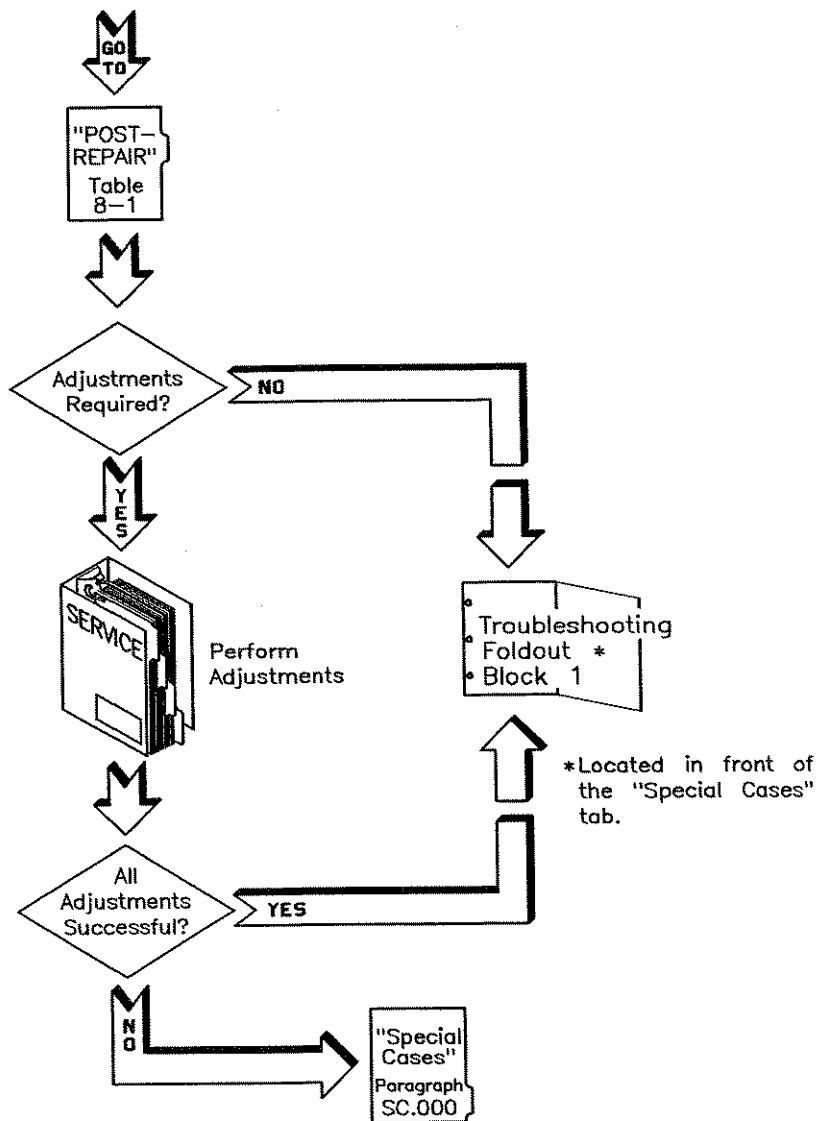

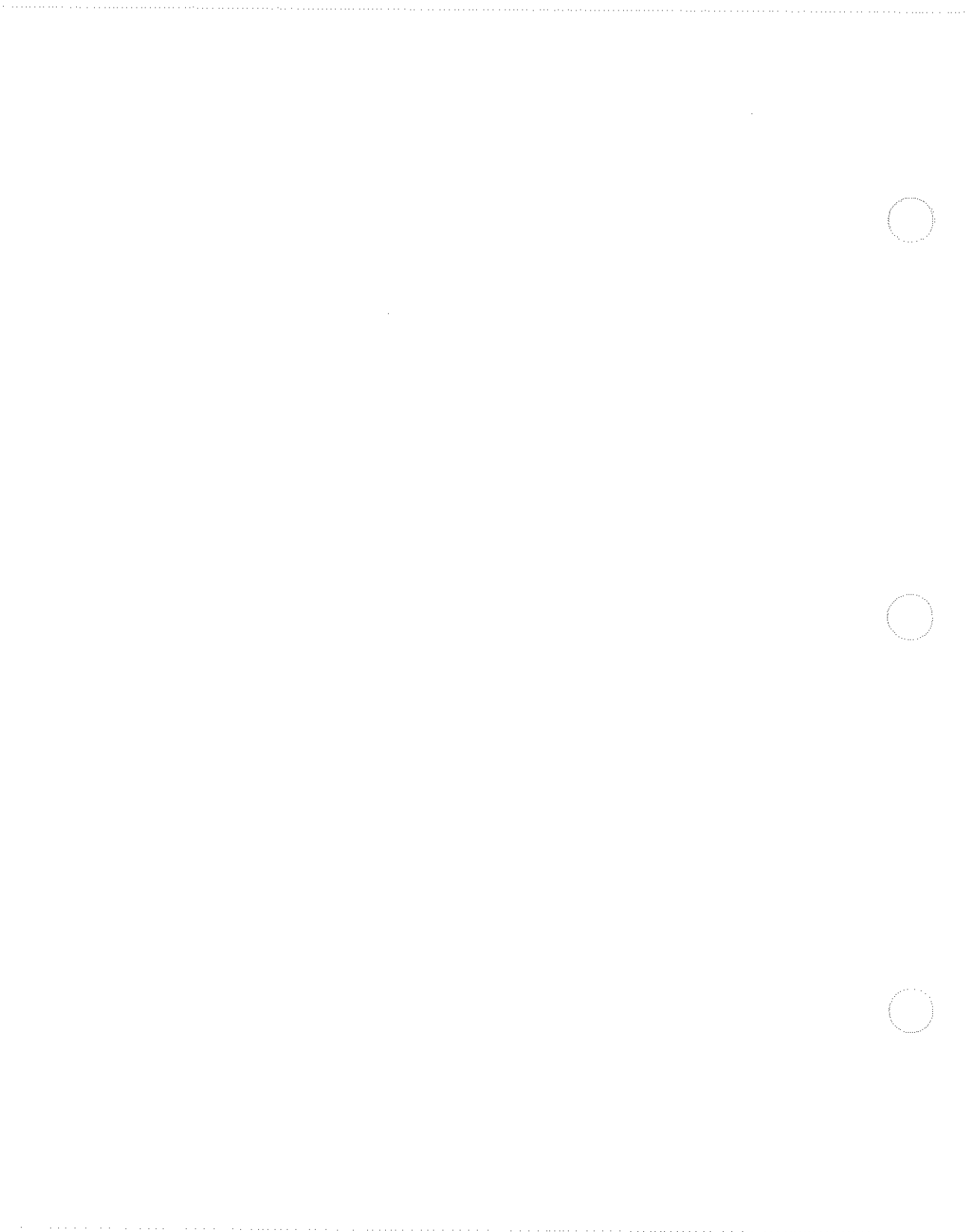

A14 Sweep Generator Troubleshooting

A14.000	Message Displayed on Synthesizer	Go to Paragraph
	A14 : -10VREF Supply	A14.100
	A14 : 1 MHz Clock	A14.200
	A14 : Sweep Status Line	A14.300
	A14 : Z-Axis Blanking	A14.400
	A14 : Rear Panel VSWP	A14.500
	A14 : Triple Timer U12	A14.9000
	A14 : Triple Timer U13	A14.9000
	A14 : Bucket Counter	A14.9000
	A14 : Event Latch/Buffer	A14.9000
	A14 : Event RAM	A14.9000
	A14 : Marker Control	A14.9000
	A14 : Stop Sweep Control	A14.9000
	A14 : Bucket Generator	A14.9000
	A14 : ABUS Ground	A14.9000
	A14 : Level Correction DAC	A14.9000
	A14 : Sweeptime DAC	A14.9000
	A14 : VSWP Output	A14.9000
	A14 : Ramp Generator	A14.9000
	A14 : Reset Loop	A14.9000

A14.100

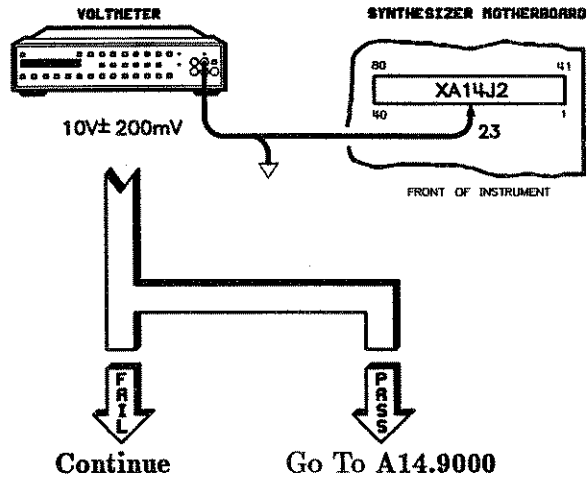

A14.101

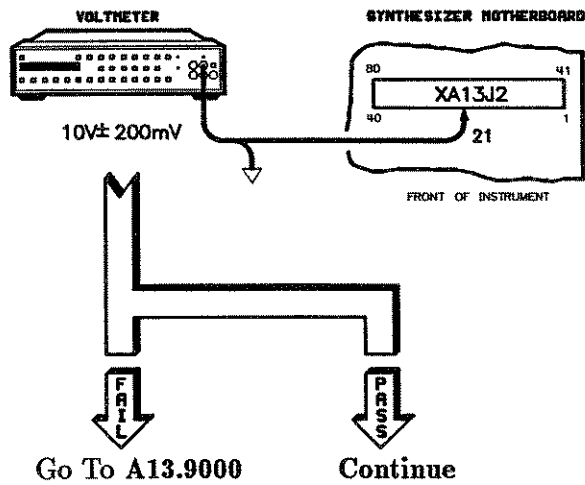

A14.110 There is an open on the motherboard between XA14J2-23 and XA13J2-21. Verify this with an ohmmeter. Is jumpering the open an acceptable repair?

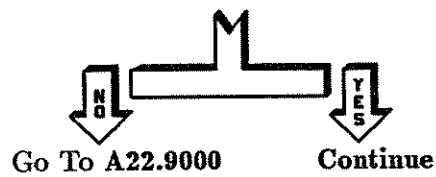

A14.111 Install a jumper and go to the Troubleshooting Foldout, block 1 (located just prior to the “Special Cases” tab).

A14.200

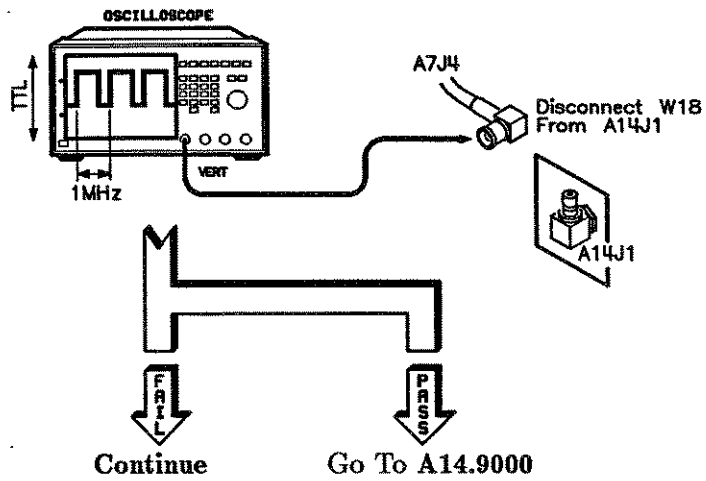

A14.201

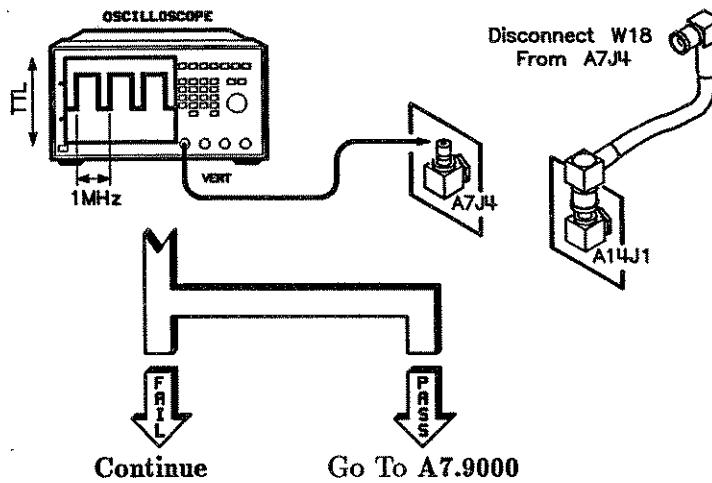

A14.210 W18 is open or damaged. Replace W18 and then go to the Troubleshooting Foldout, block 1 (located just prior to the “Special Cases” tab).

A14.300

Perform the following key sequence:

1. Press **PRESET** **SERVICE**.
2. Select **Selftest Menu**.
3. Press **209** **ENTER**.
4. Select **Loop** (asterisk on).
5. Select **Do Test #209**.

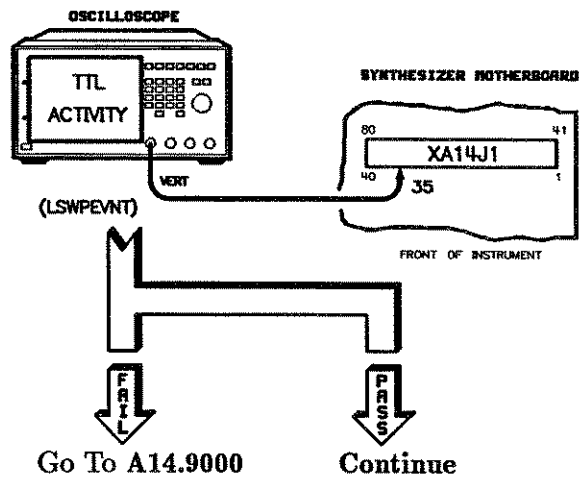

A14.301

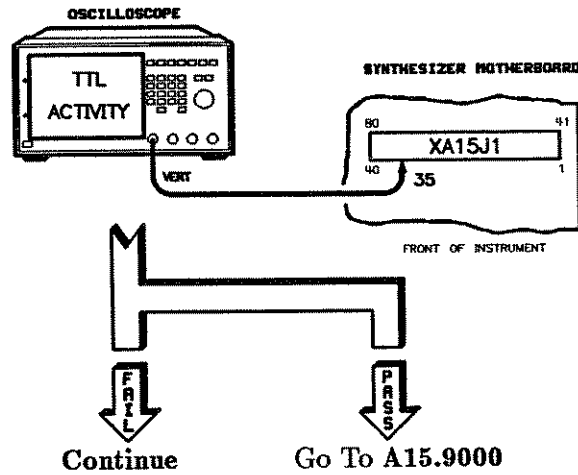

- A14.310** There is an open on the motherboard between XA14J1-35 and XA15J1-35. Verify this with an ohmmeter. Is jumpering the open an acceptable repair?

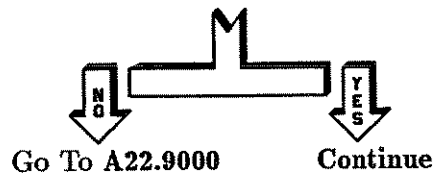

- A14.311** Install a jumper and go to the Troubleshooting Foldout, block 1 (located just prior to the "Special Cases" tab).

A14.400

Do the following:

1. Set the line power switch to STANDBY.
2. Unplug the line power cord.
3. Measure the resistance between XA14J1-78 and ground ($\geq 10\text{ k}\Omega$).

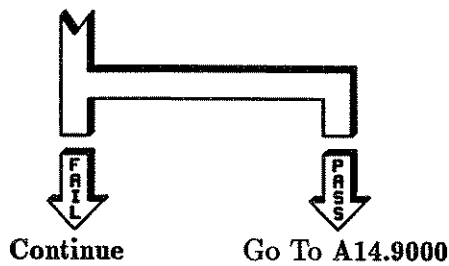
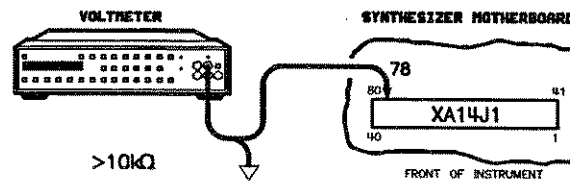

A14.401 Do the following:

1. Ensure the instrument is still disconnected from line power.
2. Remove A14.
3. Measure the resistance between XA14J1-78 and ground ($\geq 10\text{ k}\Omega$).

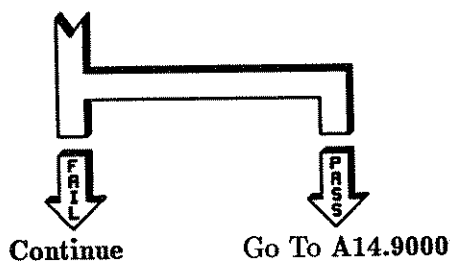
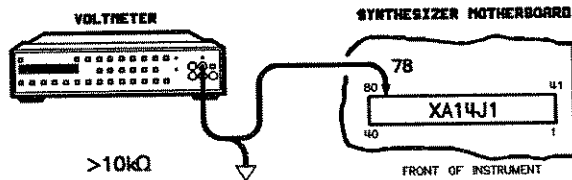

A14.402 Do the following:

1. Ensure the instrument is still disconnected from line power.
2. Remove the rear panel.
3. Disconnect the ribbon cable connecting A19 to the motherboard (W31).
4. Measure the resistance between XA14J1-78 and ground ($\geq 10 \text{ k}\Omega$).

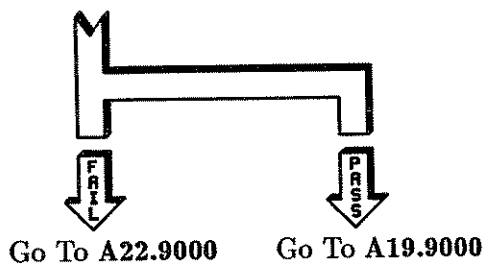
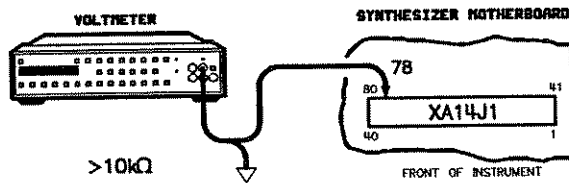

A14.500

Are *all* cables removed from the synthesizer including the VSWP connection?

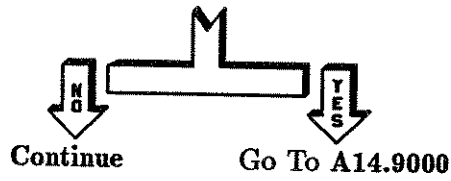

A14.501 Remove *all* cables and go to ILT.105.

A14.9000

Replace the A14 assembly.

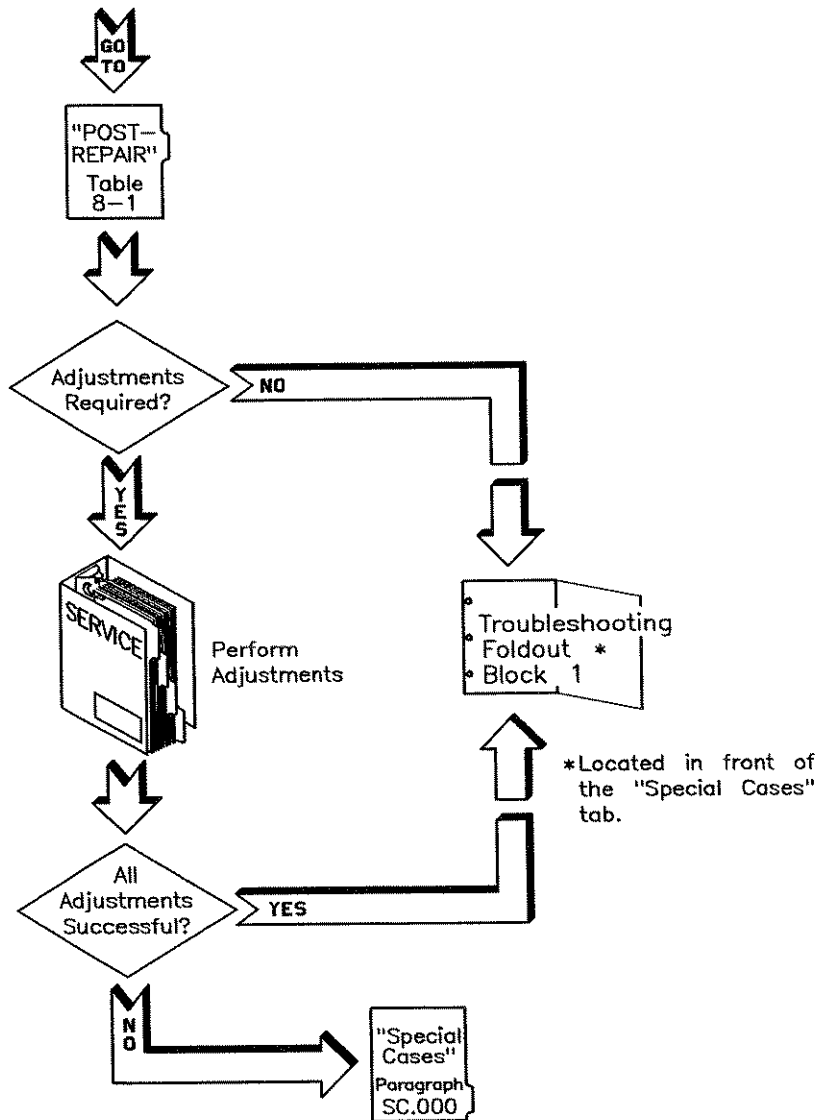

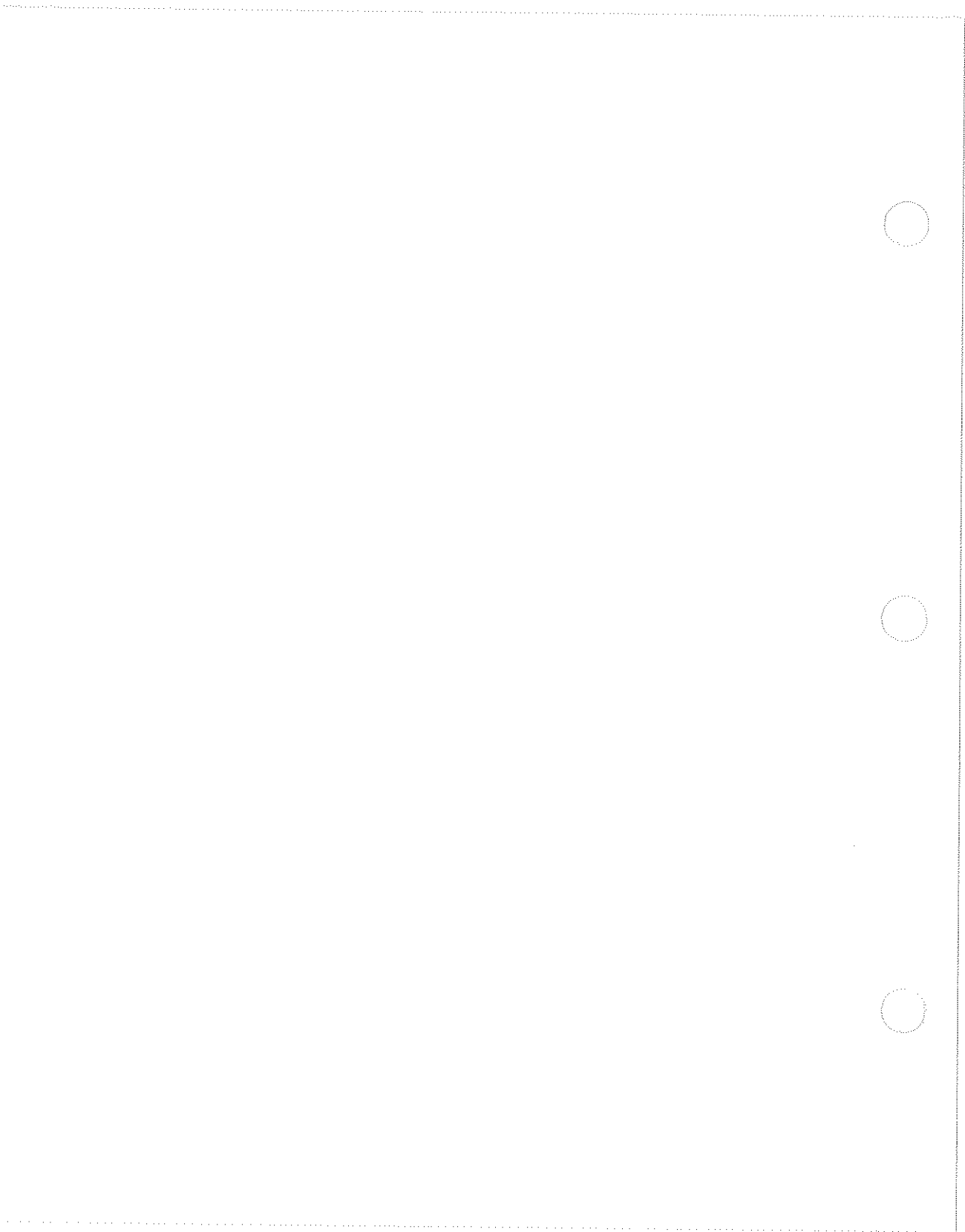

A15 CPU Troubleshooting

A15.000	Message Displayed on Synthesizer	Go to Paragraph
	A15 : I/O Address	A15.100
	A15 : I/O Strobe	A15.200
	A15 : I/O Data	A15.300
	A15 : ROM Tests	A15.400
	A15 : HPIB Interface Chips	A15.500
	A15 : ADC Circuitry	A15.9000
	A15 : uProcessor Test	A15.9000
	A15 : Peripheral/Timers	A15.9000
	A15 : RAM Tests	A15.9000

A15.100 Perform the following setup:

1. Set the line power switch to STANDBY.
2. Completely remove the following assemblies:
 - A4 fractional-N.
 - A5 YO loop.
 - A7 reference.
 - A9 pulse.
 - A10 ALC.
 - A11 FM driver.
 - A12 SYTM driver.
 - A13 YO driver.
 - A14 sweep generator.
3. Set the line power switch to ON.
4. Press **PRESET** **SERVICE**.
5. Select **Selftest Menu**.
6. Press **231** **ENTER**.
7. Select **Do Test #231**.

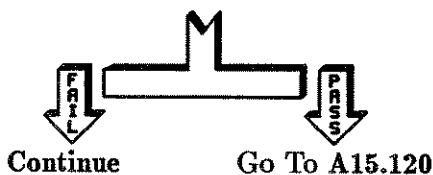

A15.101 Perform the following setup:

1. Set the line power switch to STANDBY.
2. Replace all of the assemblies removed in the previous step and reconnect all cables.
3. Carefully remove the A6 assembly. Be sure to disconnect all flexible and semi-rigid coax cables before removing A6.
4. Set the line power switch to ON.
5. Press **PRESET** **SERVICE**.
6. Select **Selftest Menu**.
7. Press **231** **ENTER**.

8. Select **Do Test #231**.



A15.102 Perform the following setup:

1. Set the line power switch to **STANDBY**.
2. Disconnect the line power cord.
3. Wait for all the indicators in the power supply section to go out.
4. Replace the A6 assembly (removed in the previous step) and reconnect all cables.
5. Using the disassembly instructions, remove the front panel and disconnect W2 (the ribbon cable that connects the motherboard to A2.)
6. Temporarily replace the front panel leaving W2 loose.
7. Reconnect line power (the power-on control is on A2 so the synthesizer will power up automatically, even in standby).
8. Press **PRESET SERVICE**.
9. Select **Selftest Menu**.
10. Press **231 ENTER**.
11. Select **Do Test #231**.

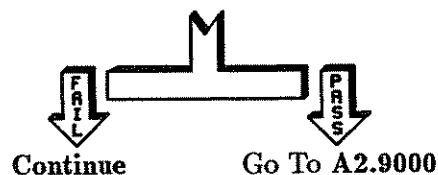

A15.103 Perform the following setup:

1. Disconnect the line power cord.
2. Wait for all the indicators in the power supply section to go out.
3. Remove the front panel.
4. Reconnect W2 to A2.
5. Disconnect W3 (the ribbon cable that connects A3 to the motherboard.)
6. Temporarily replace the front panel leaving the ribbon cable loose.
7. Reconnect the line power cord.
8. Set the line power switch to ON.
9. Observe the red indicators on A15.

Are all A15 indicators off?



Warning



When the instrument is connected to ac line power or the A18 high voltage neon indicator is on, there are voltages present that can cause personal injury or death. Only trained, qualified personnel, who are aware of the hazards involved, should perform service on this instrument with its protective covers removed.

A15.104 Perform the following setup:

1. Set the line power switch to STANDBY.
2. Disconnect the line power cord.
3. Wait for all the indicators in the power supply section to go out.
4. Remove the front panel and reconnect W3 (the ribbon cable that connects A3 to the motherboard.)
5. Reinstall the front panel.

6. Remove the rear panel and disconnect W31 (the ribbon cable that connects the motherboard to A19.) Refer to the disassembly procedures as needed.
7. Temporarily replace the rear panel leaving the ribbon cable (W31) loose. Take great care to ensure that the ribbon cable is not in contact with any line power wires or connections.
8. Reconnect the line power cord.
9. Set the line power switch to ON.
10. Press **PRESET** **SERVICE**.
11. Select **Selftest Menu**.
12. Press **231** **ENTER**.
13. Select **Do Test #231**.

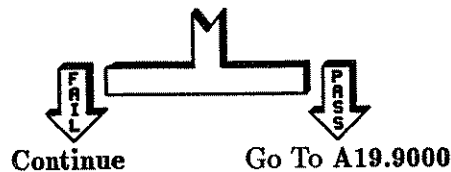

A15.105 Perform the following setup:

1. Set the line power switch to STANDBY.
2. Disconnect the line power cord.
3. Wait for all the indicators in the power supply section to go out.
4. Reconnect W31 (the ribbon cable that connects A19 to the motherboard.)
5. Remove the RF deck. Refer to the disassembly procedures as needed.
6. Reconnect the line power cord.
7. Set the line power switch to ON.
8. Press **PRESET** **SERVICE**. Ignore all unlevelled indications.
9. Select **Selftest Menu**.
10. Press **231** **ENTER**.

11. Select **Do Test #231**.



Go To A15.8500 Go To A20.9000

A15.120 One of the following assemblies is defective:

- A4 fractional-n.
- A5 YO loop.
- A7 reference.
- A9 pulse.
- A10 ALC.
- A11 FM driver.
- A12 SYTM driver.
- A13 YO driver.
- A14 sweep generator.

Replace any one of the assemblies and perform the following test:

1. Press **PRESET** **SERVICE**.
2. Select **Selftest Menu**.
3. Press **231** **ENTER**.
4. Select **Do Test #231**.

If the test fails, the assembly just replaced is defective. If the test does not fail, replace another assembly and repeat test number 231. When the defective assembly is identified, go to the 9000 paragraph for that assembly for replacement instructions. For example, for A4, go to A4.9000, for A5, go to A5.9000, and so on.

A15.200 Perform the following setup:

1. Set the line power switch to ON.
2. Press **PRESET** **SERVICE**.
3. Select **Selftest Menu**.
4. Press **232** **ENTER**.
5. Select **Log Output Menu** **When to Log Always** (asterisk on).
6. Press **PRIOR**.
7. Select **Do Test #232**.
8. Press **Continue**. Note the fail or pass status of each strobe.
9. Use the following table to determine your next step.

Strobes	Go To Paragraph
Only strobe #0 fails	A15.210
Only strobe #1 fails	A15.220
Only strobe #2 fails	A15.230
Only strobe #3 fails	A15.240
Only strobe #4 fails	A15.250
Only strobe #5 fails	A15.260
Only strobe #6 fails	A15.270
Only strobe #7 fails	A15.280
All other strobe failures	A15.8500

Warning



When the instrument is connected to ac line power or the A18 high voltage neon indicator is on, there are voltages present that can cause personal injury or death. Only trained, qualified personnel, who are aware of the hazards involved, should perform service on this instrument with its protective covers removed.

A15.210 Perform the following setup:

1. Set the line power switch to STANDBY.
2. Disconnect the line power cord.
3. Wait for all the indicators in the power supply section to go out.
4. Remove the rear panel and disconnect W31 (the ribbon cable that connects the motherboard to A19.) (Refer to the disassembly procedures as needed.)
5. Temporarily replace the rear panel, leaving the ribbon cable loose. Take great care to ensure that the ribbon cable is not in contact with any line power wires or connections.
6. Reconnect the line power cord.
7. Set the line power switch to ON.
8. Press **PRESET** **SERVICE**.
9. Select **Selftest Menu**.
10. Press **231** **ENTER**.
11. Select **Do Test #232**.

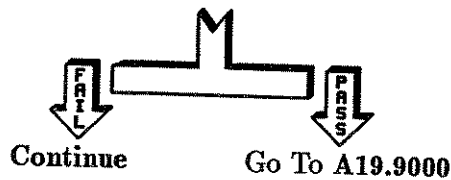

A15.211 Perform the following setup:

1. Set the line power switch to STANDBY.
2. Disconnect the line power cord.
3. Wait for all the indicators in the power supply section to go out.
4. Reconnect W31 (the ribbon cable that connects A19 to the motherboard.)

Go to A15.8500.

A15.220 Perform the following:

1. Set the line power switch to STANDBY.
2. Remove the A14 assembly.
3. Set the line power switch to ON.
4. Press **PRESET** **SERVICE**.
5. Select **Selftest Menu**.
6. Press **232** **ENTER**.
7. Select **Do Test #232**.

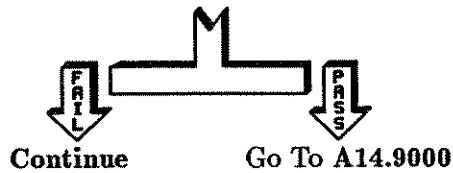

A15.221 Perform the following:

1. Set the line power switch to STANDBY.
 2. Replace the A14 assembly.
- Go to A15.8500.

A15.230 Perform the following:

1. Set the line power switch to STANDBY.
2. Remove the A11 and A12 assemblies.
3. Set line power switch to ON.
4. Press **PRESET** **SERVICE**.
5. Select **Selftest Menu**.
6. Press **232** **ENTER**.
7. Select **Do Test #232**.

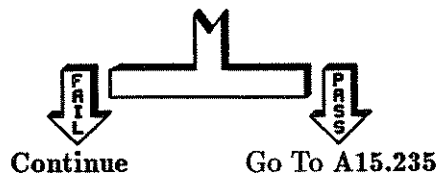

A15.231 Perform the following:

1. Set the line power switch to STANDBY.
2. Replace the A11 and A12 assemblies.

Go to A15.8500.

A15.235 Perform the following:

1. Set the line power switch to STANDBY.
2. Replace the A11 assembly.
3. Set the line power switch to ON.
4. Press **PRESET SERVICE**.
5. Select **Selftest Menu**.
6. Press **232 ENTER**.
7. Select **Do Test #232**.



Go To A11.9000 Go To A12.9000

A15.240 Perform the following:

1. Set the line power switch to STANDBY.
2. Remove the A9 and A10 assemblies.
3. Set the line power switch to ON.
4. Press **PRESET SERVICE**.
5. Select **Selftest Menu**.
6. Press **232 ENTER**.
7. Select **Do Test #232**.



Continue Go To A15.245

A15.241 Perform the following:

1. Set the line power switch to STANDBY.
2. Replace the A9 and A10 assemblies.

Go to A15.8500.

A15.245 Perform the following:

1. Set the line power switch to STANDBY.
2. Replace the A9 assembly.
3. Set the line power switch to ON.
4. Press **PRESET** **SERVICE**.
5. Select **Selftest Menu**.
6. Press **232** **ENTER**.
7. Select **Do Test #232**.

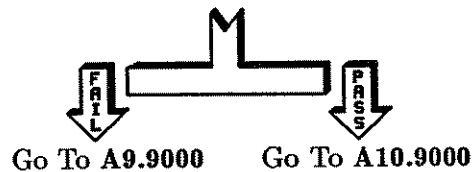

A15.250 Perform the following:

1. Set the line power switch to STANDBY.
2. Remove the A7 assembly.
3. Carefully remove the A6 assembly. Be sure to disconnect all cables.
4. Set the line power switch to ON.
5. Press **PRESET** **SERVICE**.
6. Select **Selftest Menu**.
7. Press **232** **ENTER**.

8. Select **Do Test #232**.

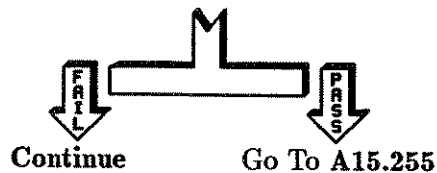

- A15.251** Perform the following:

1. Set the line power switch to STANDBY.
2. Replace the A6 and A7 assemblies.

Go To A15.8500.

- A15.255** Perform the following:

1. Set the line power switch to STANDBY.
2. Replace the A7 assembly.
3. Set the line power switch to ON.
4. Press **PRESET** **SERVICE**.
5. Select **Selftest Menu**.
6. Press **232** **ENTER**.
7. Select **Do Test #232**.

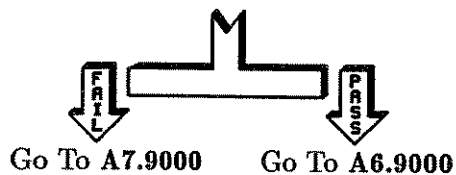

- A15.260** Perform the following:

1. Set the line power switch to STANDBY.
2. Remove the A4 and A5 assemblies.
3. Set the line power switch to ON.
4. Press **PRESET** **SERVICE**.
5. Select **Selftest Menu**.

6. Press **232** **ENTER**.
7. Select **Do Test #232**.

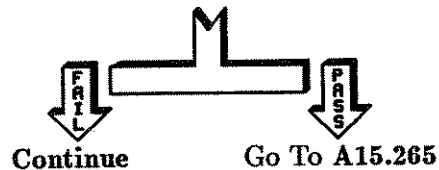

A15.261 Perform the following:

1. Set the line power switch to STANDBY.
 2. Replace the A4 and A5 assemblies.
- Go To A15.8500.

A15.265 Perform the following:

1. Set the line power switch to STANDBY.
2. Replace the A4 assembly.
3. Set the line power switch to ON.
4. Press **PRESET** **SERVICE**.
5. Select **Selftest Menu**.
6. Press **232** **ENTER**.
7. Select **Do Test #232**.

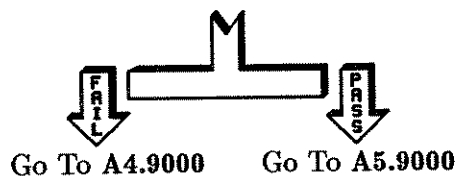

A15.270 Perform the following:

1. Set the line power switch to STANDBY.
2. Using the disassembly instructions, carefully remove the RF deck.
3. Set the line power switch to ON.
4. Press **PRESET** **SERVICE**.

5. Select **Selftest Menu**.
6. Press **232** **ENTER**.
7. Select **Do Test #232**.

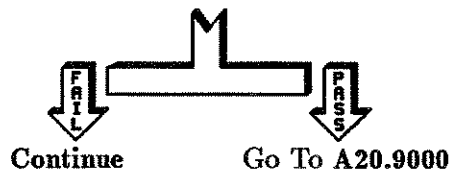

A15.271 Perform the following:

1. Set the line power switch to STANDBY.
2. Replace the A20 assembly.

Go To A15.8500.

A15.280 Perform the following setup:

1. Set the line power switch to STANDBY.
2. Disconnect the line power cord.
3. Wait for all the indicators in the power supply section to go out.
4. Remove the front panel and disconnect W2 and W3 (the ribbon cables connecting A2 and A3 to the motherboard.) Refer to the disassembly procedures as needed.
5. Temporarily replace the front panel leaving the ribbon cables loose.
6. Reconnect line power (the power-on control is on A2 so the synthesizer will power up automatically, even in standby).
7. Observe the red indicators on A15.

Are all A15 indicators off?

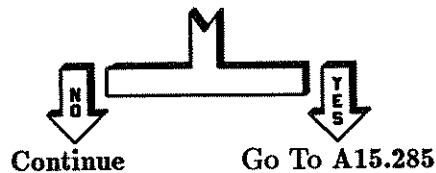

A15.281 Perform the following:

1. Set the line power switch to STANDBY.
2. Reconnect the ribbon cables for A2 and A3.

Go To A15.8500.

A15.285 Perform the following:

1. Set the line power switch to STANDBY.
2. Disconnect the line power cord.
3. Wait for all the indicators in the power supply section to go out.
4. Reconnect W3, the ribbon cable that connects the motherboard to A3.
5. Temporarily replace the front panel.
6. Reconnect the line power cord.
7. Press **PRESET** **SERVICE**.
8. Select **Selftest Menu**.
9. Press **232** **ENTER**.
10. Select **Do Test #232**.

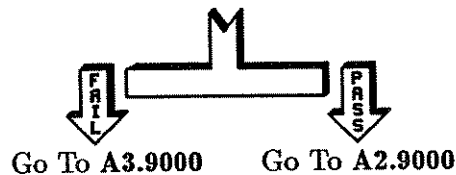

A15.300 Perform the following setup:

1. Set the line power switch to STANDBY.
2. Remove the following assemblies:
 - A4 fractional-n.
 - A5 YO loop.
 - A7 reference.
 - A9 pulse.
 - A10 ALC.
 - A11 FM driver.
 - A12 SYTM driver.
 - A13 YO driver.
 - A14 sweep generator.
3. Set the line power switch to ON.
4. Press **PRESET** **SERVICE**.
5. Select **Selftest Menu**.
6. Press **233** **ENTER**.
7. Select **Do Test #233**.



A15.301 Perform the following:

1. Set the line power switch to STANDBY.
2. Replace all of the assemblies removed in the previous step.
3. Carefully remove the A6 assembly. Be sure to disconnect all flexible and semi-rigid coax cables before removing A6.
4. Set the line power switch to ON.
5. Press **PRESET** **SERVICE**.
6. Select **Selftest Menu**.
7. Press **233** **ENTER**.

8. Select **Do Test #233**.

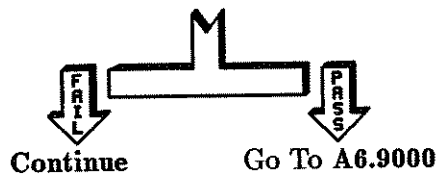

A15.302 Perform the following setup:

1. Set the line power switch to STANDBY.
2. Disconnect the line power cord.
3. Wait for all the indicators in the power supply section to go out.
4. Replace the A6 assembly removed in the previous step.
5. Remove the front panel and disconnect W2 (the ribbon cable that connects the motherboard to A2.) Refer to the disassembly procedures as needed.
6. Temporarily replace the front panel leaving W2 loose.
7. Reconnect line power (the power-on control is on A2 so the synthesizer will power up automatically, even in standby).
8. Press **PRESET** **SERVICE**.
9. Select **Selftest Menu**.
10. Press **233** **ENTER**.
11. Select **Do Test #233**.

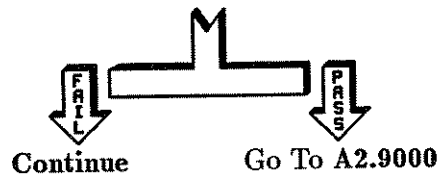

A15.303 Perform the following setup:

1. Disconnect the line power cord.
2. Wait for all the indicators in the power supply section to go out.
3. Remove the front panel.
4. Reconnect W2 to A2. Disconnect W3 (the ribbon cable that connects A3 to the motherboard.)
5. Temporarily replace the front panel, leaving W3 loose.
6. Reconnect line power.
7. Set the line power switch to ON.
8. Observe the red indicators on A15.

Are all A15 indicators off?

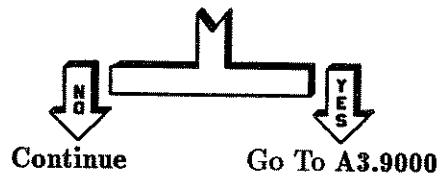

Warning



When the instrument is connected to ac line power or the A18 high voltage neon indicator is on, there are voltages present that can cause personal injury or death. Only trained, qualified personnel, who are aware of the hazards involved, should perform service on this instrument with its protective covers removed.

A15.304 Perform the following setup:

1. Set the line power switch to STANDBY.
2. Disconnect the line power cord.
3. Wait for all the indicators in the power supply section to go out.
4. Remove the front panel and reconnect W3 (the ribbon cable that connects A3 to the motherboard.)
5. Replace the front panel.

6. Remove the rear panel and disconnect W31 (the ribbon cable that connects the motherboard to A19.) Refer to the disassembly procedures as needed.
7. Temporarily replace the rear panel leaving W31 loose. Take great care to ensure the ribbon cable is not in contact with any line power wires or connections.
8. Reconnect line power.
9. Set the line power switch to ON.
10. Press **PRESET** **SERVICE**.
11. Select **Selftest Menu**.
12. Press **233** **ENTER**.
13. Select **Do Test #233**.

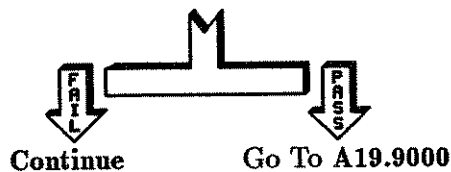

A15.305 Perform the following:

1. Set the line power switch to STANDBY.
2. Disconnect the line power cord.
3. Wait for all the indicators in the power supply section to go out.
4. Reconnect the A19 assembly removed in the previous step.
5. Remove the RF deck. Refer to the disassembly procedures as needed.
6. Reconnect line power.
7. Set the line power switch to ON.
8. Press **PRESET** **SERVICE**.
9. Select **Selftest Menu**.
10. Press **233** **ENTER**.

11. Select **Do Test #233**.



Go To A15.8500

Go To A20.9000

A15.320 One of the following assemblies is defective:

- A4 fractional-n.
- A5 YO loop.
- A7 reference.
- A9 pulse.
- A10 ALC.
- A11 FM driver.
- A12 SYTM driver.
- A13 YO driver.
- A14 sweep generator.

Replace any one of the assemblies and perform the following test:

1. Press **PRESET** **SERVICE**.
2. Select **Selftest Menu**.
3. Press **233** **ENTER**.
4. Select **Do Test #233**.

If the test fails, the assembly just replaced is defective. If the test does not fail, replace another assembly and repeat test number 233. When the defective assembly is identified, go to the 9000 paragraph for that assembly for replacement instructions. For example, for A4, go to A4.9000, for A5, go to A5.9000, and so on.

A15.400 Perform the following:

1. Set the line power switch to ON.
2. Press **PRESET** **SERVICE**.
3. Select **Selftest Menu**.
4. Press **234** **ENTER**.
5. Select **Log Output Menu** **When to Log Always** (asterisk on).
6. Press **PRIOR**.
7. Select **Do Test #234**.
8. Press **Continue**. Note the fail or pass status of the EEROM tests (ignore all other pass/fails).

Did all EEROM tests pass?

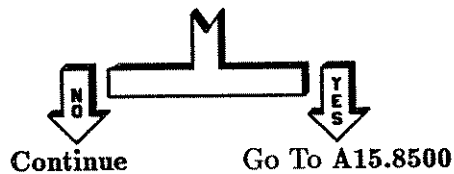

A15.401 Perform the following:

1. Set the line power switch to ON.
2. Press **PRESET** **SERVICE**.
3. Select **Selftest Menu**.
4. Press **235** **ENTER**.
5. Select **Do Test #235**.

Did all RAM tests pass?

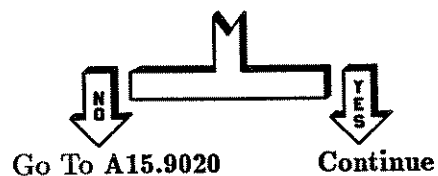

A15.405 Perform the following:

Note



Take great care during these procedures not to short out the battery for the battery backed-up RAM.

1. Set the line power switch to STANDBY.
2. Disconnect the line power cord.
3. Very carefully remove the A15 assembly and place it on an ESD mat.
4. Using plastic tools and taking great care not to short out the battery backed-up RAM, remove and replace the EEROM (U4) on A15 with a new EEROM.
5. Reinstall A15.
6. Reconnect line power.
7. Set the line power switch to ON.
8. Press **PRESET** **SERVICE**.
9. Select **Adjust Menu** **Calib Menu** **Cal Util Menu**.
10. Select **Save Cal** **yes**.

Were you able to save calibration constants from RAM to EEROM successfully?



Go To A15.9020

Continue

A15.406 Perform the following:

1. Press **PRESET** **SERVICE**.
2. Select **Selftest (Full)**.

Do all tests pass?

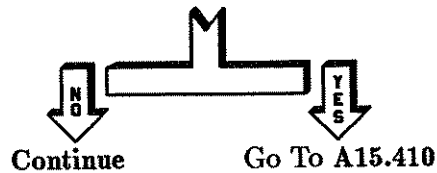

A15.407 The synthesizer indicates one or more self-test failures. Go to the paragraph shown on the synthesizer for the failure *unless* the message is A15 : ROM tests. In that case, rather than the paragraph shown on the synthesizer, go to A15.9020.

A15.410 When EEROM was lost, most of the calibration data was saved by copying from battery backed-up RAM. However, two types of data were not saved. These data were test patches for the diagnostics and attenuator correction data. Both sets of data will have to be recreated.

To recreate the attenuator correction data, refer to the performance tests and adjustments. For the test patches on the diagnostics, refer to the appropriate service or installation notes.

A15.500 When the HP-IB diagnostic was performed, was the HP 8360 series synthesizer disconnected from all HP-IB busses?

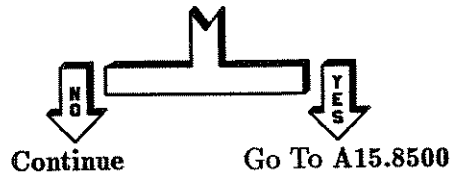

A15.501 Remove all HP-IB connections and restart the troubleshooting process.

A15.1100 Perform the following setup:

1. Set the line power switch to STANDBY.
2. Completely remove the following assemblies:
 - A4 fractional-n.
 - A5 YO loop.
 - A7 reference.
 - A9 pulse.
 - A10 ALC.
 - A11 FM driver.
 - A12 SYTM driver.
 - A13 YO driver.
 - A14 sweep generator.
3. Repeat the power-on sequence and observe the indicators on A15.

Did all the indicators turn on temporarily and then turn off?

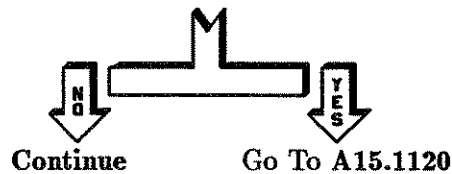

A15.1101 Perform the following setup:

1. Set the line power switch to STANDBY.
2. Replace all of the assemblies removed in the previous step and reconnect all cables.
3. Carefully remove the A6 assembly. Be sure to disconnect all flexible and semi-rigid coax cables before removing A6.
4. Repeat the power-on sequence and observe the indicators on A15.

Did all the indicators turn on temporarily and then turn off?

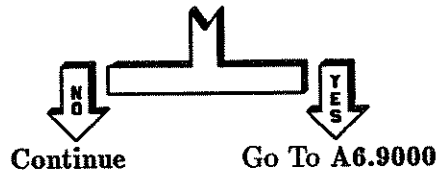

A15.1102 Perform the following setup:

1. Set the line power switch to STANDBY.
2. Disconnect the line power cord.
3. Wait for all the indicators in the power supply section to go out.
4. Replace the A6 assembly (removed in the previous step) and reconnect all cables.
5. Using the disassembly instructions, remove the front panel and disconnect W2 (the ribbon cable that connects the motherboard to A2.)
6. Temporarily replace the front panel leaving W2 loose.
7. Reconnect line power (the power-on control is on A2 so the synthesizer will power up automatically, even in standby) and observe the indicators on A15.

Did all the indicators turn on temporarily and then turn off?

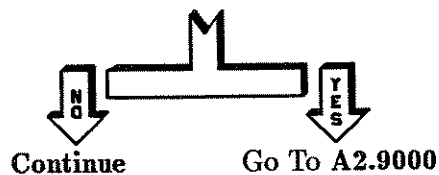

A15.1103 Perform the following setup:

1. Disconnect the line power cord.
2. Wait for all the indicators in the power supply section to go out.
3. Remove the front panel.
4. Reconnect W2 to A2.

5. Disconnect W3 (the ribbon cable that connects A3 to the motherboard.)
6. Temporarily replace the front panel leaving the ribbon cable loose.
7. Reconnect the line power cord.
8. Repeat the power-on sequence and observe the indicators on A15.

Did all the indicators turn on temporarily and then turn off?

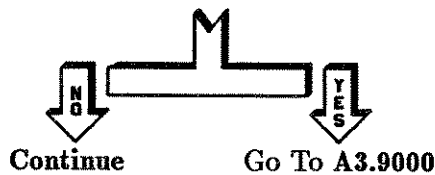

Warning



When the instrument is connected to ac line power or the A18 high voltage neon indicator is on, there are voltages present that can cause personal injury or death. Only trained, qualified personnel, who are aware of the hazards involved, should perform service on this instrument with its protective covers removed.

A15.1104

Perform the following setup:

1. Set the line power switch to STANDBY.
2. Disconnect the line power cord.
3. Wait for all the indicators in the power supply section to go out.
4. Remove the front panel and reconnect W3 (the ribbon cable that connects A3 to the motherboard.)
5. Replace the front panel.
6. Remove the rear panel and disconnect W31 (the ribbon cable that connects the motherboard to A19.) Refer to the disassembly procedures as needed.
7. Temporarily replace the rear panel leaving the ribbon cable loose. Take great care to ensure the ribbon

cable is not in contact with any line power wires or connections.

8. Reconnect the line power cord.
9. Repeat the power-on sequence and observe the indicators on A15.

Did all the indicators turn on temporarily and then turn off?

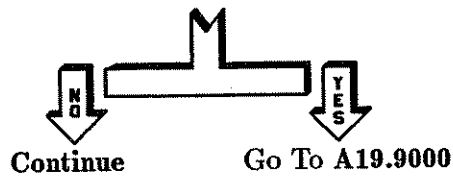

A15.1105 Perform the following setup:

1. Set the line power switch to STANDBY.
2. Disconnect the line power cord.
3. Wait for all the indicators in the power supply section to go out.
4. Reconnect W31 (the ribbon cable that connects A19 to the motherboard.)
5. Remove the RF deck. Refer to the disassembly procedures as needed.
6. Reconnect the line power cord.
7. Repeat the power-on sequence and observe the indicators on A15.

Did all the indicators turn on temporarily and then turn off?

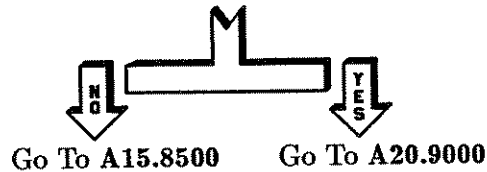

A15.1120 One of the following assemblies is defective:

- A4 fractional-n.
- A5 YO loop.
- A7 reference.
- A9 pulse.
- A10 ALC.
- A11 FM driver.
- A12 SYTM driver.
- A13 YO driver.
- A14 sweep generator.

1. Set the line power switch to STANDBY.
2. Replace an assembly.
3. Set the line power switch to ON.
4. Check the display's operation. If the display or the indicators on A15 begin to operate incorrectly, the assembly just replaced is defective. If the display does not fail, replace another assembly and repeat the process. When the defective assembly is identified, go to the 9000 paragraph for that assembly for replacement instructions. For example, for A4, go to A4.9000, for A5, go to A5.9000, and so on.

A15.1200 Perform the following setup:

1. Set the line power switch to ON and observe the 12 LEDs on the top edge of A15.
2. When the 4 left-most LEDs (DS1) display 0010, observe and record the state of the right 8 LEDs (DS2 and DS3).

3. Find the state of the right 8 LEDs in the following table and go to the indicated paragraph.

LEDs	Go To Paragraph
X1XX XXXX	A15.1201
1XXX XXXX	A15.1201
11XX XXXX	A15.1201
All Else	A15.8500
X = don't care	

A15.1201 An EEROM failure has occurred. There is some chance that the EEROM data can be partially recovered from RAM. This test determines if any data might be recovered.

1. Set the line power switch to STANDBY and then set it to ON and observe the 12 LEDs on the top edge of A15.
2. When the 4 left-most LEDs (DS1) display 0010, observe and record the state of the right 8 LEDs (DS2 and DS3).
3. Find the state of the right 8 LEDs in the following table and go to the indicated paragraph.

LEDs	Go To Paragraph
X1XX XXXX	A15.1201
1XXX XXXX	A15.1201
11XX XXXX	A15.1201
All Else	A15.8500
X = don't care	

A15.1205 Perform the following:

Note



Take great care during these procedures not to short out the battery for the battery backed-up RAM.

1. Set the line power switch to STANDBY.
2. Disconnect the line power cord.
3. Very carefully remove the A15 assembly and place it on an ESD mat.
4. Using plastic tools and taking great care not to short out the battery backed-up RAM, remove the EEROM (U4) on A15 and install a new EEROM.
5. Reinstall A15.
6. Reconnect line power.
7. Set the line power switch to ON.
8. Press **PRESET** **SERVICE**.
9. Select **Adjust Menu** **Calib Menu** **Cal Util Menu**.
10. Select **Save Cal** **yes**.

Were you able to save calibration constants from RAM to EEROM successfully?



Go To A15.9020

Continue

A15.1206 Perform the following:

1. Press **PRESET** **SERVICE**.
2. Select **Selftest (Full)**.

Do all tests pass?

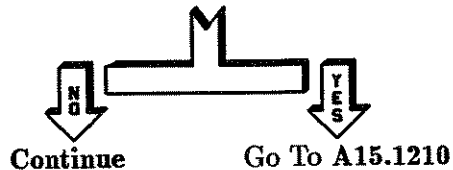

A15.1207 The synthesizer indicates one or more self-test failures. Go to the paragraph shown on the synthesizer for the failure *unless* the message is **A15 : ROM tests**. In that case, rather than the paragraph shown on the synthesizer, go to A15.9020.

A15.1210 When EEROM was lost, most of the calibration data was saved by copying from battery backed-up RAM. However, two types of data were not saved. These data were test patches for the diagnostics and attenuator correction data. Both sets of data will have to be recreated.

To recreate the attenuator correction data, refer to the performance tests and adjustments. For the test patches on the diagnostics, refer to the appropriate service or installation notes.

A15.1300 Perform the following setup:

1. Set the line power switch to ON and observe the 12 LEDs on the top edge of A15.
2. When the 4 left-most LEDs (DS1) display 0011, observe and record the state of the right 8 LEDs (DS2 and DS3).
3. Find the state of the right 8 LEDs in the following table and go to the indicated paragraph.

LEDs	Go To Paragraph
0000 0001	A15.1310
0000 0010	A15.1320
0000 0100	A15.1330
0000 1000	A15.1340
0001 0000	A15.1350
0010 0000	A15.1360
0100 0000	A15.1370
1000 0000	A15.1380
All Else	A15.8500

Warning



When the instrument is connected to ac line power or the A18 high voltage neon indicator is on, there are voltages present that can cause personal injury or death. Only trained, qualified personnel, who are aware of the hazards involved, should perform service on this instrument with its protective covers removed.

A15.1310 Perform the following setup:

1. Set the line power switch to STANDBY.
2. Disconnect the line power cord.
3. Wait for all the indicators in the power supply section to go out.
4. Remove the rear panel and disconnect W31 (the ribbon cable that connects the motherboard to A19.) Refer to the disassembly procedures as needed.
5. Temporarily replace the rear panel leaving the ribbon cable loose. Take great care to ensure the ribbon cable is not in contact with any line power wires or connections.
6. Reconnect the line power cord.
7. Repeat the power-on sequence and observe the indicators on A15.

Did all the indicators turn on temporarily and then turn off?

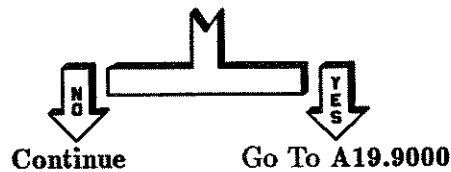

A15.1311 Perform the following setup:

1. Set the line power switch to STANDBY.
2. Disconnect the line power cord.
3. Wait for all the indicators in the power supply section to go out.
4. Reconnect W31 (the ribbon cable that connects A19 to the motherboard.)

Go to A15.8500.

A15.1320 Perform the following setup:

1. Set the line power switch to STANDBY.
2. Remove the A14 assembly.
3. Repeat the power-on sequence and observe the indicators on A15.

Did all the indicators turn on temporarily and then turn off?

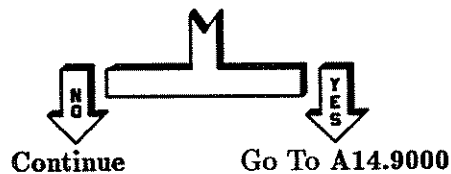

A15.1321 Perform the following:

1. Set the line power switch to STANDBY.
2. Replace the A14 assembly.

Go to A15.8500.

A15.1330 Perform the following setup:

1. Set the line power switch to STANDBY.
2. Remove the A11 and A12 assemblies.
3. Repeat the power-on sequence and observe the indicators on A15.

Did all the indicators turn on temporarily and then turn off?

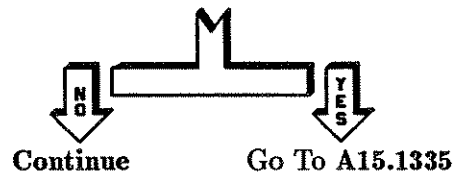

A15.1331 Perform the following:

1. Set the line power switch to STANDBY.
2. Replace the A11 and A12 assemblies.

Go to A15.8500.

A15.1335 Perform the following setup:

1. Set the line power switch to STANDBY.
2. Replace the A11 assembly.
3. Repeat the power-on sequence and observe the indicators on A15.

Did all the indicators turn on temporarily and then turn off?

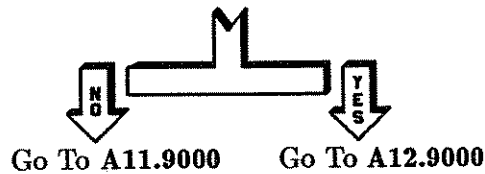

A15.1340 Perform the following setup:

1. Set the line power switch to STANDBY.
2. Remove the A9 and A10 assemblies.
3. Repeat the power-on sequence and observe the indicators on A15.

Did all the indicators turn on temporarily and then turn off?

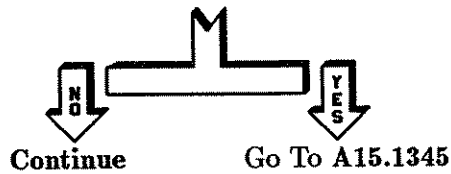

A15.1341 Perform the following:

1. Set the line power switch to STANDBY.
2. Replace the A9 and A10 assemblies.

Go to A15.8500.

A15.1345 Perform the following setup:

1. Set the line power switch to STANDBY.
2. Replace the A9 assembly.
3. Repeat the power-on sequence and observe the indicators on A15.

Did all the indicators turn on temporarily and then turn off?

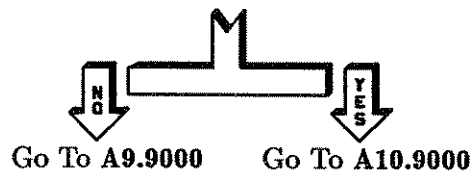

A15.1350 Perform the following setup:

1. Set the line power switch to STANDBY.
2. Remove the A7 assembly.
3. Carefully remove the A6 assembly. Be sure to disconnect all cables.
4. Repeat the power-on sequence and observe the indicators on A15.

Did all the indicators turn on temporarily and then turn off?

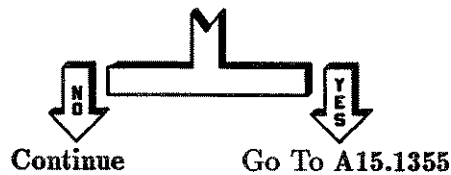

A15.1351 Perform the following:

1. Set the line power switch to STANDBY.
2. Replace the A6 and A7 assemblies.

Go To A15.8500.

A15.1355 Perform the following setup:

1. Set the line power switch to STANDBY.
2. Replace the A7 assembly.
3. Repeat the power-on sequence and observe the indicators on A15.

Did all the indicators turn on temporarily and then turn off?

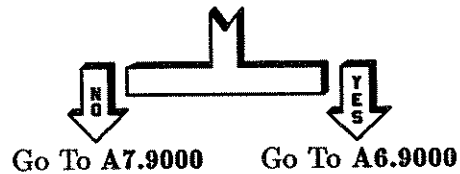

A15.1360 Perform the following setup:

1. Set the line power switch to STANDBY.
2. Remove the A4 and A5 assemblies.
3. Repeat the power-on sequence and observe the indicators on A15.

Did all the indicators turn on temporarily and then turn off?

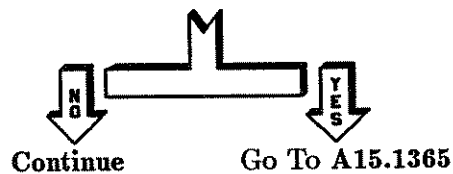

A15.1361 Perform the following:

1. Set the line power switch to STANDBY.
2. Replace the A4 and A5 assemblies.

Go To A15.8500

A15.1365 Perform the following setup:

1. Set the line power switch to STANDBY.
2. Replace the A4 assembly.
3. Repeat the power-on sequence and observe the indicators on A15.

Did all the indicators turn on temporarily and then turn off?

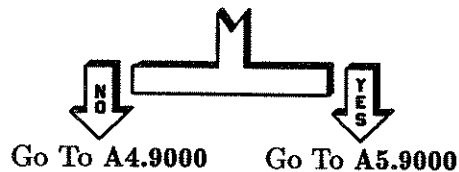

A15.1370 Perform the following setup:

1. Set the line power switch to STANDBY.
2. Using the disassembly instructions, carefully remove the RF deck (A20).
3. Repeat the power-on sequence and observe the indicators on A15.

Did all the indicators turn on temporarily and then turn off?

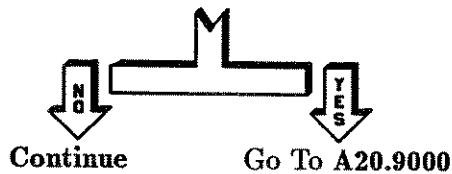

A15.1371 Perform the following:

1. Set the line power switch to STANDBY.
2. Replace the A20 assembly.

Go To A15.8500.

A15.1380 Perform the following setup:

1. Set the line power switch to STANDBY.
2. Disconnect the line power cord.
3. Wait for all the indicators in the power supply section to go out.
4. Remove the front panel and disconnect W2 and W3 (the ribbon cables connecting A2 and A3 to the

motherboard.) Refer to the disassembly procedures as needed.

5. Temporarily replace the front panel leaving the ribbon cables loose.
6. Reconnect line power (the power-on control is on A2 so the synthesizer will power up automatically, even in standby) and observe the indicators on A15.

Did all the indicators turn on temporarily and then turn off?

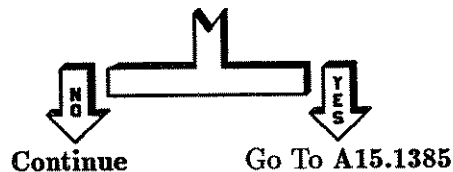

A15.1381 Perform the following:

1. Set the line power switch to STANDBY.
2. Reconnect the ribbon cables for A2 and A3.

Go To A15.8500.

A15.1385 Perform the following setup:

1. Set the line power switch to STANDBY.
2. Disconnect the line power cord.
3. Wait for all the indicators in the power supply section to go out.
4. Reconnect W3, the ribbon cable that connects the motherboard to A3.
5. Temporarily replace the front panel.
6. Reconnect the line power cord.
7. Repeat the power-on sequence and observe the indicators on A15.

Did all the indicators turn on temporarily and then turn off?

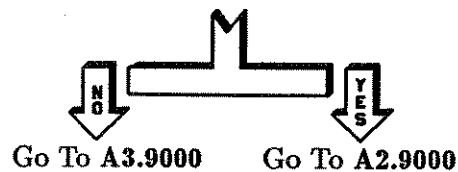

A15.1400 Perform the following setup:

1. Set the line power switch to STANDBY.
2. Completely remove the following assemblies:
 - A4 fractional-n.
 - A5 YO loop.
 - A7 reference.
 - A9 pulse.
 - A10 ALC.
 - A11 FM driver.
 - A12 SYTM driver.
 - A13 YO driver.
 - A14 sweep generator.
3. Repeat the power-on sequence and observe the indicators on A15.

Did all the indicators turn on temporarily and then turn off?

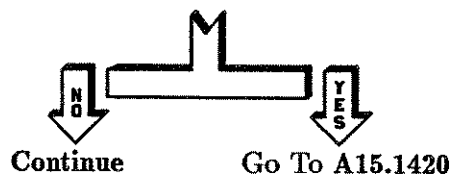

A15.1401 Perform the following setup:

1. Set the line power switch to STANDBY.
2. Replace all of the assemblies removed in the previous step and reconnect all cables.

3. Carefully remove the A6 assembly. Be sure to disconnect all flexible and semi-rigid coax cables before removing A6.
4. Repeat the power-on sequence and observe the indicators on A15.

Did all the indicators turn on temporarily and then turn off?

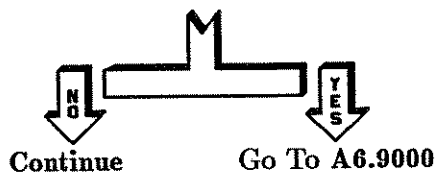

A15.1402 Perform the following setup:

1. Set the line power switch to STANDBY.
2. Disconnect the line power cord.
3. Wait for all the indicators in the power supply section to go out.
4. Replace the A6 assembly (removed in the previous step) and reconnect all cables.
5. Using the disassembly instructions, remove the front panel and disconnect W2 (the ribbon cable that connects the motherboard to A2.)
6. Temporarily replace the front panel leaving the ribbon cable loose.
7. Reconnect line power (the power-on control is on A2 so the synthesizer will power up automatically, even in standby) and observe the indicators on A15.

Did all the indicators turn on temporarily and then turn off?

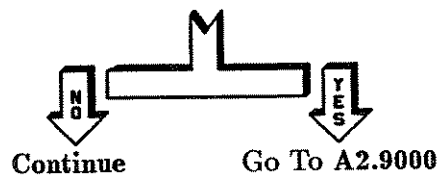

A15.1403 Perform the following setup:

1. Disconnect the line power cord.
2. Wait for all the indicators in the power supply section to go out.
3. Remove the front panel.
4. Reconnect W2 to A2.
5. Disconnect W3 (the ribbon cable that connects A3 to the motherboard.)
6. Temporarily replace the front panel leaving the ribbon cable loose.
7. Reconnect the line power cord.
8. Repeat the power-on sequence and observe the indicators on A15.

Did all the indicators turn on temporarily and then turn off?



Warning



When the instrument is connected to ac line power or the A18 high voltage neon indicator is on, there are voltages present that can cause personal injury or death. Only trained, qualified personnel, who are aware of the hazards involved, should perform service on this instrument with its protective covers removed.

A15.1404 Perform the following setup:

1. Set the line power switch to STANDBY.
2. Disconnect the line power cord.
3. Wait for all the indicators in the power supply section to go out.
4. Remove the front panel and reconnect W3 (the ribbon cable that connects A3 to the motherboard.)

5. Replace the front panel.
6. Remove the rear panel and disconnect W31 (the ribbon cable that connects the motherboard to A19.) Refer to the disassembly procedures as needed.
7. Temporarily replace the rear panel leaving the ribbon cable loose. Take great care to ensure the ribbon cable is not in contact with any line power wires or connections.
8. Reconnect the line power cord.
9. Repeat the power-on sequence and observe the indicators on A15.

Did all the indicators turn on temporarily and then turn off?

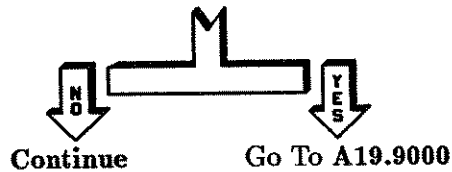

A15.1405 Perform the following setup:

1. Set the line power switch to STANDBY.
2. Disconnect the line power cord.
3. Wait for all the indicators in the power supply section to go out.
4. Reconnect W31 (the ribbon cable that connects A19 to the motherboard.)
5. Remove the RF deck. Refer to the disassembly procedures as needed.
6. Reconnect the line power cord.
7. Repeat the power-on sequence and observe the indicators on A15.

Did all the indicators turn on temporarily and then turn off?

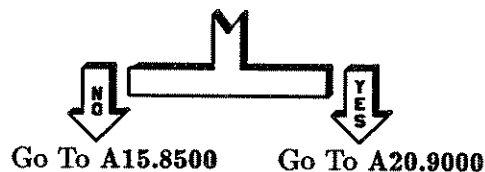

A15.1420 One of the following assemblies is defective:

- A4 fractional-n.
- A5 YO loop.
- A7 reference.
- A9 pulse.
- A10 ALC.
- A11 FM driver.
- A12 SYTM driver.
- A13 YO driver.
- A14 sweep generator.

Replace the assemblies one at a time. Then check the display's operation. If the display begins to operate incorrectly, the assembly just replaced is defective. If the test does not fail, replace another assembly and repeat the process. When the defective assembly is identified, go to the 9000 paragraph for that assembly for replacement instructions. For example, for A4, go to A4.9000, for A5, go to A5.9000, and so on.

A15.8500 Perform the following:

1. Set the line power switch to STANDBY.
2. Replace any remaining assemblies that had been removed.
3. Remove and replace A15 (this resets the edge connector).
4. Set the line power switch to ON.
5. Press **PRESET** **SERVICE**.
6. Select **Selftest Menu**.

7. Press **228** **ENTER**.
8. Press **Do Test #228**.

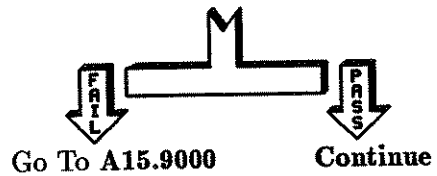

A15.8501

Removing and replacing A15 has apparently fixed the problem. Most likely, it was an intermittent problem associated with the edge connector or IC sockets on A15. Record this situation for future reference. If the problem recurs, or if this is a recurrence, then replace A15 (go to A15.9000). Otherwise you are done.

A15.9000

Perform the following:

1. Set the line power switch to STANDBY.
2. Remove the A15 assembly.
3. Install a new A15 assembly.
4. Set the line power switch to ON.
5. Press **PRESET** **SERVICE**.
6. Select **Selftest Menu**.
7. Press **228** **ENTER**.
8. Press **Do Test #228**.

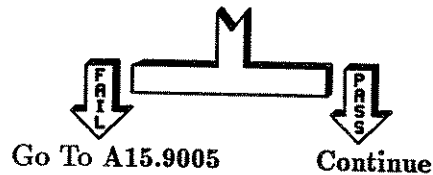

A15.9001

The calibration data stored in RAM and EEROM on the failed A15 assembly appears intact. The following procedure retains the calibration data by transferring the EEROMs to the new A15 assembly. However, the replacement of the EEROMs on A15 is somewhat complex. Do not rush through this procedure. A single error could cause you to lose all the calibration data. This data requires several days to recreate. Carefully follow these steps:

1. Set the line power switch to STANDBY.
2. Remove the line power cord.
3. Very carefully remove the defective A15 assembly and place it on an ESD mat.
4. Using appropriate tools, and taking great care not to damage the EEROM (U14), remove the EEROM from the defective A15 assembly and install the EEROM (U14) on the new A15 assembly.
5. Install the new A15 assembly in the instrument.
6. Reconnect line power.

7. Set the line power switch to ON.
8. Press **PRESET** **SERVICE**.
9. Select **Adjust Menu** **Calib Menu** **Cal Util Menu**
Recall Cal **yes**.
10. Select **Selftest Menu**.
11. Press **228** **ENTER**.
12. Press **Do Test #228**.



Go To A15.9020

Continue

A15.9002 To retain traceability, perform the ADC Adjustment using the automated tests software supplied with the synthesizer. An HP 9000 series 200/300 desktop computer and HP BASIC are required in addition to the software. Follow the procedure given in "Automated Tests" in the *Service* manual. After completing the adjustment, go to the Troubleshooting Foldout, block 1 (located just prior to the "Special Cases" tab).

A15.9005 This new A15 assembly is defective also. Remove this A15 assembly and reinstall the original (defective) A15 assembly. You must have the original A15 assembly because it contains all the calibration data for the instrument. Go to A15.9000 and replace A15 again. If the new A15 is not defective, you will be instructed to transfer the calibration data to that assembly.

A15.9020 You have lost both EEROM and battery backed-up RAM. This means that all hardware configuration data and all firmware correction are lost. Before the instrument will perform properly you must complete the following steps in the order given.

1. Replace the A15 assembly.
2. Install any firmware diagnostic patches as required (the installation instructions for A15 should indicate which patches are required and how to install them).
3. Using the instrument level troubleshooting (ILT.000), run the diagnostics to isolate any additional problems.
4. Recreate the hardware configuration data (you will need to contact Hewlett Packard for instructions or assistance).
5. Run the diagnostics and solve any additional problems as required.
6. Recreate all the calibration data (use the performance tests and adjustments).

A16, A17, A18 Power Supply Troubleshooting

Warning



When the instrument is connected to ac line power or the A18 high voltage neon indicator is on, there are voltages present that can cause personal injury or death. Only trained, qualified personnel, who are aware of the hazards involved, should perform service on this instrument with its protective covers removed. An isolation transformer must be used during all these procedures.

Observe all safety practices. Remove all jewelry/metal that can short to ground.

A16.000

Troubleshooting power supplies is dangerous. Be extra cautious. Perform a complete visual inspection of the instrument and resolve any safety issues as required.

Continue to A16.100.

A16.100 Do the following:

1. Set the line power switch to STANDBY.
2. Disconnect the ac line power cord.
3. Remove the instrument's top cover.
4. Wait for all the indicators in the power supply section to go out.
5. Completely remove the following assemblies:
 - A16 post regulator.
 - A17 rectifier and filter.
 - A18 switching regulator.
6. Inspect the line fuse on the rear of the instrument. Replace it, if necessary.
7. Connect the instrument to ac line power using an isolation transformer. Do not turn the instrument on.
8. Listen and watch. The instrument should remain inactive.
9. Disconnect the ac line power cord.
10. Inspect the line fuse (it should be undamaged).

Does the instrument remain inactive and is the line fuse undamaged?

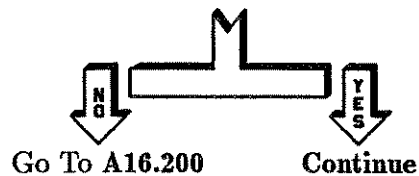

A16.101 Inspect A17 and A18 for signs of physical damage. On the A18 assembly, look closely at the large resistors underneath and adjacent to the large heat sinks on A18. Check the fuses on A17 and A18 (one each). If they are open replace them. Then, using the following table, go to the indicated paragraph.

Either Fuse Open?	Either A17 or A18 Damaged?	Go To Paragraph
Yes	Yes	A16.321
Yes	No	A16.321
No	Yes	A16.206
No	No	A16.102

A16.102 Continue with the following setup:

1. With ac line power *disconnected*, install A17 and A18.
2. Connect the instrument to ac line power using an isolation transformer. Do not turn the instrument on.
3. Observe the indicators on A18 and the amber standby light on the front panel of the instrument. Compare their status to the following list:
 - Amber standby light (front panel) – ON.
 - A18 neon high voltage indicator (DS2) – ON.
 - A18 green +13.6V LED (DS1) – ON.
 - A18 amber preregulator shutdown LED (DS7) – ON.
 - All other A18 LEDs – OFF.

Were all indicators correct and does the instrument still appear safe to operate?

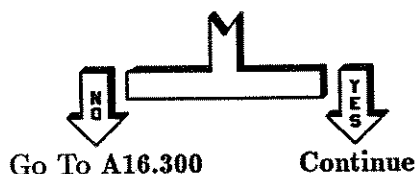

- A16.103**
1. Turn the instrument ON and make the following observations *during* power up.
 - Amber standby light (front panel) – OFF.
 - Green power-on light (front panel) – ON.
 - A18 neon high voltage indicator (DS2) – ON.
 - A18 green +13.6V LED (DS1) – ON.
 - A18 amber preregulator shutdown LED (DS7) – OFF.
 - All other A18 LEDs – OFF.
 2. Turn the instrument to STANDBY.

Were all indicators correct and does the instrument still appear safe to operate?

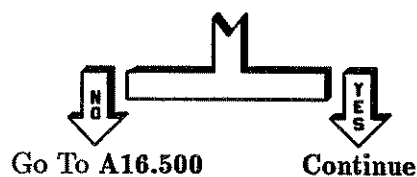

- A16.104**
1. Verify that the line switch is in STANDBY.
 2. Disconnect the ac line power cord.
 3. Wait for all the indicators in the power supply section to go out.
 4. Install A16.
 5. Reconnect ac line power through an isolation transformer.
 6. Observe the amber standby light and the green power-on light on the front panel of the instrument. Also check the indicators on A16 and A18. Compare their status to the following list:
 - Amber standby light – ON.
 - Green power-on light – OFF.
 - A18 neon high voltage indicator (DS2) – ON.
 - A18 green +13.6V LED (DS1) – ON.
 - A18 amber preregulator shutdown LED (DS7) – ON.
 - Other A18 LEDs – OFF.
 - A16 green +22V standby LED – ON.

- Other A16 LEDs – OFF.

Were all indicators correct and does the instrument still appear safe to operate?

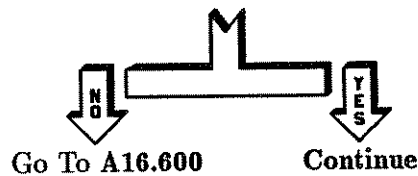

A16.105

1. Turn the line power switch to ON and make the following observations *during* power up:
 - Amber standby light – OFF (front panel).
 - Green power-on light – ON (front panel).
 - A18 neon high voltage indicator (DS2) – ON.
 - A18 green +13.6V LED (DS1) – ON.
 - A18 amber preregulator shutdown LED (DS7) – OFF.
 - All other A18 LEDs – OFF.
 - A16 green LEDs (from left to right, component side or from right to left when facing the front of the instrument):
 - +22V STBY – ON.
 - +5V – ON.
 - +8V – ON.
 - +15V – ON.
 - +5VHD – ON.
 - 5V – ON.
 - 15V – ON.
 - 40V – ON.
 - A16 red LEDs – OFF.
 - The fan is operating.
2. Ignore any activity on the front panel display.
3. Turn the line power switch OFF.

Were all the indicators correct and does the instrument appear safe to operate?

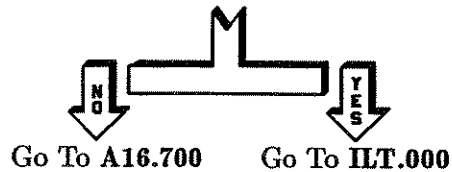

A16.200

Do the following:

1. Disconnect the ac line power cord.
2. Wait for all the indicators in the power supply section to go out.
3. Remove the rear panel completely (refer to the disassembly and replacement procedures as required).
4. Disconnect and inspect the 8-pin line switch connector, ac voltage selection switch, line module, fuse holder and other attached hardware for damage or discoloration.
5. Inspect the motherboard.

Do the parts appear damaged?

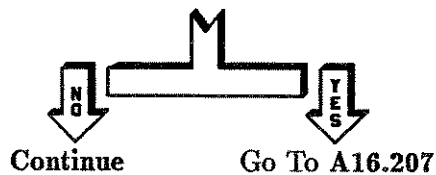

A16.201

Measure the resistance of the three line power connections (high, low and ground) with reference to the instrument chassis. High line and low line resistance to ground should be $\geq 1\text{ M}\Omega$. The ground connection resistance to instrument chassis should be $\leq 0.1\Omega$.

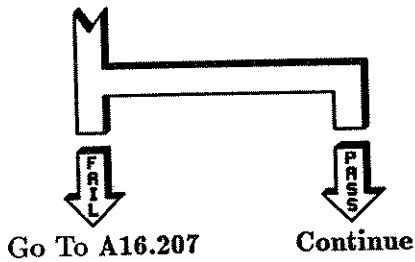
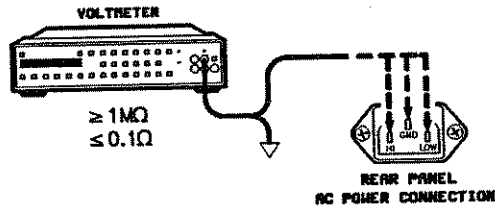

A16.202

Measure the resistance between high line and low line.

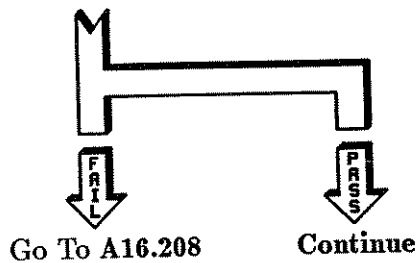
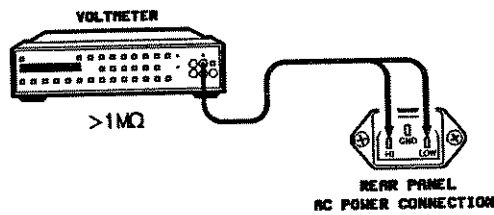

A16.203 Reconnect the rear panel, 8-pin line switch connector to the motherboard (A22J9). Measure the resistance between high line and low line.

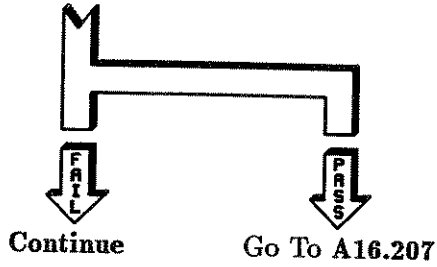
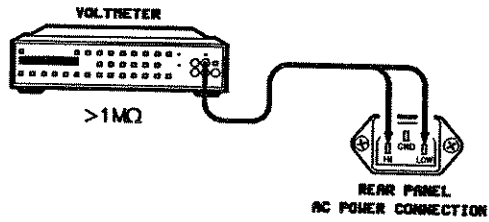

A16.204

Warning



Direct connections to line voltages will be exposed during this and subsequent steps. Ensure that line power is completely removed.

Ensure that all power is disconnected and all capacitors are discharged. Remove the small red cover (high voltage cover) at the bottom rear of the instrument. The cover is held in place with three screws. Two screws are located on either side of XA18J1 (A18 motherboard connector) and are accessed from the top of the motherboard. The third screw is located at the rear edge of the motherboard. You may have to remove the rear panel to access this third screw. Inspect the line power traces on the motherboard. Look for signs of shorting, discoloration, or other signs of damage. Are any of the line power traces on the motherboard damaged?

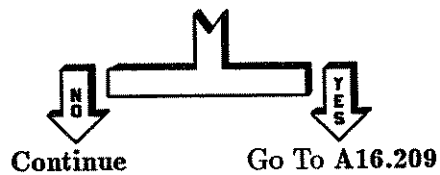

A16.205 Inspect A17 and A18. Check for signs of physical damage. On the A18 assembly, look closely at the large resistors underneath and adjacent to the large heat sinks on A18. Check the fuses on A17 and A18 (one each). If they are open replace them. Do A17 and A18 appear damaged?

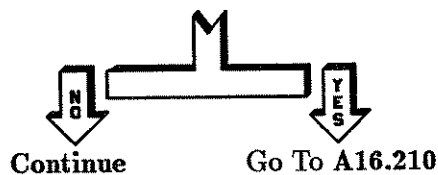

A16.206 If the problem was open fuses on either A17 or A18, it is unlikely that replacing the fuses will solve the problem completely. Typically, open fuses are an indication of other failures. However, you may want to replace the fuses and restart troubleshooting at A16.000. Otherwise, do the following:

Replace the following:

1. AC voltage selection switch/wiring harness.
2. FL1 line module-filtered.
3. Fuse and fuse holder.
4. Other line-related hardware that shows any amount of damage.

Inspect and replace, if damaged, the following:

1. A17 rectifier/filter.
2. A18 switching regulator.
3. A16 post regulator.
4. A22 motherboard (inspect A22 closely before replacing).

See the disassembly instructions and replaceable parts information as necessary. Restart troubleshooting at A16.0000.

A16.207 Replace the following:

- FL1, line module - filtered.
- AC voltage selection switch/wiring harness.
- Fuse and fuse holder.
- Any other damaged or discolored parts or assemblies.
- Replace the motherboard if damaged.

Restart troubleshooting at A16.000.

A16.208 Replace FL1, line module - filtered and ac voltage selection switch/wiring harness and then restart troubleshooting at A16.000.

A16.209 The A22 motherboard has a defect in the traces carrying line power. Do not attempt to repair A22. Replace A22 (go to A22.9000). Inspect A17 and A18. Check for signs of physical damage. On the A18 assembly, look closely at the large resistors underneath and adjacent to the large heat sinks on A18. Check the fuses on A17 and A18 (one each). If they are open, replace them. Restart troubleshooting with A16.000.

A16.210 Do not attempt to repair either assembly. Replace A17 and A18 as required. Reassemble the instrument and restart troubleshooting from the beginning of instrument level troubleshooting. If you have already taken this action, refer to A16.206 for additional information.

A16.300 Are any A18 indicators on?

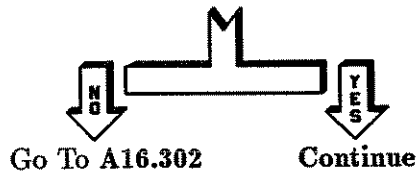

A16.301 Select the first correct condition and go to the indicated paragraph.

Neon HIGH VLT	Green +13.6V	Amber PRERGSHTDWN	Go To Paragraph
OFF	-	-	A18.9000
ON	OFF	-	A16.320
ON	ON	OFF	A16.360
ON	ON	ON	A16.380

A dash (-) indicates a don't care condition.

A16.302 Set the line power switch to STANDBY. Disconnect the ac line cord and check the line fuse.

Is the line fuse good?

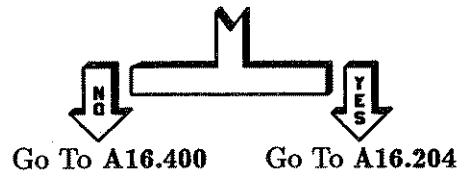

A16.320 Do the following:

1. Disconnect the instrument from line power.
2. Wait for all the indicators in the power supply section to go out.
3. Carefully remove A18 and discharge all the large capacitors.
4. Check the fuse on A18 (A18F1).

Is A18F1 good?

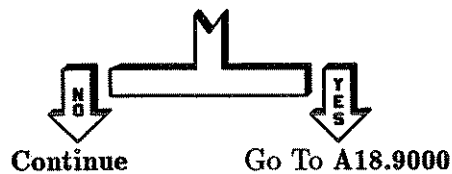

A16.321 Reinstall A16. Then measure the resistance of XA16J1-36 to ground.

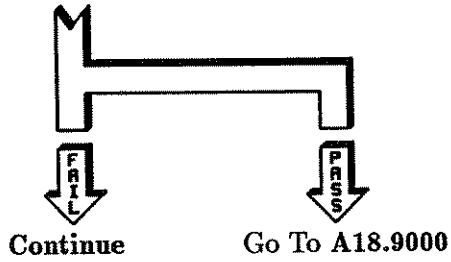
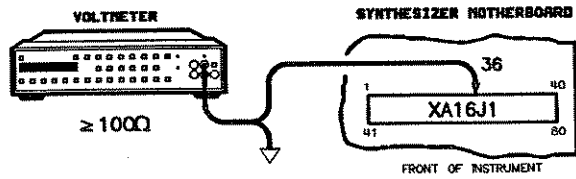

A16.322 Remove A16. Then measure the resistance of XA16J1-36 to ground.

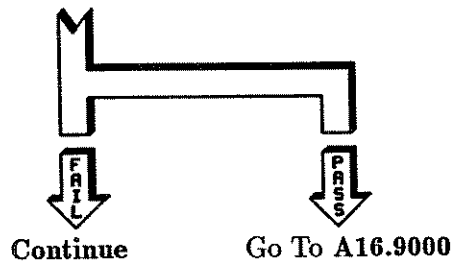
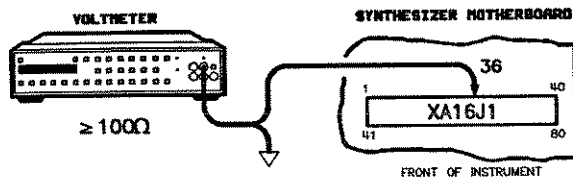

- A16.323** Remove the front panel completely. Refer to the disassembly procedures. Measure the resistance of XA16J1-36 to ground.

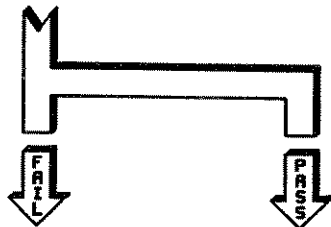
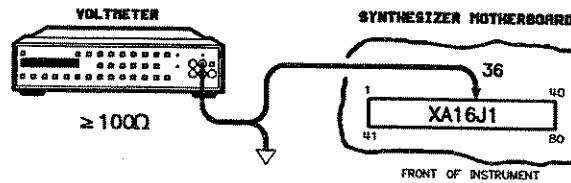

Go To A16.329 Continue

- A16.324** Connect W2 from the source module interface assembly (A2) to the motherboard (A22). Then measure the resistance of XA16J1-36 to ground.

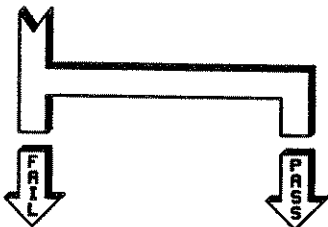
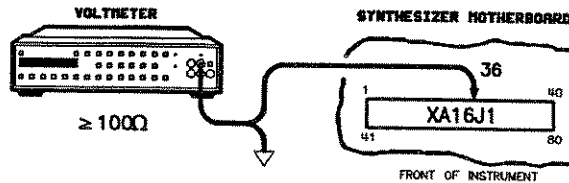

Go To A2.9000 Continue

A16.325 Do the following:

1. Connect W3 from the front panel processor (A3) to the motherboard (A22).
2. Disconnect the two ribbon cables (W1, W4) that connect the A3 front panel processor to the A21 display.
3. Measure the resistance of XA16J1-36 to ground.

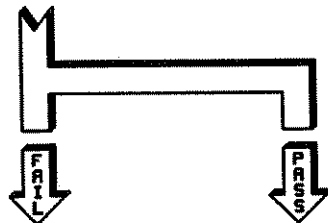
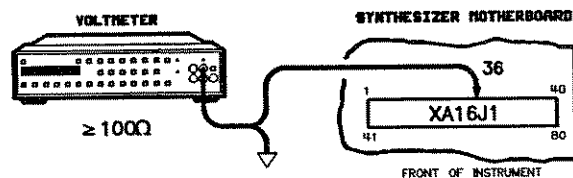

Go To A3.9000 Go To A21.9000

A16.329 Since all of the connections to the +13.6V power supply have been removed and the resistance measurement is still less than 100Ω, there is a short on the motherboard. Go to A22.9000 (replace the motherboard).

A16.360 Do the following:

1. Set the line power switch to STANDBY.
2. Disconnect the instrument from line power and wait until all A18 indicators are off.
3. Remove A18.
4. With the line switch in the STANDBY position, measure the resistance of XA18J1-25 to ground. Pin 25 is accessible from the component side (top) of the

motherboard. It is the pin at the left rear corner of connector XA18J1 as viewed with the instrument front panel facing towards you.

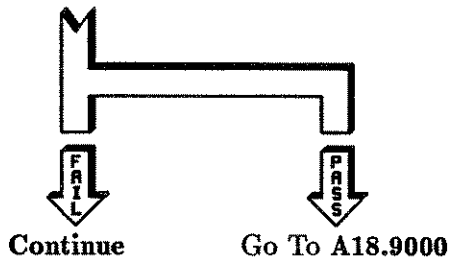
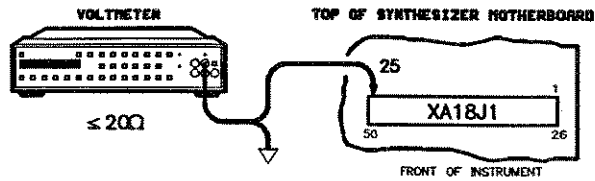

A16.361 Measure the resistance of A22J1-33 to ground with the power switch in STANDBY. Note that the numbering on the A22J1 connector may be incorrect. Pin 33 is the left-rear corner of A22J1.

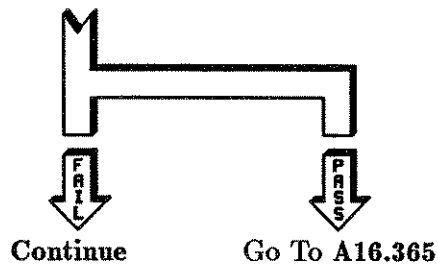
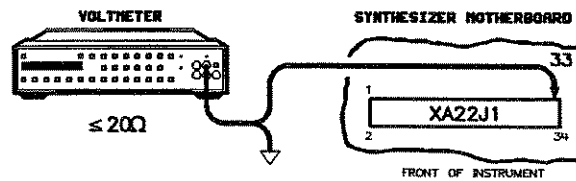

A16.362 Remove the front panel and check the seating of the ribbon cables connecting the front panel to the motherboard. If no seating problem is found, check the ribbon cable and replace it if damaged. Otherwise, go to A2.9000.

A16.365 An open exists between XA18J1-25 and A22J1-33. Do not attempt to repair this open. Go to A22.9000, and replace the motherboard.

A16.380 Select the first correct condition and go to the indicated paragraph.

Red (DS6) CURR LIMIT	Red (DS5) OVERVOLT	Red (DS4) OVERCURR	Red (DS3) OVERTEMP	Go To Paragraph
OFF	-	-	ON	A16.381
ON	-	-	ON	A16.383
ON	-	-	OFF	A16.384
OFF	ON	OFF	OFF	A16.384
OFF	ON	ON	OFF	A16.384
OFF	OFF	ON	OFF	A16.390

A dash (-) indicates a don't care condition.

A16.381 Has the instrument overheated (is the instrument very warm to the touch)?

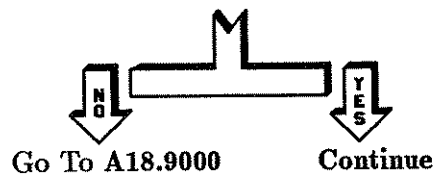

- A16.382** There are several things that could cause overheating. Two things to check are: the air flow and environment. For instance, is the fan blocked? Is the airflow on the sides of the instrument blocked? If the instrument is in a racked system, is the direction of airflow the same as other instruments in the system? If these conditions do not exist, take the following action:
1. Check all fuses on A16. There are six small plug-in fuses and two solder-in fuses. All the fuses are close to the bottom of the board.
 2. Check the fan connection to the motherboard (remove the rear panel and possibly the RF deck to gain access). See the disassembly instructions for more information.
 3. If these don't fix the problem then consider one or more of the following:
 - a. Replace the fan (see "Disassembly and Replacement Procedures" in the *Service* manual for instructions).
 - b. Replace A16 (go to A16.9000).
 - c. Replace A17 (go to A17.9000).

A16.383 Refer to A16.382. In addition, consider A18 for replacement (go to A18.9000). Finally, return to the Troubleshooting Foldout, block 1 (located just prior to the "Special Cases" tab).

- A16.384** Perform the following:
1. Set the line power switch to STANDBY.
 2. Disconnect power and wait for all indicators in the power supply to go out.
 3. Remove A17 and A18.
- Go to A16.205.

A16.385 In this case, change both A18 and A17. Go to A17.9000 then A18.9000. Then restart troubleshooting at A16.000. When you are confident that the power supply is good, begin troubleshooting at ILT.000.

A16.390 Do the following:

1. Set the line power switch to STANDBY.
2. Disconnect the instrument from ac line power.
3. Remove A15.
4. Connect the instrument to ac line power using an isolation transformer and set the line power switch to ON.

Is the A18 +5VHD OVER CURRENT indicator on?



Go To A15.9000

Continue

A16.391 Do the following:

1. Set the line power switch to STANDBY.
2. Disconnect the instrument from ac line power.
3. Wait for all the indicators in the power supply section to go out.
4. Install A15.
5. Install A16.
6. Remove the front panel and disconnect the ribbon cables W2 and W3 that connect the front panel to the motherboard.
7. Connect the instrument to ac line power using an isolation transformer and set the line power switch to ON.

Is the A18 +5VHD OVER CURRENT indicator on?

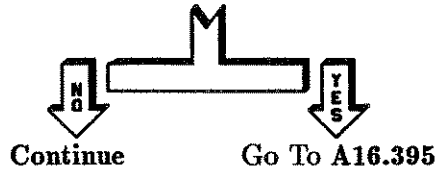

A16.392 Do the following:

1. Set the line power switch to STANDBY.
2. Disconnect the instrument from ac line power.
3. Wait for all the indicators in the power supply section to go out.
4. Reconnect W2.
5. Connect the instrument to ac line power through an isolation transformer and set the line power switch to ON.

Is the A18 +5VHD OVER CURRENT indicator on?



A16.395 Do the following:

1. Set the line power switch to STANDBY.
2. Disconnect the instrument from ac line power.
3. Wait for all the indicators in the power supply section to go out.
4. Install A15.
5. Remove A14.
6. Connect the instrument to ac line power using an isolation transformer and set the line power switch to ON.

Is the A18 +5VHD OVER CURRENT indicator on?

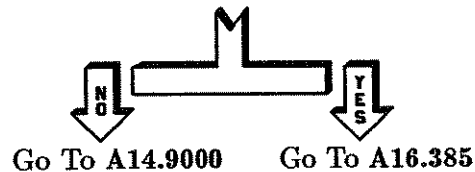

A16.400 Do the following:

1. Replace the line fuse.
2. Remove the rear panel.
3. Disconnect A22J10 wiring harness from the motherboard. This wiring harness connects the 22V toroidal transformer to the motherboard.
4. Ensure that the 22V wiring harness is out of the way and then replace the rear panel.
5. Connect the instrument to ac line power using an isolation transformer. Do *not* turn on the instrument.

Are any A18 indicators on?

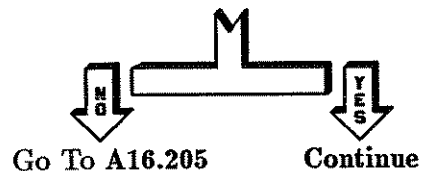

A16.401 Replace the 22 volt transformer and then go to the Troubleshooting Foldout, block 1 (located just prior to the "Special Cases" tab).

A16.500 Select the first correct condition and go to the indicated paragraph.

Neon HIGH VLT	Green +13.6V	Amber PREREGSHTDWN	Go To Paragraph
OFF	-	-	A16.205
ON	OFF	-	A16.560
ON	ON	-	A16.380

A dash (-) indicates a don't care condition.

A16.560 Do the following:

1. Set the line power switch to STANDBY.
2. Disconnect the instrument from ac line power.
3. Wait for all the indicators in the power supply section to go out.
4. Install A16.
5. Remove the front panel and disconnect the ribbon cables W2 and W3 that connect the front panel to the motherboard.
6. Connect the instrument to ac line power using an isolation transformer and set the line power switch to ON.

Is the +13.6V LED (green, DS1) on?

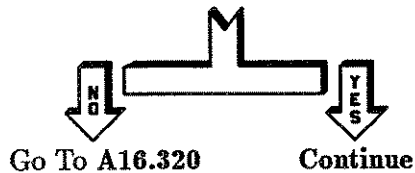

A16.561 Do the following:

1. Set the line power switch to STANDBY.
2. Disconnect the instrument from ac line power.
3. Wait for all the indicators in the power supply section to go out.
4. Reconnect W2.
5. Connect the instrument to ac line power using an isolation transformer and set the line power switch to ON.

Is the +13.6V LED (green, DS1) on?

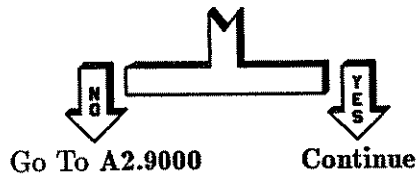

A16.562 Perform the following setup:

1. Set the line power switch to STANDBY.
2. Disconnect the instrument from ac line power.
3. Wait for all the indicators in the power supply section to go out.
4. Reconnect W3.
5. Disconnect the two ribbon cables (W1, W4) that connect the A3 front panel processor to the A21 display.
6. Connect the instrument to ac line power using an isolation transformer and set the line power switch to ON.

Is the +13.6V LED (green, DS1) on?

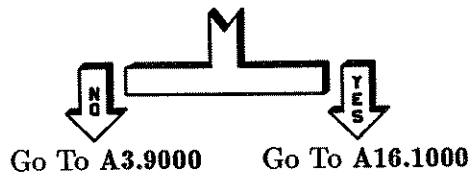

A16.600 Were the A18 indicators correct in the previous step?

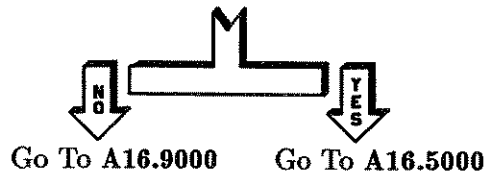

A16.700 Were *all* A18 indicators correct?

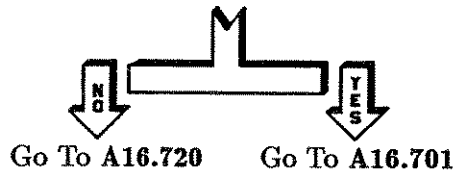

A16.701 Did the fan turn properly when power was turned on?

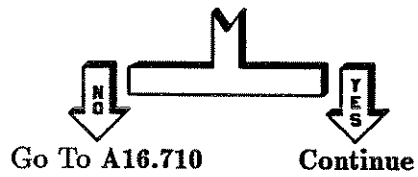

A16.702 Are any red A16 LEDs on?

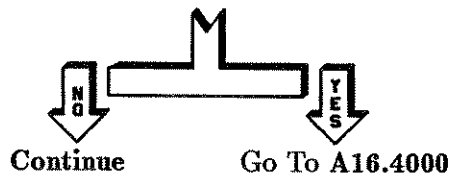

A16.703 Measure the voltage of the +13.6 Vdc supply at XA16J1-36 to ground.

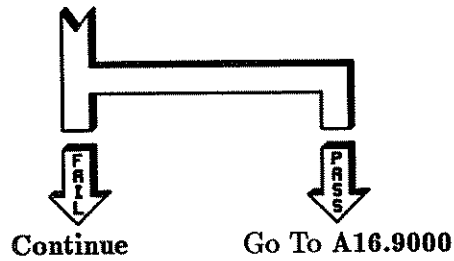
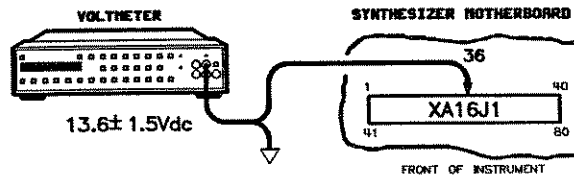

A16.704 Either an open exists on the motherboard between XA16J1-36 and XA18P1-49 or A18 is faulty. Verify the open with an ohmmeter. If an open does exist, do not attempt to repair it but go to A22.9000. If no open exists, go to A18.9000.

A16.710 Do the following:

1. Set the line power switch to STANDBY.
2. Disconnect the instrument from ac line power.
3. Wait for all the indicators in the power supply section to go out.
4. Remove A16.
5. Remove the rear panel and disconnect the fan.
6. Check all fuses on A16. There are six small plug-in fuses and two solder-in fuses. All the fuses are close to the bottom of the board.
7. Replace any fuses that are open.
8. Reinstall A16.
9. Connect the instrument to ac line power using an isolation transformer and set line power to ON (the fan should still be disconnected).

Continue with A16.711.

A16.711 Measure the voltage at XA16J1-1.

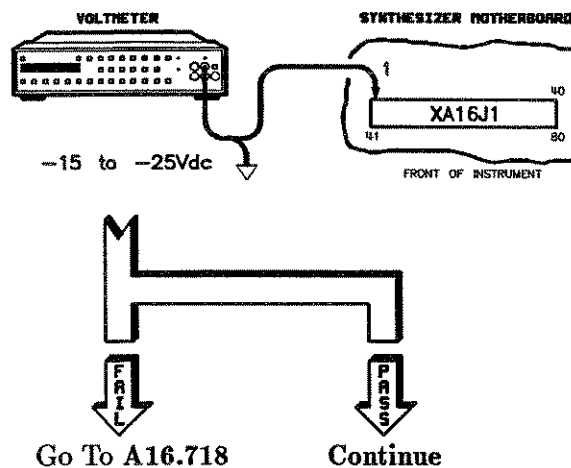

A16.712 Wait 2 to 3 minutes. Measure the voltage at XA16J1-41 for a positive voltage greater than 2.0 Vdc. This voltage may increase in value while the measurement is taken.

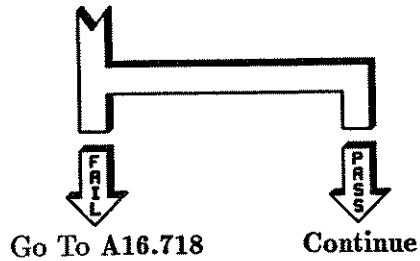
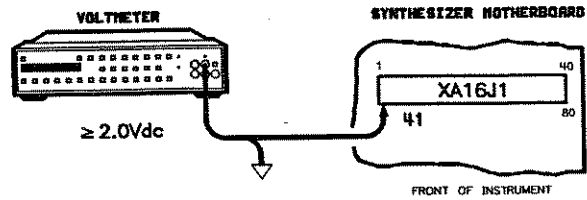

A16.713 Measure the voltage at A22J11-3. This connector is located at the right-rear of the instrument (by the fan).

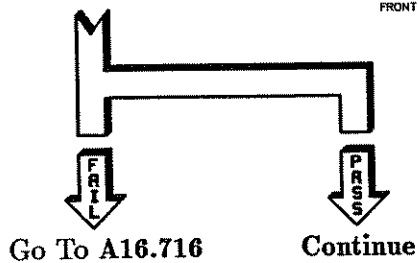
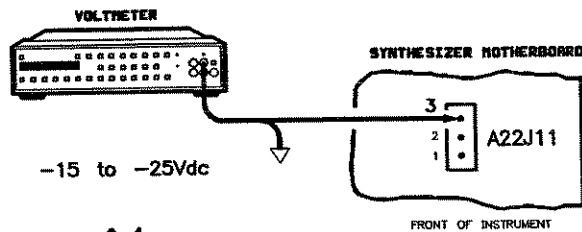

- A16.714** Wait 2 to 3 minutes. Measure the voltage at A22J11-1 for a positive voltage greater than 2.0 Vdc. This voltage may increase in value while the measurement is taken. This connector is located at the right-rear of the instrument (by the fan).

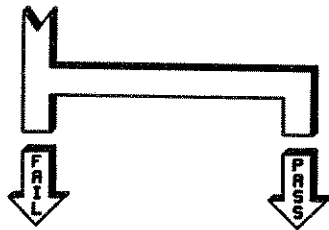
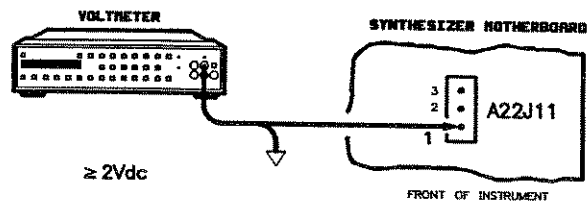

Go To A16.716 Continue

- A16.715** The fan is either defective or the instrument has an intermittent connection. Replace the fan and then go to the Troubleshooting Foldout, block 1 (located just prior to the "Special Cases" tab).

- A16.716** Reconnect the fan.

There is an open in the motherboard between one of the following two points.

- XA16J1-1 and A22J11-3.
- XA16J1-41 and A22J11-1.

Is a jumper wire on the motherboard an acceptable repair?

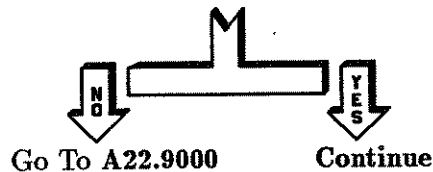

A16.717 Repair the motherboard and go to the Troubleshooting Foldout, block 1 (located just prior to the "Special Cases" tab).

A16.718 Do the following:

1. Set the line power switch to STANDBY.
2. Disconnect the instrument from ac line power.
3. Wait for all the indicators in the power supply section to go out.
4. Reconnect the fan.

Go to A16.9000.

A16.720 Do the following:

1. Set the line power switch to STANDBY.
2. Disconnect the instrument from ac line power.
3. Wait for all the indicators in the power supply section to go out.
4. Reconnect the fan.
5. Remove A18.
6. Check fuse A18F1.

Is the fuse damaged?

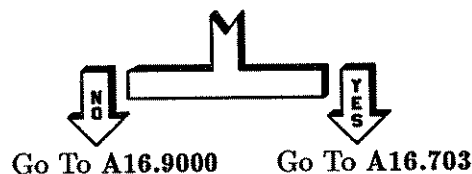

A16.1000

With the line power switch set to ON and the top cover removed, check the A16 power supply LEDs in the order shown. Choose the first LED that is *off* and go to the indicated paragraph. If all LEDs are on, go to A16.1001.

LED Name	Go To Paragraph
-40V	A16.4200
+5VHD	A16.9000
+22V STBY	A16.4300
-15V	A16.4400
-5V	A16.4500
+5V	A16.4600
+8V	A16.4700
+15V	A16.4800

A16.1001 Is the red A16 PRS LED (post regulator shutdown) on?

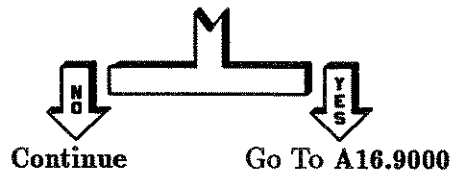

A16.1002 Is the red A16 PRA LED (post regulator alert) on?

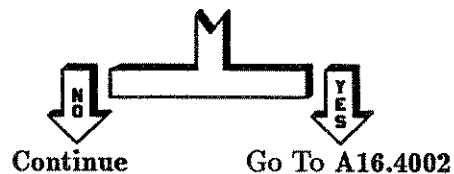

A16.2000

Measure the power supply voltages in the order given. Measure all of the voltages at the test points on the top edge of A16. If a voltage is out of specification, go to the paragraph indicated.

Note

These power supply voltages and tolerances rely on a DC voltmeter accuracy of better than $\pm 0.5\%$. If your voltmeter is less accurate, compensate accordingly.

Power Supply Name	Nominal Voltage	Tolerance	Go To Paragraph
-40V	-40 Vdc	± 0.8 Vdc	A16.9000
+22V STBY	+22 Vdc	± 0.4 Vdc	A16.9000
-15V	-15.07 Vdc	± 0.3 Vdc	A16.9000
-5V	-5.2 Vdc	± 0.1 Vdc	A16.9000
+5V	+5.2 Vdc	± 0.1 Vdc	A16.9000
+8V	+8 Vdc	± 0.2 Vdc	A16.9000
+15V	+15.12 Vdc	± 0.3 Vdc	A16.9000
+5VHD	TTL Hi	TTL Hi	A17.9000
H+5VAUp	TTL Hi	TTL Hi	A16.9000

If no errors occur, go to "Special Cases" or restart troubleshooting with ILT.000.

A16.4000

Is the red A16 PRS LED (post regulator shutdown) off?

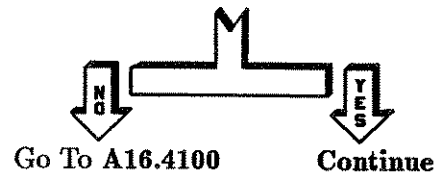

A16.4001 Are all green LEDs on the A16 assembly on?

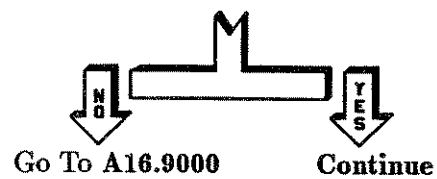

A16.4002 Do the following:

1. Set line power switch to STANDBY.
2. Disconnect the instrument from line power.
3. Wait for all the indicators in the power supply section to go out.
4. Remove A15.
5. Reconnect the instrument to line power using an isolation transformer.
6. Set the line power switch to ON.

Is the red A16 PRA LED (post regulator alert) on?

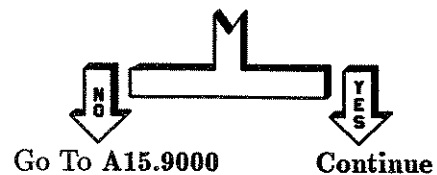

A16.4003 Do the following:

1. Set line power switch to STANDBY.
2. Disconnect the instrument from line power.
3. Wait for all the indicators in the power supply section to go out.
4. Install A15.
5. Remove the front panel and disconnect ribbon cable W3 from the motherboard.
6. Reconnect the instrument to line power using an isolation transformer.
7. Set the line power switch to ON.

Is the red A16 PRA LED still on?



Go To A3.9000

Continue

A16.4004 Do the following:

1. Set line power switch to STANDBY.
2. Disconnect the instrument from line power.
3. Wait for all the indicators in the power supply section to go out.
4. Remove A16.

Measure the resistance from XA16J1-78 to ground.

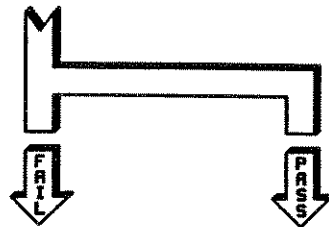
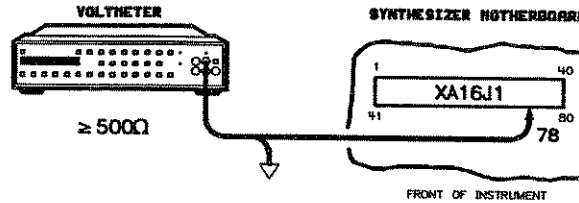

Go To A22.9000

Go To A16.4900

A16.4100 With the line power switch set to ON and the top cover removed, check the A16 power supply LEDs in the order given. Choose the first LED that is *off* and go to the indicated paragraph. If all LEDs are on, go to A16.9000.

LED Name	Go To Paragraph
-40V	A16.4200
+5VHD	A16.9000
+22V STBY	A16.4300
-15V	A16.4400
-5V	A16.4500
+5V	A16.4600
+8V	A16.4700
+15V	A16.4800

A16.4200 Measure the -40 Vdc unregulated supply at XA16J1-23 and 63.

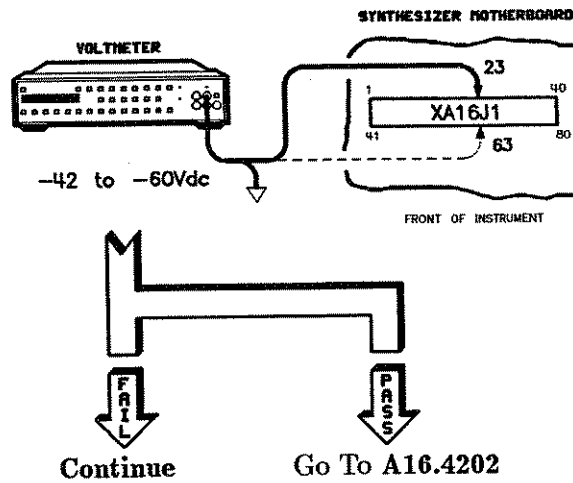

A16.4201 Do the following:

1. Set line power switch to STANDBY.
2. Disconnect the instrument from line power.
3. Wait for all the indicators in the power supply section to go out.
4. Remove A16.

Measure the -40 Vdc unregulated supply from A17 to A16 at XA16J1-23 and 63.

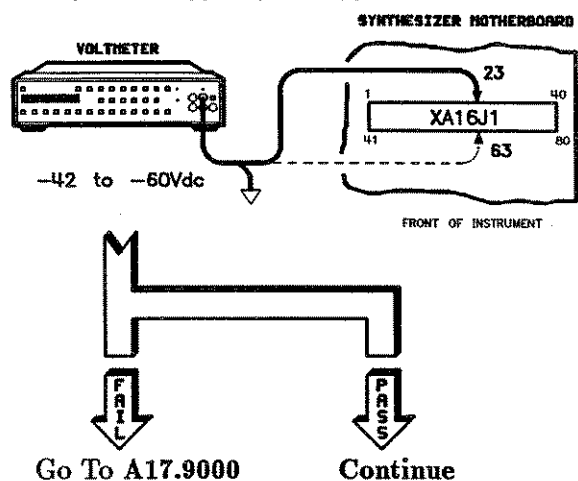

A16.4202 Do the following if not already performed:

1. Set line power switch to STANDBY.
2. Disconnect the instrument from line power.
3. Wait for all the indicators in the power supply section to go out.
4. Remove A16.

Measure the resistance of the -40 Vdc supply to ground (XA16J1-62 to ground).

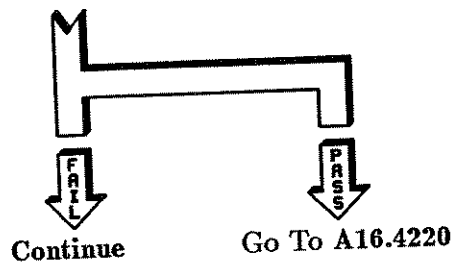
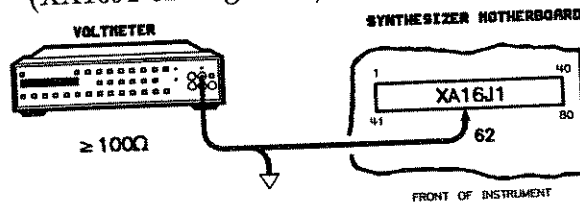

A16.4203 Remove the following assemblies:

- A11 FM driver.
- A12 SYTM driver.
- A13 YO driver.
- A14 sweep generator.

Measure the resistance of the -40 Vdc supply to ground (XA16J1-62 to ground).

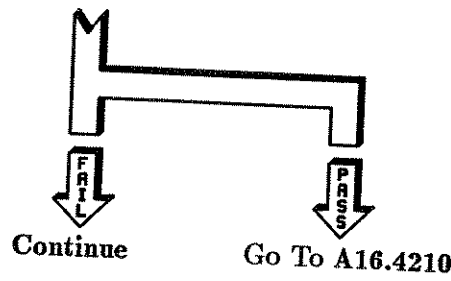
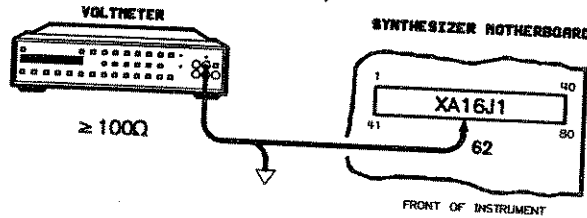

A16.4204 Refer to the disassembly procedures to remove the RF deck. Measure the resistance of the -40 Vdc supply to ground (XA16J1-62 to ground).

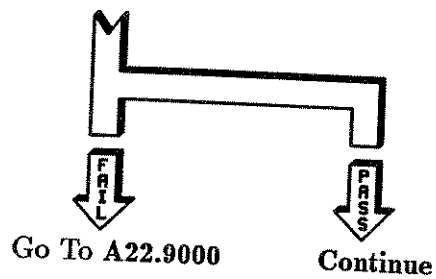
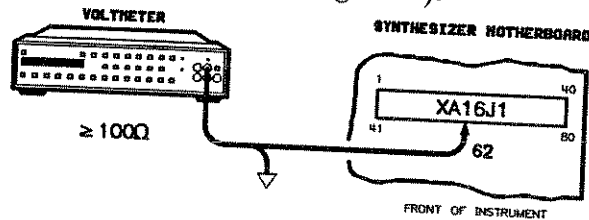

A16.4205

Reinstall the RF deck in the *service position*. Refer to the disassembly procedures. Remove the ribbon cables that connect the microcircuits to the RF deck:

Measure the resistance of the -40 Vdc supply to ground (XA16J1-62 to ground).

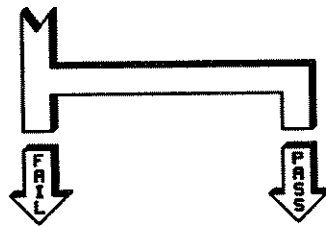
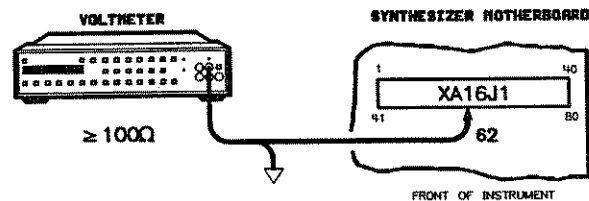

Go To A20.9000

Continue

A16.4206

Reconnect the microcircuit ribbon cables one at a time while measuring the resistance of the -40 Vdc to ground (XA16J1-62 to ground). Replace the microcircuit that causes a resistance measurement of $< 100\Omega$. Also, check the -40 V fuse on A16 and replace it if open. If no microcircuit causes a low resistance measurement, you may have removed the defect in the disassembly process or the problem may be intermittent. Go to the Troubleshooting Foldout, block 1 (located just prior to the "Special Cases" tab).

A16.4210 Reinstall the previously removed assemblies one at a time while measuring the resistance of the -40Vdc supply to ground (XA16J1-62 to ground). Replace the assembly that causes a resistance measurement of $< 100\Omega$. Also check the -40V fuse on A16 and replace it if defective. If no assembly causes a low resistance measurement, you may have removed the defect in the disassembly process or the problem may be intermittent. Go to the Troubleshooting Foldout, block 1 (located just prior to the "Special Cases" tab).

A16.4220 Check the -40V fuse on A16.
Is the fuse defective?

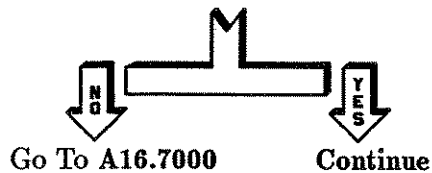

A16.4221 Do the following:

1. Replace the defective fuse.
2. Install A16.
3. Connect the instrument to line power using an isolation transformer.
4. Set the line power switch to ON.

Is the green A16 -40V LED on?

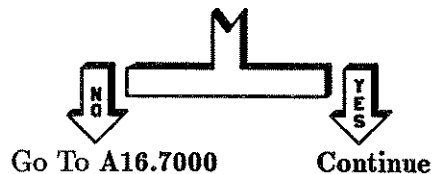

Replacing the fuse seems to have fixed the problem, but this simple solution is suspect. You may want to monitor the instrument for several minutes with the covers on to insure that an intermittent problem does not exist. Go

to the Troubleshooting Foldout, block 1 (located just prior to the "Special Cases" tab).

A16.4300 Do the following if not already performed:

1. Set line power switch to STANDBY.
2. Disconnect the instrument from line power.
3. Wait for all the indicators in the power supply section to go out.
4. Remove A16.

Measure the resistance of the +22Vdc supply to ground (XA16J1-2, 42 to ground).

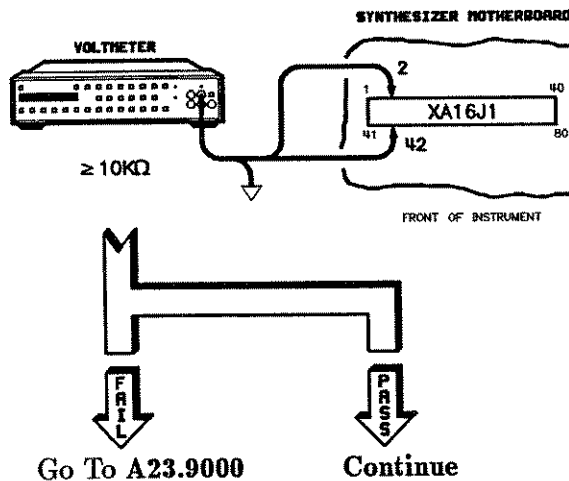

A16.4301 Do the following if not already performed:

1. Set line power switch to STANDBY.
2. Disconnect the instrument from line power.
3. Wait for all the indicators in the power supply section to go out.

Measure the resistance of the +22Vdc supply to ground (XA16J1-43 to ground).

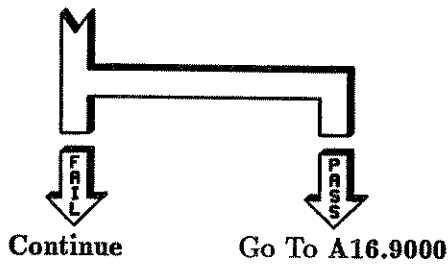
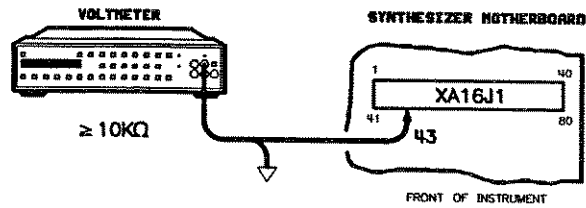

A16.4302 Remove A12. Measure the resistance of +22Vdc to ground (XA16J1-43 to ground).

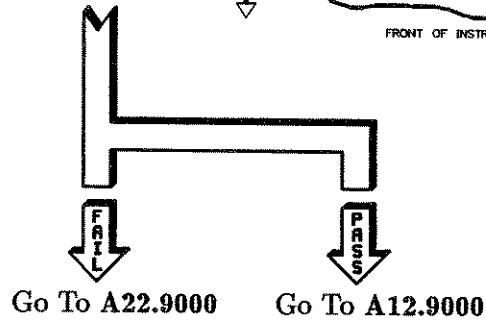
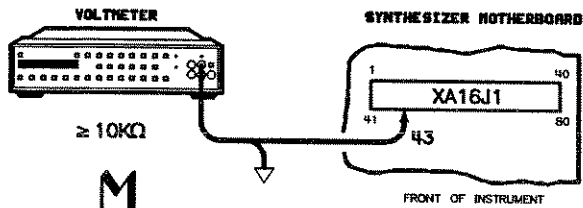

A16.4400 Measure the voltage of the -15 Vdc unregulated supply from A17 to A16 at XA16J1-27, 28, 67, and 68.

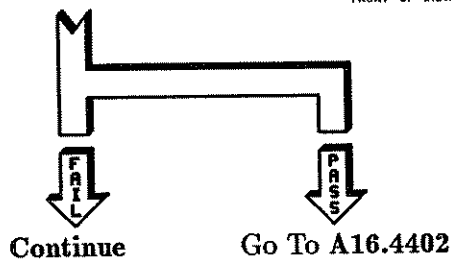
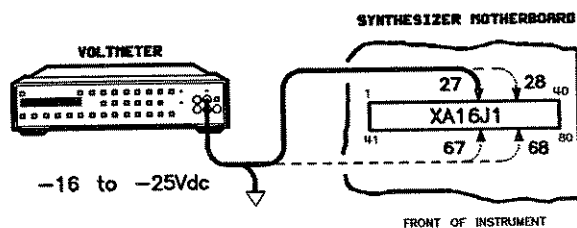

When the instrument is connected to ac line power or the A18 high voltage neon indicator is on, there are voltages present that can cause personal injury or death. Only trained, qualified personnel, who are aware of the hazards involved, should perform service on this instrument with its protective covers removed. An isolation transformer must be used during all these procedures.

Observe all safety practices. Remove all jewelry/metal that can short to ground.

A16.4401 Do the following:

1. Set line power switch to STANDBY.
2. Disconnect the instrument from line power.
3. Wait for all the indicators in the power supply section to go out.
4. Remove A16.
5. Connect the instrument to line power using an isolation transformer.
6. Set the line power switch to ON.

Measure the -15 Vdc unregulated supply from A17 to A16 at XA16J1-27, 28, 67, and 68.

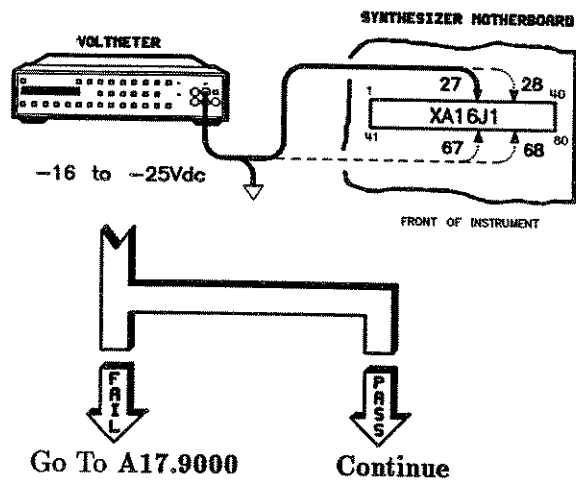

A16.4402 Do the following if not already performed:

1. Set line power switch to STANDBY.
2. Disconnect the instrument from line power.
3. Wait for all the indicators in the power supply section to go out.
4. Remove A16.

Measure the resistance of the -15 Vdc supply to ground (XA16J1-25, 26, 65, and 66 to ground).

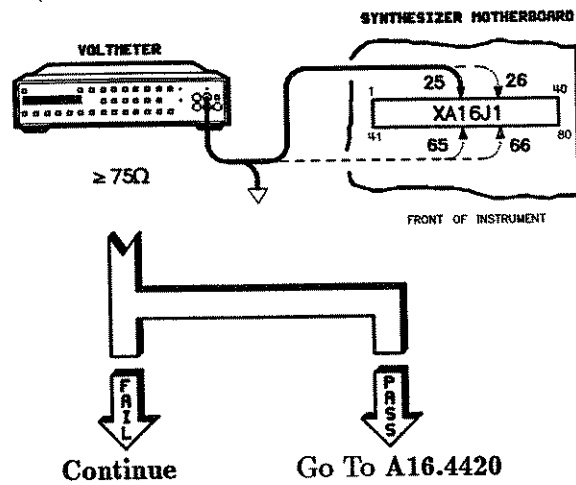

A16.4403 Remove the following assemblies:

- A4 fractional-N.
- A5 YO phase detector.
- A7 reference.
- A9 pulse.
- A11 FM driver.
- A12 SYTM driver.
- A13 YO driver.
- A14 sweep generator.
- A15 microprocessor.
- A6 sampler.

Note



Be sure to disconnect the rigid cable connected to the input of A6 before removing A6. Otherwise damage to the cable, A6, and possibly the filter (FL2) can occur.

Measure the resistance of the -15 Vdc supply to ground (XA16J1-25, 26, 65, and 66 to ground).

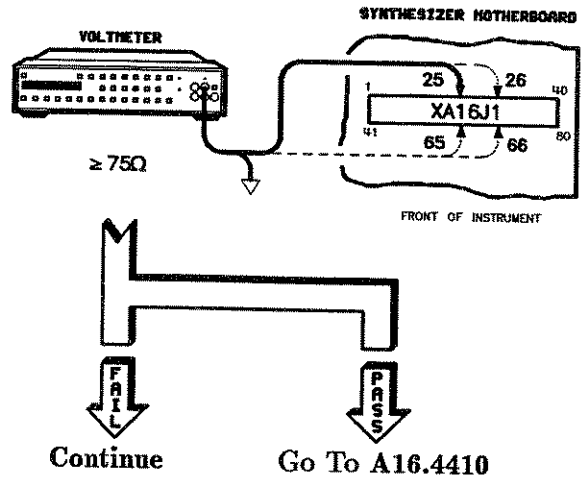

A16.4404 Follow the disassembly procedures to remove the RF deck.

Measure the resistance of the -15 Vdc supply to ground (XA16J1-25, 26, 65, and 66 to ground).

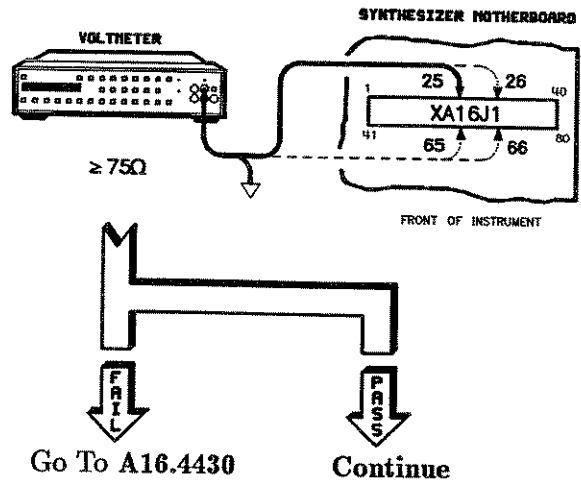

- A16.4405** Reinstall the RF deck in the *service position*. Refer to the disassembly procedures as needed. Remove the ribbon cables that connect the microcircuits to the RF deck: Measure the resistance of the -15 Vdc supply to ground (XA16J1-25, 26, 65, and 66 to ground).

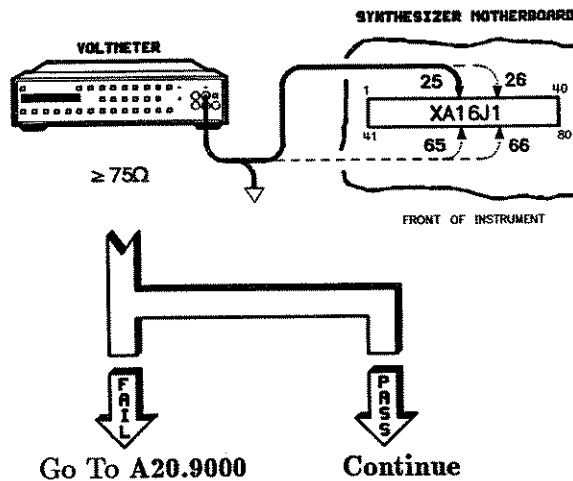

- A16.4406** Reconnect the microcircuit ribbon cables one at a time while measuring the resistance of the -15 Vdc supply to ground (XA16J1-25, 26, 65, and 66 to ground). Replace the microcircuit that causes a $< 75\Omega$ resistance measurement. Also, check the -15 V fuse on A16 and replace it if open.

Did a microcircuit cause a low resistance measurement?

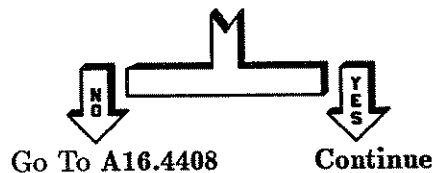

A16.4407

Go to the paragraph indicated below to replace the faulty microcircuit.

Microcircuit	Go To Paragraph
A29 amp/filter	RF.2990
A28 amp/multiplier	RF.2890
A26 YO	RF.2690
A24 low band	RF.2490
A31 attenuator	RF.3190
A32 amp/doubler	RF.3290
A33 amp switch	RF.3390

A16.4408

You may have removed the defect in the disassembly process or the problem may be intermittent. Also check the -15V fuse on A16 and replace it if open. Go to the Troubleshooting Foldout, block 1 (located just prior to the "Special Cases" tab).

A16.4410

Reinstall the previously removed assemblies one at a time while measuring the resistance of the -15Vdc to ground (XA16J1-25, 26, 65, and 66 to ground). Replace the assembly that causes a resistance measurement of $< 75\Omega$. If no assembly causes a low resistance measurement, you may have removed the defect in the disassembly process or the problem may be intermittent. Also check the -15V fuse on A16 and replace it if open. Go to the Troubleshooting Foldout, block 1 (located just prior to the "Special Cases" tab).

A16.4420 Check the -15V fuse on A16.

Is the fuse open?

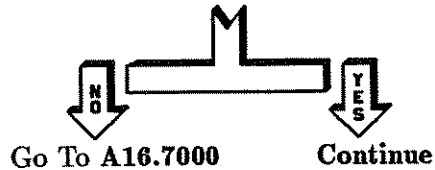

A16.4421 Do the following:

1. Replace the defective fuse.
2. Install A16.
3. Connect the instrument to line power using an isolation transformer.
4. Set the line power switch to ON.

Is the green -15V LED on?

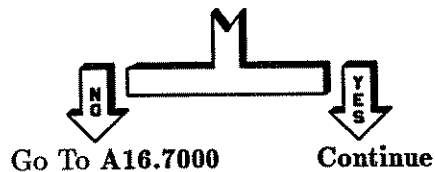

Replacing the fuse seems to have fixed the problem, but this simple solution is suspect. You may want to monitor the instrument for several minutes with the covers on to insure that an intermittent problem does not exist. Go to the Troubleshooting Foldout, block 1 (located just prior to the "Special Cases" tab).

A16.4430 Follow the disassembly procedures (in the *Service manual*) to remove the rear panel and disconnect ribbon cable, W31 from the motherboard. Measure the resistance of the -15 Vdc supply to ground (XA16J1-25, 26, 65, and 66 to ground).

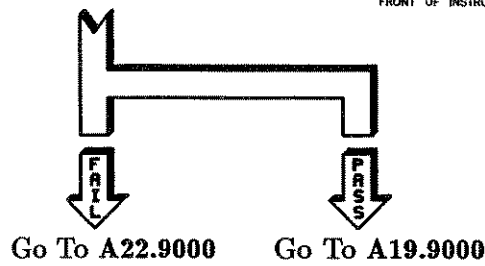
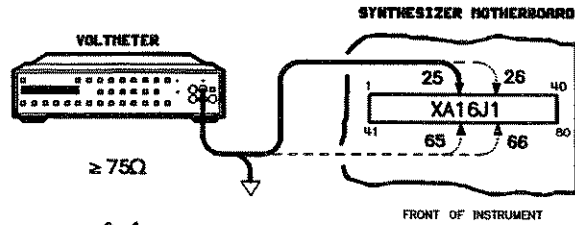

A16.4500 Measure the voltage of the -5 Vdc unregulated supply from A17 to A16 at XA16J1-20, 21, 60, and 61.

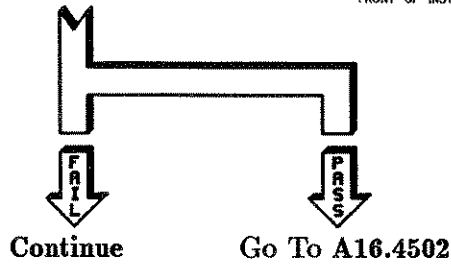
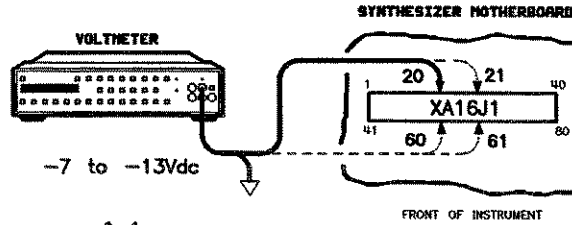

A16.4501 Do the following:

1. Set line power switch to STANDBY.
2. Disconnect the instrument from line power.
3. Wait for all the indicators in the power supply section to go out.
4. Remove A16.
5. Connect the instrument to line power using an isolation transformer.
6. Set the line power switch to ON.

Measure the voltage of the -5 Vdc unregulated supply from A17 to A16 at XA16J1-20, 21, 60, and 61.

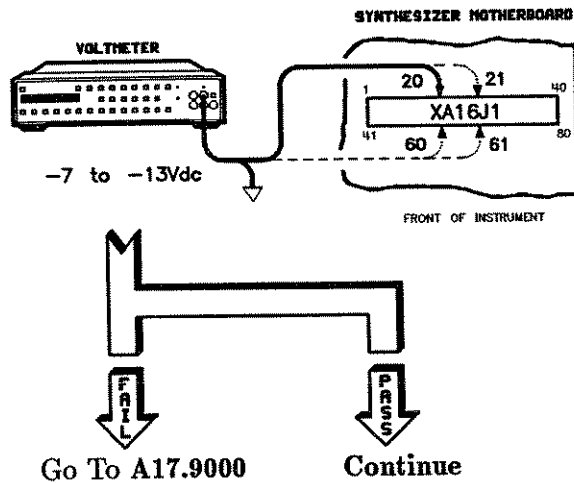

A16.4502 Do the following if not already performed:

1. Set line power switch to STANDBY.
2. Disconnect the instrument from line power.
3. Wait for all the indicators in the power supply section to go out.
4. Remove A16.

Measure the resistance of the -5 Vdc supply to ground (XA16J1-18, 19, 58, and 59 to ground).

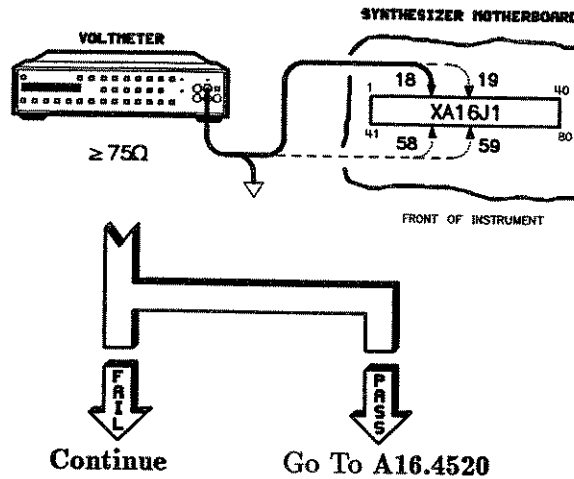

A16.4503 Remove the following assemblies:

- A4 fractional-N.
- A5 YO phase detector.
- A7 reference.
- A9 pulse.
- A11 FM driver.
- A12 SYTM driver.
- A13 YO driver.
- A14 sweep generator.
- A15 microprocessor.
- A6 sampler.

Note



Be sure to disconnect the rigid cable connected to the input of A6 before removing A6. Otherwise damage to the cable, A6, and possibly the filter (FL2) can occur.

Measure the resistance of the -5 Vdc supply to ground (XA16J1-18, 19, 58, and 59 to ground).

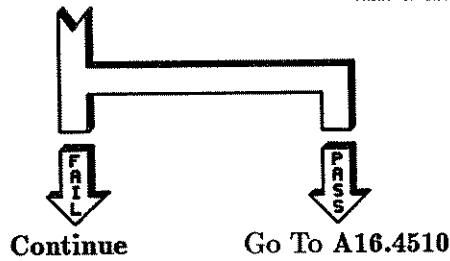
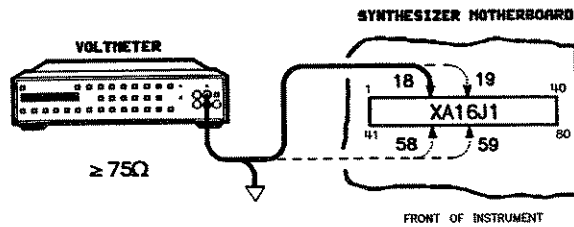

A16.4504 Refer to the disassembly procedures to remove the RF deck. Measure the resistance of the -5 Vdc supply to ground (XA16J1-18, 19, 58, and 59 to ground).

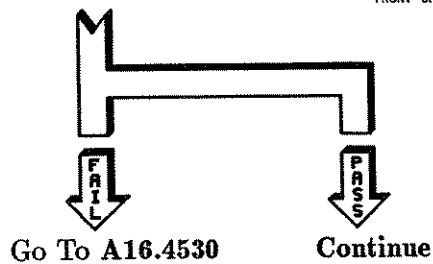
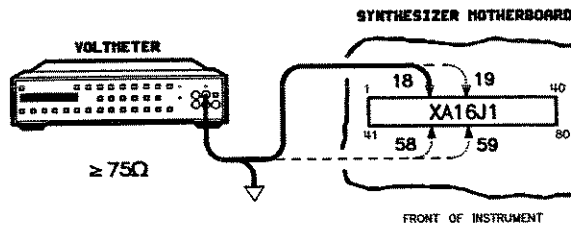

A16.4505 Refer to the disassembly procedures and reinstall the RF deck in the *service position*. Remove the ribbon cables that connect the microcircuits to the RF deck.

Measure the resistance of the -5 Vdc supply to ground (XA16J1-18, 19, 58, and 59 to ground).

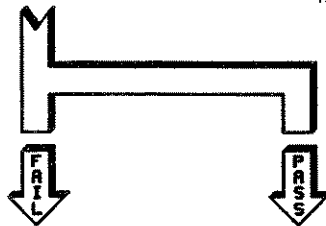
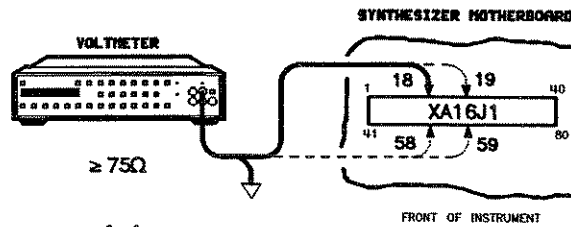

Go To A20.9000

Continue

A16.4506 Reconnect the microcircuit ribbon cables one at a time while measuring the resistance of the -5 Vdc supply to ground (XA16J1-18, 19, 58, and 59 to ground). Also check the -5V fuse on A16 and replace it if open.

Does a microcircuit cause a resistance measurement of $< 75\Omega$?



Go To A16.4508

Continue

A16.4507

Go to the paragraph indicated to replace the faulty microcircuit.

Microcircuit	Go To Paragraph
A29 amp/filter	RF.2990
A28 amp/multiplier	RF.2890
A26 YO	RF.2690
A24 low band	RF.2490
A31 attenuator	RF.3190
A32 amp/doubler	RF.3290
A33 amp switch	RF.3390

A16.4508

You may have removed the defect in the disassembly process or the problem may be intermittent. Also check the $-5V$ fuse on A16 and replace it if open. Go to Troubleshooting Foldout, block 1 (located just prior to the "Special Cases" tab).

A16.4510

Reinstall the previously removed assemblies one at a time while checking the resistance of the $-5 Vdc$ supply to ground (XA16J1-18, 19, 58, 59 to ground). Replace the assembly that causes a resistance measurement of $< 75\Omega$. If no assembly causes a low resistance measurement, you may have removed the defect in the disassembly process or the problem may be intermittent. Also check the $-5V$ fuse on A16 and replace it if open. Go to Troubleshooting Foldout, block 1 (located just prior to the "Special Cases" tab).

A16.4520 Check the $-5V$ fuse on A16.

Is the fuse open?

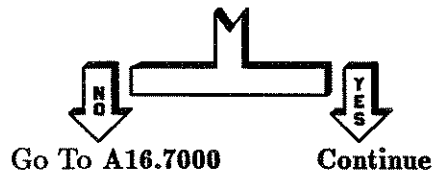

A16.4521 Do the following:

1. Replace the defective fuse.
2. Install A16.
3. Connect the instrument to line power using an isolation transformer.
4. Set the line power switch to ON.

Is the green $-5V$ LED on?

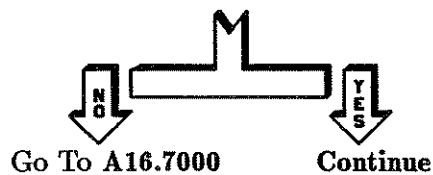

Replacing the fuse seems to have fixed the problem, but this simple solution is suspect. You may want to monitor the instrument for several minutes with the covers on to insure that an intermittent problem does not exist. Go to the Troubleshooting Foldout, block 1 (located just prior to the "Special Cases" tab).

A16.4530 Refer to the disassembly procedures to remove the rear panel and disconnect ribbon cable, W31, from the motherboard. Measure the resistance of the -5 Vdc supply to ground (XA16J1-18, 19, 58, and 58 to ground).

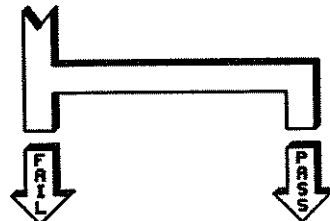
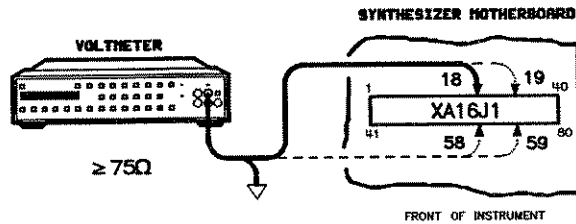

Go To A22.9000

Go To A19.9000

A16.4600 Measure the voltage of the +5 Vdc unregulated supply from A17 to at XA16J1-15, 16, 55, and 56.

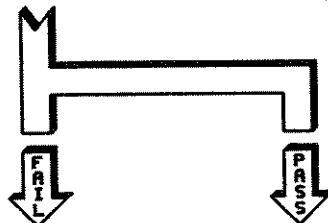
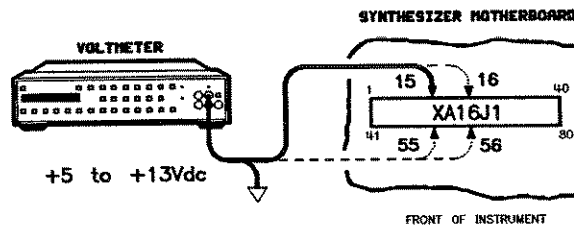

Continue

Go To A16.4602

A16.4601 Do the following:

1. Set line power switch to STANDBY.
2. Disconnect the instrument from line power.
3. Wait for all the indicators in the power supply section to go out.
4. Remove A16.
5. Connect the instrument to line power using an isolation transformer.
6. Set the line power switch to ON.

Measure the voltage of the +5 Vdc unregulated supply from A17 to A16 at XA16J1-15, 16, 55, and 56.

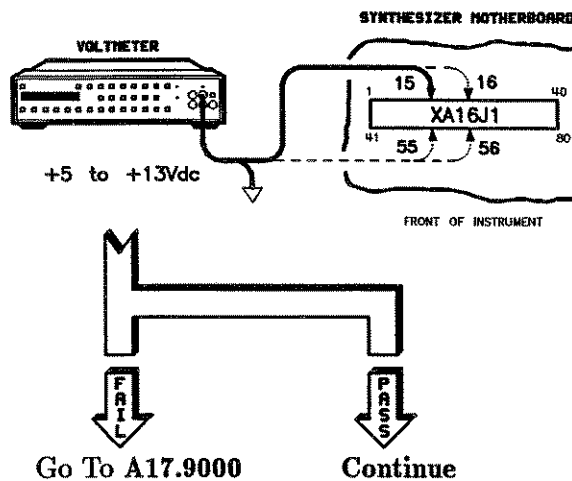

A16.4602 Do the following if not already performed:

1. Set line power switch to STANDBY.
2. Disconnect the instrument from line power.
3. Wait for all the indicators in the power supply section to go out.
4. Remove A16.

Measure the resistance of the +5 Vdc supply to ground (XA16J1-13, 14, 39, 40, 53, 54, 79, and 80 to ground).

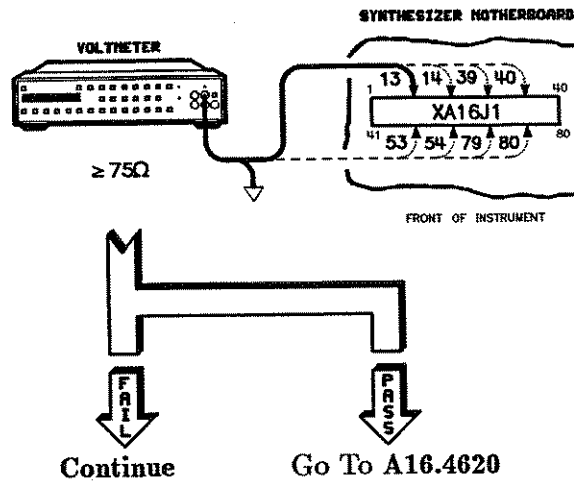

A16.4603 Remove the following assemblies:

- A4 fractional-N.
- A5 YO phase detector.
- A7 reference.
- A9 pulse.
- A11 FM driver.
- A12 SYTM driver.
- A13 YO driver.
- A14 sweep generator.
- A15 microprocessor.
- A6 sampler.

Note



Be sure to disconnect the rigid cable connected to the input of A6 before removing A6. Otherwise damage to the cable, A6, and possibly the filter (FL2) can occur.

Measure the resistance of the +5 Vdc supply to ground (XA16J1-13, 14, 39, 40, 53, 54, 79, and 80 to ground).

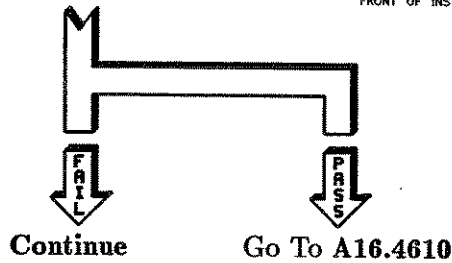
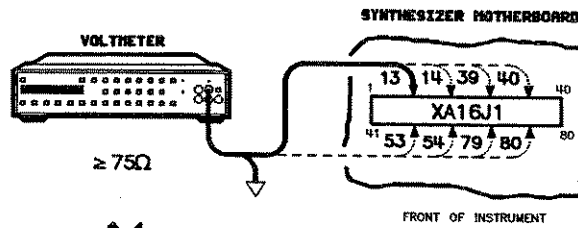

A16.4604 Refer to the disassembly procedures and remove the RF deck.

Measure the resistance of the +5 Vdc supply to ground (XA16J1-13, 14, 39, 40, 53, 54, 79, and 80 to ground).

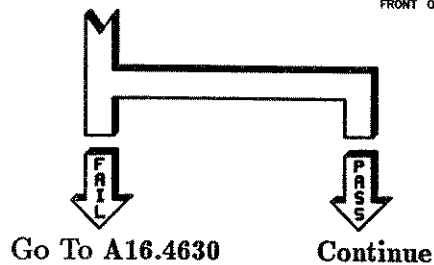
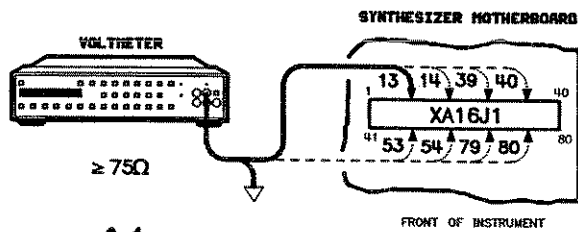

A16.4605 Reinstall the RF deck in the *service position*. Refer to the disassembly procedures. Remove the ribbon cables that connect the microcircuits to the RF deck:

Measure the resistance of the +5 Vdc supply to ground (XA16J1-13, 14, 39, 40, 53, 54, 79, and 80 to ground).

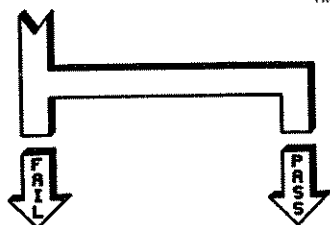
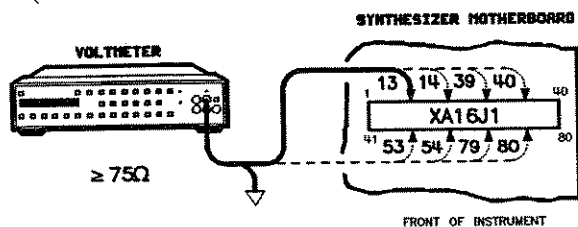

Go To A20.9000

Continue

A16.4606 Reconnect the microcircuit ribbon cables one at a time while measuring the resistance of the +5 Vdc supply to ground (XA16J1-13, 14, 39, 40, 53, 54, 79, and 80 to ground). Finally, check the +5V fuse on A16 and replace it if open.

Did a microcircuit cause a resistance measurement of $< 75\Omega$?



Go To A16.4608

Continue

A16.4607

Go to the paragraph indicated to replace the faulty microcircuit.

Microcircuit	Go To Paragraph
A29 amp/filter	RF.2990
A28 amp/multiplier	RF.2890
A26 YO	RF.2690
A24 low band	RF.2490
A31 attenuator	RF.3190
A32 amp/doubler	RF.3290
A33 amp switch	RF.3390

A16.4608

You may have removed the defect in the disassembly process or the problem may be intermittent. Also check the +5V fuse on A16. Replace it if defective. Go to Troubleshooting Foldout, block 1 (located just prior to the "Special Cases" tab).

A16.4610

Reinstall the previously removed assemblies one at a time while measuring the resistance of the +5 Vdc supply to ground (XA16J1-13, 14, 39, 40, 53, 54, 79, and 80 to ground). Replace the assembly that causes a resistance measurement of $< 75\Omega$. If no assembly causes a low resistance measurement, you may have removed the defect in the disassembly process or the problem may be intermittent. Also check the +5V fuse on A16. Replace it if defective. Go to Troubleshooting Foldout, block 1 (located just prior to the "Special Cases" tab).

A16.4620 Check the +5V fuse on A16.

Is the fuse defective?

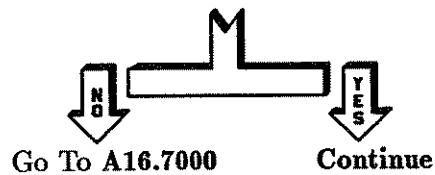

A16.4621 Do the following:

1. Replace the defective fuse.
2. Install A16.
3. Connect the instrument to line power using an isolation transformer.
4. Set the line power switch to ON.

Is the green +5V LED on?

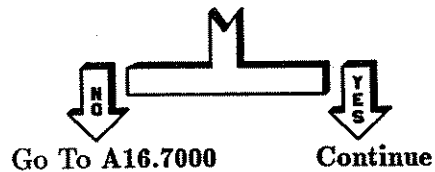

Replacing the fuse seems to have fixed the problem, but this simple solution is suspect. You may want to monitor the instrument for several minutes with the covers on to insure that an intermittent problem does not exist. Go to the Troubleshooting Foldout, block 1 (located just prior to the "Special Cases" tab).

A16.4630 Refer to the disassembly procedures to remove the rear panel and disconnect ribbon cable, W31 from the motherboard. Measure the resistance of the +5 Vdc supply to ground (XA16J1-13, 14, 39, 40, 53, 54, 79, and 80 to ground).

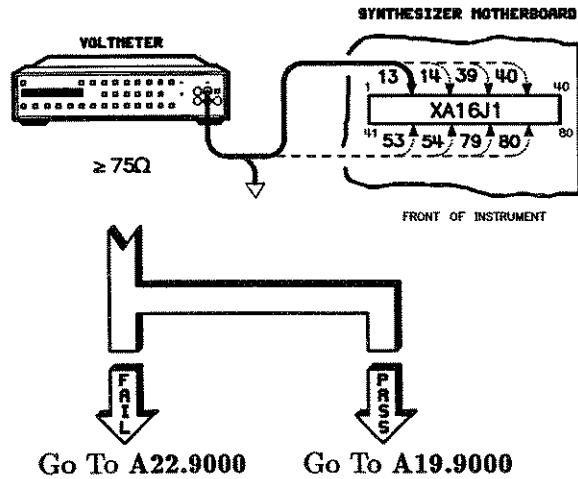

A16.4700 Measure the voltage of the +8 Vdc unregulated supply from A17 to A16 at XA16J1-9, 10, 49, and 50.

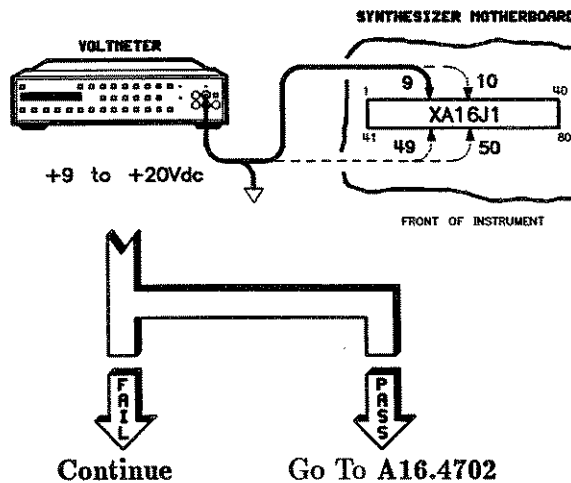

A16.4701 Do the following:

1. Set line power switch to STANDBY.
2. Disconnect the instrument from line power.
3. Wait for all the indicators in the power supply section to go out.
4. Remove A16.
5. Connect the instrument to line power using an isolation transformer.
6. Set the line power switch to ON.

Measure the voltage of the +8 Vdc unregulated supply from A17 to A16 at XA16J1-9, 10, 49, and 50.

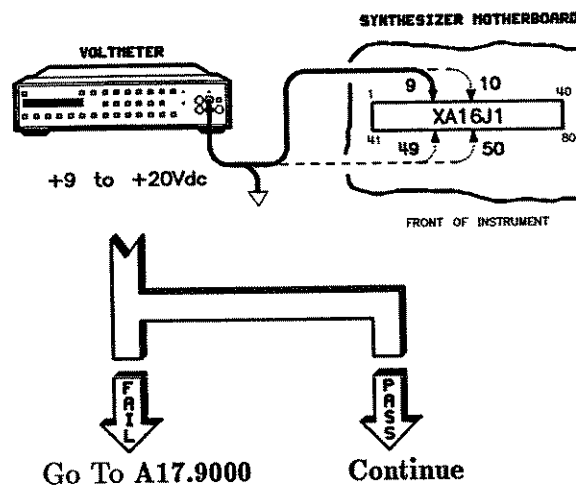

A16.4702 Do the following if not already performed:

1. Set line power switch to STANDBY.
2. Disconnect the instrument from line power.
3. Wait for all the indicators in the power supply section to go out.
4. Remove A16.

Measure the resistance of the +8 Vdc supply to ground (XA16J1-7, 8, 47, and 48 to ground).

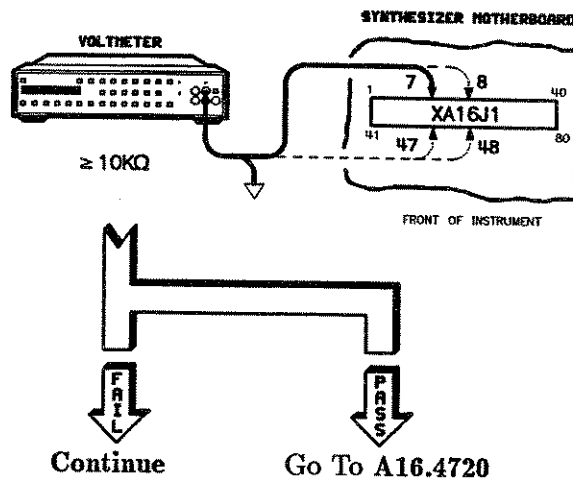

A16.4703 Remove the following assemblies:

- A4 fractional-N.
- A5 YO phase detector.
- A7 reference.
- A9 pulse.
- A11 FM driver.
- A12 SYTM driver.
- A13 YO driver.
- A14 sweep generator.
- A15 microprocessor.
- A6 sampler.

Note



Be sure to disconnect the rigid cable line connected to the input of A6 before removing A6. Otherwise damage to the cable, A6, and possibly the filter (FL2) can occur.

Measure the resistance of the +8 Vdc supply to ground (XA16J1-7, 8, 47, and 48 to ground).

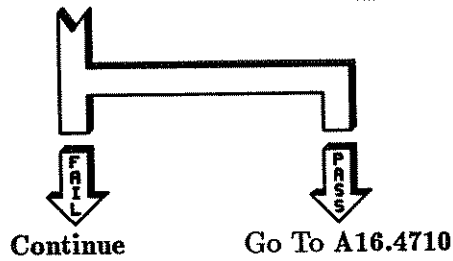
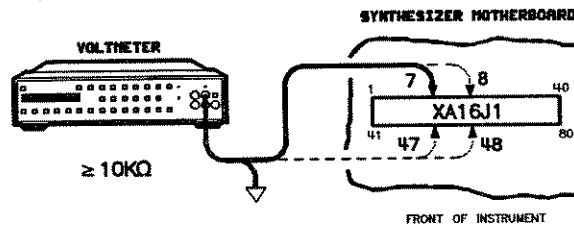

A16.4704 Refer to the disassembly procedures to remove the RF deck.

Measure the resistance of the +8 Vdc supply to ground (XA16J1-7, 8, 47, and 48 to ground).

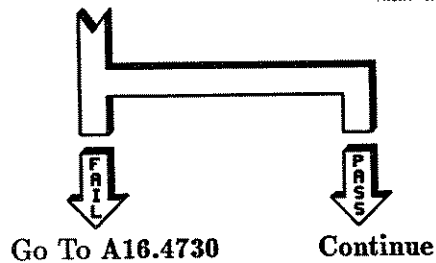
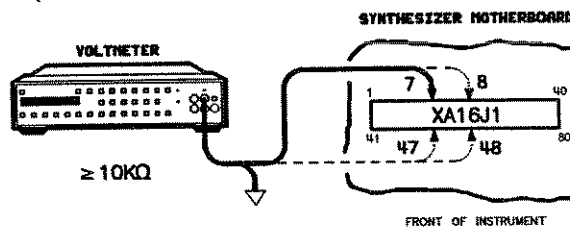

A16.4705 Refer to the disassembly procedures and reinstall the RF deck in the *service position*. Remove the ribbon cables that connect the microcircuits to the RF deck:

Measure the resistance of the +8 Vdc supply to ground (XA16J1-7, 8, 47, and 48 to ground).

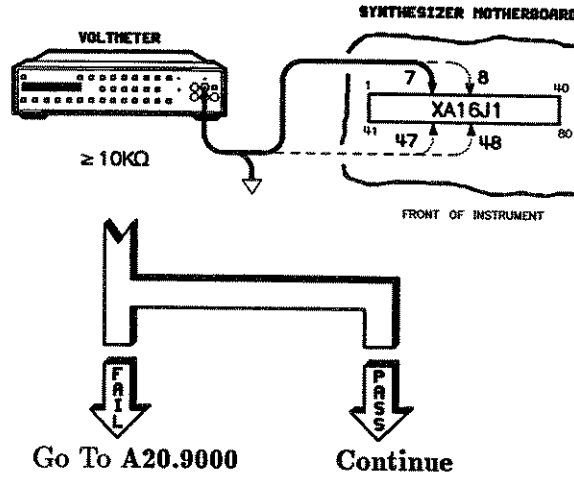

A16.4706 Reconnect the microcircuit ribbon cables one at a time while measuring the resistance of the +8 Vdc supply to ground (XA16J1-7, 8, 47, and 48 to ground). Also check the +8V fuse on A16. If defective, replace it.

Did a microcircuit cause a resistance measurement < 10 kΩ?

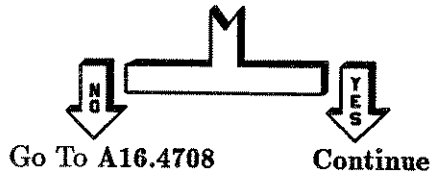

A16.4707

Go to the paragraph indicated to replace the faulty microcircuit.

Microcircuit	Go To Paragraph
A29 amp/filter	RF.2990
A28 amp/multiplier	RF.2890
A26 YO	RF.2690
A24 low band	RF.2490
A31 attenuator	RF.3190
A32 amp/doubler	RF.3290
A33 amp switch	RF.3390

A16.4708

You may have removed the defect in the disassembly process or the problem may be intermittent. Also check the +8V fuse on A16. Replace it if defective. Go to the Troubleshooting Foldout, block 1.

A16.4710

Reinstall the previously removed assemblies one at a time while measuring the resistance of the +8 Vdc supply to ground (XA16J1-7, 8, 47, and 48 to ground). Replace the assembly that causes a resistance measurement of $< 10 \text{ k}\Omega$. If no assembly causes a low resistance measurement, you may have removed the defect in the disassembly process or the problem may be intermittent. Also check the +8V fuse on A16. If defective, replace it. Go to the Troubleshooting Foldout, block 1.

A16.4720 Check the +8V fuse on A16.

Is the fuse defective?

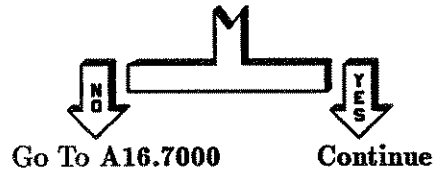

A16.4721 Do the following:

1. Replace the defective fuse.
2. Install A16.
3. Connect the instrument to line power using an isolation transformer.
4. Set the line power switch to ON.

Is the green +8V LED on?

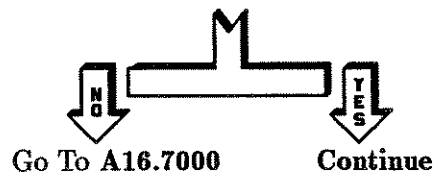

Replacing the fuse seems to have fixed the problem, but this simple solution is suspect. You may want to monitor the instrument for several minutes with the covers on to insure that an intermittent problem does not exist. Go to the Troubleshooting Foldout, block 1.

A16.4730 Refer to the disassembly procedures to remove the rear panel and disconnect ribbon cable W31 from the motherboard. Measure the resistance of the +8 Vdc supply to ground (XA16J1-7, 8, 47, and 48 to ground).

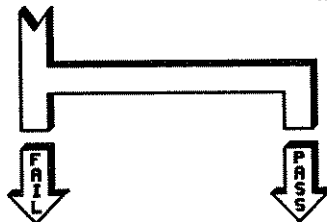
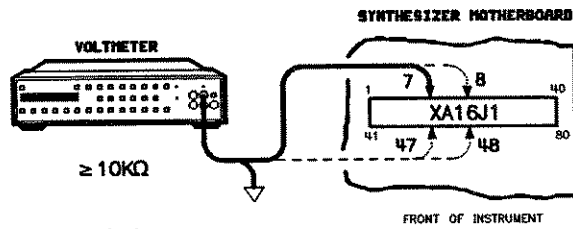

Go To A22.9000 Go To A19.9000

A16.4800 Measure the voltage of the +15 Vdc unregulated supply from A17 to A16 at XA16J1-32, 33, 72, and 73.

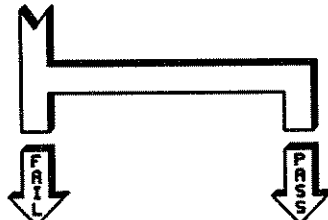
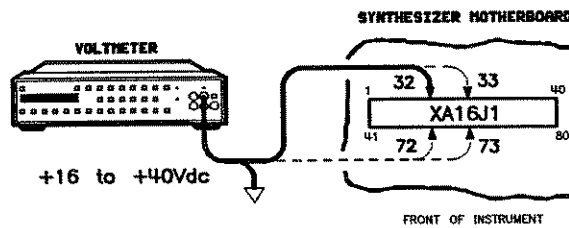

Continue Go To A16.4802

A16.4801 Do the following:

1. Set line power switch to STANDBY.
2. Disconnect the instrument from line power.
3. Wait for all the indicators in the power supply section to go out.
4. Remove A16.
5. Connect the instrument to line power using an isolation transformer.
6. Set the line power switch to ON.

Measure the voltage of the +15 Vdc unregulated supply from A17 to A16 at XA16J1-32, 33, 72, and 73.

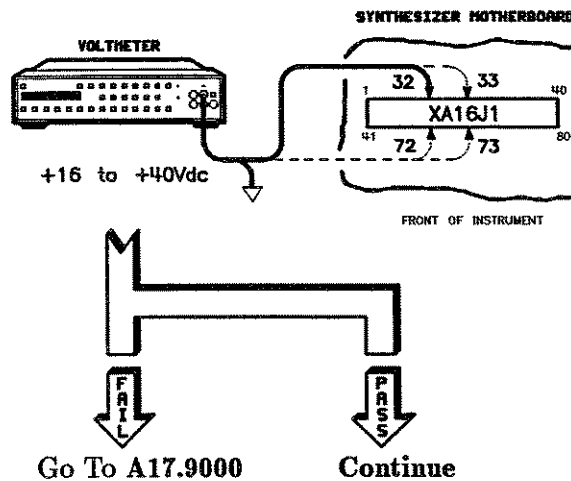

A16.4802 Do the following if not already performed:

1. Set line power switch to STANDBY.
2. Disconnect the instrument from line power.
3. Wait for all the indicators in the power supply section to go out.
4. Remove A16.

Measure the resistance of the +15 Vdc supply to ground (XA16J1-30, 31, 70, and 71 to ground).

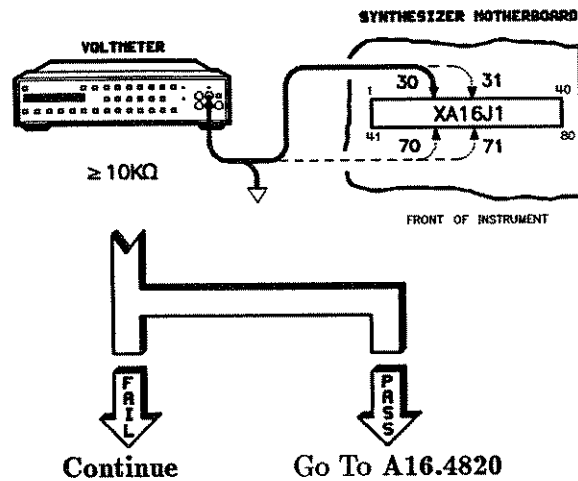

A16.4803 Remove the following assemblies:

- A4 fractional-N.
- A5 YO phase detector.
- A7 reference.
- A9 pulse.
- A11 FM driver.
- A12 SYTM driver.
- A13 YO driver.
- A14 sweep generator.
- A15 microprocessor.
- A6 sampler.

Note



Be sure to disconnect the rigid cable connected to the input of A6 before removing A6. Otherwise damage to the cable, A6 and possibly the filter (FL2) can occur.

Measure the resistance of the +15 Vdc supply to ground (XA16J1-30, 31, 70, and 71 to ground).

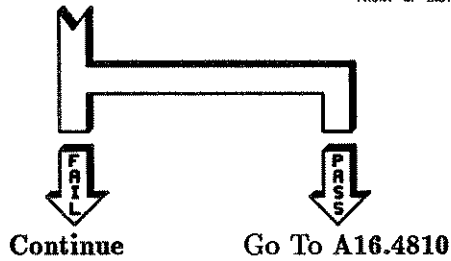
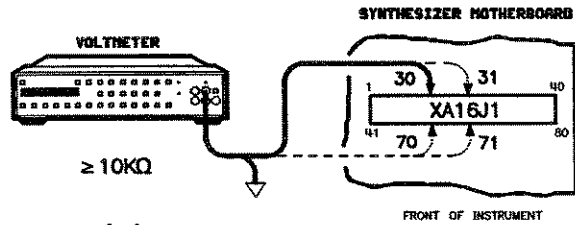

A16.4804 Refer to the disassembly procedures to remove the RF deck.

Measure the resistance of the +15 Vdc supply to ground (XA16J1-30, 31, 70, and 71 to ground).

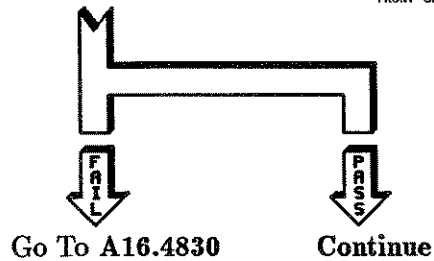
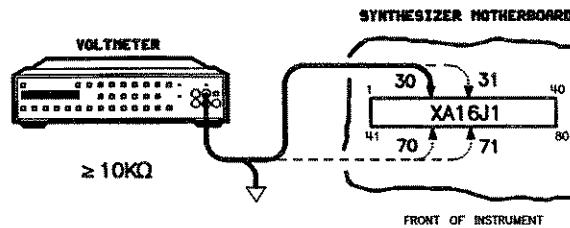

A16.4805 Refer to the disassembly procedures and reinstall the RF deck in the *service position*. Remove the ribbon cables that connect the microcircuits to the RF deck:

Measure the resistance of the +15 Vdc supply to ground (XA16J1-30, 31, 70, and 71 to ground).

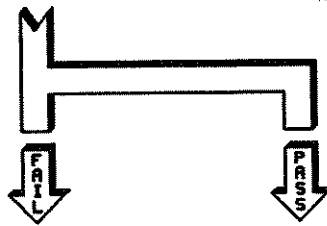
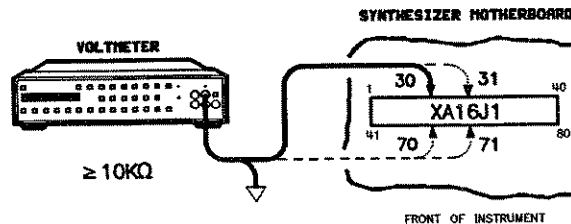

Go To A20.9000

Continue

A16.4806 Reconnect the microcircuit ribbon cables one at a time while measuring the resistance of the +15 Vdc supply to ground (XA16J1-30, 31, 70, and 71 to ground). Also check the +15V fuse on A16. If defective, replace it.

Did a microcircuit cause a resistance measurement of < 10 kΩ?



Go To A16.4808

Continue

A16.4807

Go to the paragraph indicated to replace the faulty microcircuit.

Microcircuit	Go To Paragraph
A29 amp/filter	RF.2990
A28 amp/multiplier	RF.2890
A26 YO	RF.2690
A24 low band	RF.2490
A31 attenuator	RF.3190
A32 amp/doubler	RF.3290
A33 amp switch	RF.3390

A16.4808

You may have removed the defect in the disassembly process or the problem may be intermittent. Also check the +15V fuse on A16. If defective, replace it. Go to Troubleshooting Foldout, block 1.

A16.4810

Reinstall the previously removed assemblies one at a time while measuring the resistance of the +15 Vdc supply to ground (XA16J1-30, 31, 70, and 71 to ground). Replace the assembly that causes a resistance measurement of $< 10 \text{ k}\Omega$. If no assembly causes a low resistance measurement, you may have removed the defect in the disassembly process or the problem may be intermittent. Also check the +15V fuse on A16. If defective, replace it. Go to Troubleshooting Foldout, block 1.

A16.4820 Check the +15V fuse on A16.

Is the fuse defective?

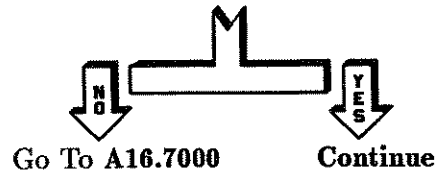

A16.4821 Do the following:

1. Replace the defective fuse.
2. Install A16.
3. Connect the instrument to line power using an isolation transformer.
4. Set the line power switch to ON.

Is the green +15V LED on?

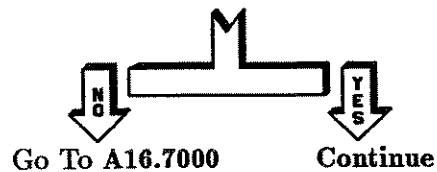

Replacing the fuse seems to have fixed the problem, but this simple solution is suspect. You may want to monitor the instrument for several minutes with the covers on to insure that an intermittent problem does not exist. Go to the Troubleshooting Foldout, block 1.

- A16.4830** Refer to the disassembly procedures to remove the rear panel and disconnect ribbon cable W31 from the motherboard. Measure the resistance of the +15 Vdc supply to ground (XA16J1-30, 31, 70, and 71 to ground).

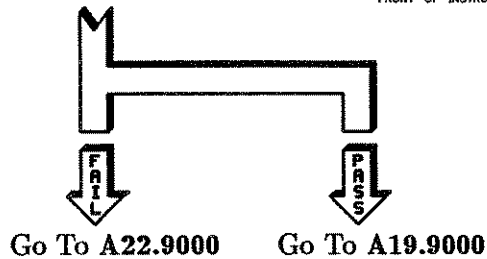
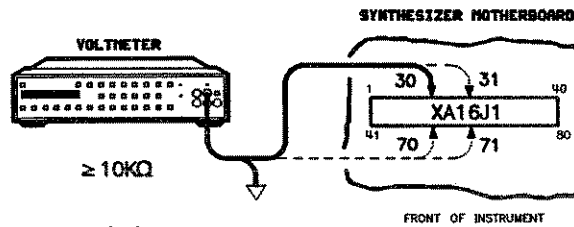

- A16.4900** Do the following:
1. Set line power switch to STANDBY.
 2. Disconnect the ac line power cord.
 3. Wait for all the indicators in the power supply section to go out.
 4. Remove A16.

5. Measure the resistance of the +5 VAUp to ground (XA16J1-76 to ground).

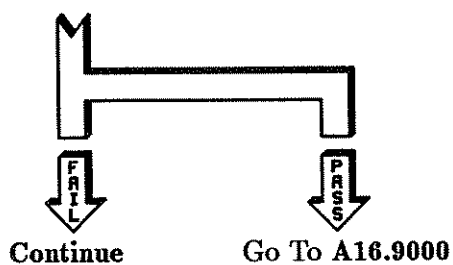
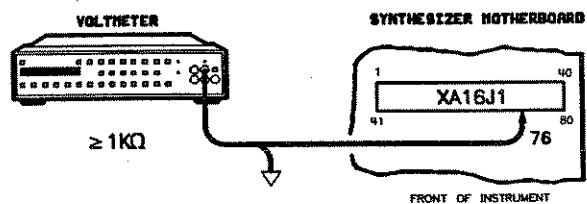

A16.4901 Remove the following assemblies:

- A4 fractional-N.
- A5 YO phase detector.
- A7 reference.
- A9 pulse.
- A11 FM driver.
- A12 SYTM driver.
- A13 YO driver.
- A14 sweep generator.
- A15 microprocessor.

Measure the resistance of the +5 VAUp to ground
(XA16J1-76 to ground).

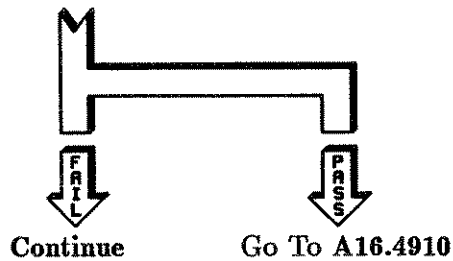
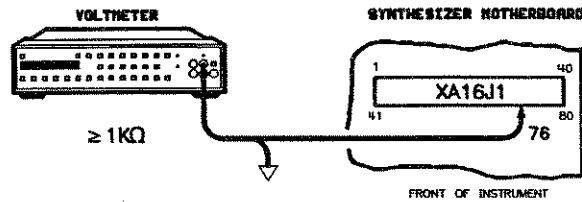

A16.4902 Refer to the disassembly procedures to remove the RF deck. Also remove A6.

Note



Be sure to disconnect the rigid cable connected to the input of A6 before removing A6. Otherwise damage to the cable, A6 and possibly the filter (FL2) can occur.

Measure the resistance of the +5 VAUp to ground (XA16J1-76 to ground).

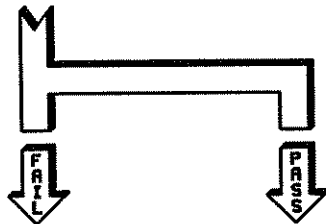
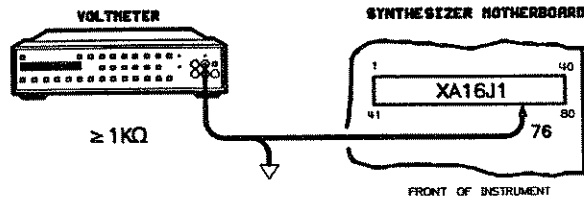

Go To A16.4930

Continue

A16.4905

Refer to the disassembly procedures and reinstall the RF deck in the *service position*. Remove the ribbon cables that connect the microcircuits to the RF deck:

Measure the resistance of the +5 VAUp to ground (XA16J1-76 to ground).

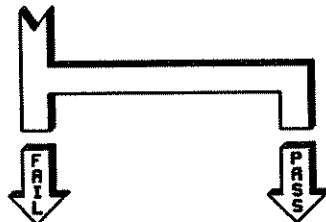
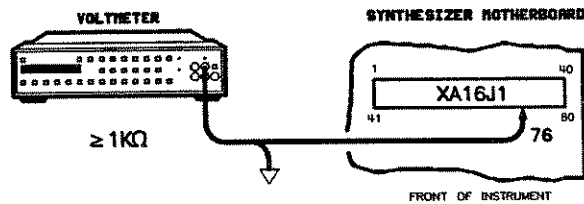

Go To A20.9000

Continue

A16.4906

Reconnect the microcircuit ribbon cables one at a time while measuring the resistance of the +5 VAUp to ground (XA16J1-76 to ground).

Did a microcircuit cause a resistance measurement of $< 1 \text{ k}\Omega$?



Go To A16.4908

Continue

A16.4907

Go to the paragraph indicated to replace the faulty microcircuit.

Microcircuit	Go To Paragraph
A29 amp/filter	RF.2990
A28 amp/multiplier	RF.2890
A26 YO	RF.2690
A24 low band	RF.2490
A31 attenuator	RF.3190
A32 amp/doubler	RF.3290
A33 amp switch	RF.3390

A16.4908

Reinstall A6. Measure the resistance of the +5 VAUp to ground (XA16J1-76 to ground). If A6 causes a resistance measurement of $< 1 \text{ k}\Omega$, go to A6.9000. If not, you may have removed the defect in the disassembly process or the problem may be intermittent. Go to Troubleshooting Foldout, block 1.

A16.4910 Reinstall the previously removed assemblies one at a time while measuring the resistance of the +5 VAUp to ground (XA16J1-76 to ground). Replace the assembly that causes a resistance measurement of $< 1 \text{ k}\Omega$. If no assembly causes a low resistance measurement, you may have removed the defect in the disassembly process or the problem may be intermittent. Go to Troubleshooting Foldout, block 1.

A16.4930 Refer to the disassembly procedures to remove the rear panel and disconnect ribbon cable W31 from the motherboard. Measure the resistance of the +5 VAUp to ground (XA16J1-76 to ground).

Is the resistance $> 1 \text{ k}\Omega$?

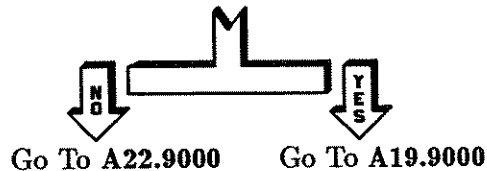

A16.5000

1. Remove A16.
2. Check the +22V plug-in style fuse. Replace the fuse if required.
3. Reinstall A16.

Continue to the next step.

A16.5001 Is the A16 +22V STBY LED on?

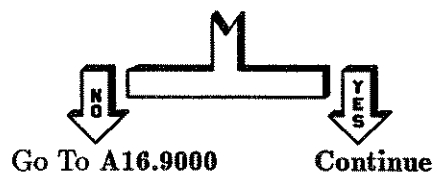

A16.5002 Do the following:

1. Set the line power switch to STANDBY.
2. Remove A16.
3. Connect the instrument to line power using an isolation transformer.
4. Set the line power switch to ON.
5. Measure the voltage of the +22 Vdc supply at XA16J1-4 and 44.

Is the measured voltage between +23 and +55 V dc with less than 2 V dc ripple?

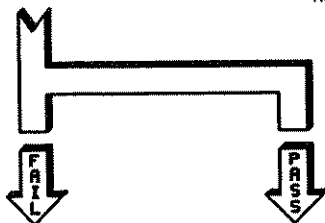
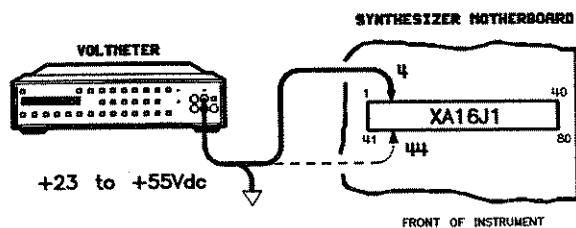

Go To A17.9000

Continue

A16.5003

Reinstall A16. Measure the voltage of the +22 Vdc supply at XA16J1-4 and 44.

Is the measured voltage between +23 and +55 V dc with less than 2 V dc ripple?

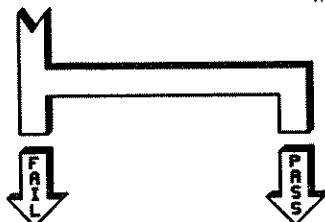
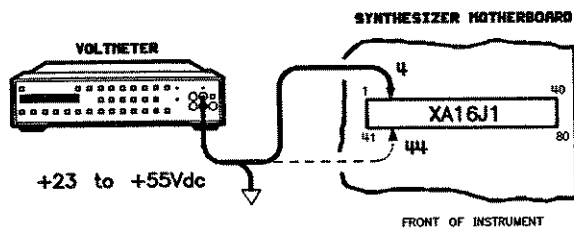

Continue

Go To A16.9000

A16.5004 The problem is most likely A16 (go to A16.9000). However, some chance exists that A17 is unable to supply sufficient current. If replacing A16 does not solve the problem, then replace A17 (go to A17.9000). Then go to Troubleshooting Foldout, block 1.

A16.7000

The most probable fault is A16. However, some chance exists that the supply in question could be loaded by an assembly only when power is applied. If you suspect this type of loading, continue with A16.7001; otherwise, go to A16.9000.

A16.7001

The following is a general procedure. You will have to adapt this procedure to your own situation. If you are unsure how to proceed, or you have questions about safety, do *not* continue with this procedure. Instead, refer the instrument to qualified service personnel.

Warning



When the instrument is connected to ac line power or the A18 high voltage neon indicator is on, there are voltages present that can cause personal injury or death. Only trained, qualified personnel, who are aware of the hazards involved, should perform service on this instrument with its protective covers removed. An isolation transformer must be used during all these procedures.

Observe all safety practices. Remove all jewelry/metal that can short to ground.

The power supply interconnect tables, located in "Special Cases" are useful in determining where to make your measurements.

Continue with A16.7002.

A16.7002

1. Set the line power switch to STANDBY.
2. Remove the following assemblies :
 - A4 fractional-N.
 - A5 YO phase detector.
 - A7 reference.
 - A9 pulse.
 - A11 FM driver.
 - A12 SYTM driver.

- A13 YO driver.
 - A14 sweep generator.
 - A15 microprocessor.
3. Set the line power switch to ON.
 4. Measure the previously-failed voltage.

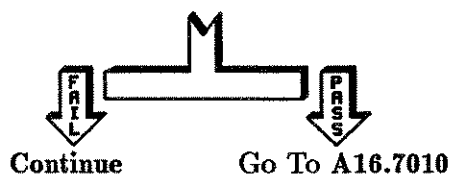

A16.7003

1. Set the line power switch to STANDBY.
2. Replace all previously removed assemblies.
3. Remove A6.

Note



Be sure to disconnect the rigid cable connected to the input of A6 before removing A6. Otherwise damage to the cable, A6, and possibly the filter (FL2) can occur.

4. Set the line power switch to ON.
5. Measure the previously-failed voltage.

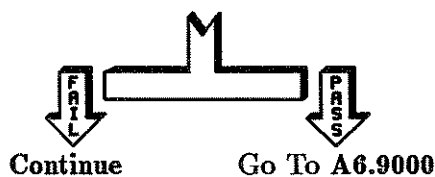

A16.7004

1. Set the line power switch to STANDBY.
2. Replace A6.
3. Remove the RF deck. Refer to the disassembly and replacement procedures as required.
4. Set the line power switch to ON.

5. Measure the previously-failed voltage.

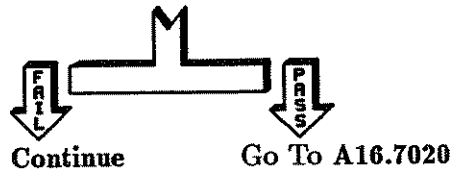

A16.7005

1. Set the line power switch to STANDBY.
2. Disconnect the instrument from ac line power.
3. Replace the RF deck.
4. Remove the front panel assembly. Refer to the disassembly and replacement procedures as required.
5. Disconnect all ribbon cables between the motherboard and the front panel.
6. Reconnect the line power cord.
7. Set the line power switch to ON.
8. Measure the previously-failed voltage.

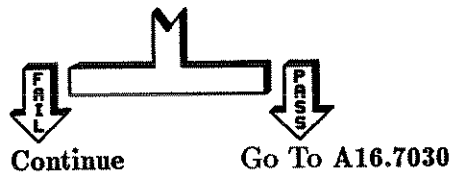

A16.7006

1. Set the line power switch to STANDBY.
2. Disconnect the instrument from ac line power.
3. Wait for all the indicators in the power supply section to go out.
4. Reinstall the front panel.

Warning



When the instrument is connected to ac line power or the A18 high voltage neon indicator is on, there are voltages present that can cause personal injury or death. Only trained, qualified personnel, who are aware of the hazards involved, should perform service on this instrument with its protective covers removed. An isolation transformer must be used during all these procedures.

Observe all safety practices. Remove all jewelry/metal that can short to ground.

5. Remove the rear panel. Refer to the disassembly and replacement procedures as required.
6. Disconnect W31 (the ribbon cable connecting the rear panel interface, A19, to the motherboard, A22).
7. Reinstall the rear panel with the ribbon cable still disconnected.
8. Reconnect the instrument to ac line power.
9. Set the line power switch to ON.
10. Measure the previously-failed voltage.



A16.7007

1. Set the line power switch to STANDBY.
2. Disconnect the instrument from ac line power.
3. Wait for all the indicators in the power supply section to go out.
4. Remove the rear panel. Refer to the disassembly and replacement procedures as required.
5. Reconnect the ribbon cable, W31, between the rear panel interface, A19 and the motherboard, A22.
6. Reinstall the rear panel.

Go To A16.9000

A16.7010

1. Set the line power switch to STANDBY.
2. Reinstall one of the previously removed assemblies.
3. Set the line power switch to ON.
4. Remeasure the voltage. If the voltage now fails, the assembly just installed is faulty.
5. Go to Axx.9000 where xx is the assembly number. For example, if the assembly is A7, then go to A7.9000.
6. Repeat this procedure until the problem has been isolated or until no more assemblies exist.

If no more assemblies exist, go to "Special Cases".

A16.7020

1. Lift the RF deck up into the service position. Refer to the disassembly and replacement procedures as required.
2. Set the line power switch to STANDBY.
3. Remove all ribbon cables connecting the microcircuits to the RF interface board (A20).
4. Set the line power switch to ON.
5. Measure the previously-failed voltage.

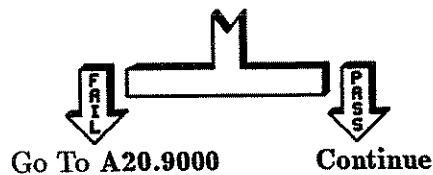
**A16.7021**

1. Lift the RF deck up into the service position. Refer to the disassembly and replacement procedures as required.
2. Set the line power switch to STANDBY.
3. Select a microcircuit, attenuator, or other assembly on the RF deck and reconnect the ribbon cable for that assembly.
4. Set the line power switch to ON.

5. Remeasure the voltage. If the voltage now fails, this assembly is faulty.
6. Go to RF.xx90 where xx is the assembly number. For example, if the assembly is A29, then go to RF.2990.
7. Repeat this procedure until the problem has been isolated or until no more microcircuits exist.

If no more microcircuits exist, go to "Special Cases".

A16.7030

1. Set the line power switch to STANDBY.
2. Disconnect the instrument from ac line power.
3. Reconnect only W2 (the ribbon cable connecting the source module interface assembly, A2, to the motherboard, A22).
4. Reconnect the instrument to ac line power.
5. Set the line power switch to ON.
6. Measure the previously-failed voltage.

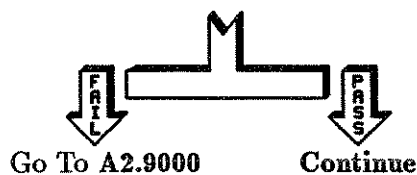

A16.7031

1. Set the line power switch to STANDBY.
2. Disconnect the instrument from ac line power.
3. Reconnect W3 (the ribbon cable connecting the front panel processor, A3, to the motherboard, A22).
4. Disconnect the ribbon cables connecting the front panel processor (A3) to the display (A21) and the keyboard (A1).
5. Reconnect the the instrument to ac line power.
6. Set the line power switch to ON.

7. Measure the previously-failed voltage.

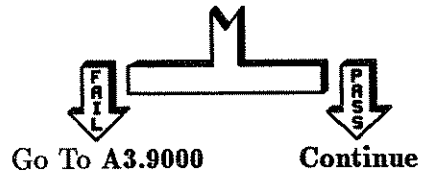

A16.7032

1. Set the line power switch to STANDBY.
2. Disconnect the instrument from ac line power.
3. Reconnect W1 and W4 (the cables connecting the front panel processor, A3, to the display, A21).
4. Reconnect the instrument to ac line power.
5. Set the line power switch to ON.
6. Measure the previously-failed voltage.

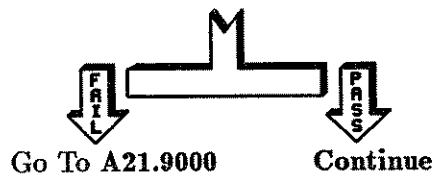

A16.7033

1. Set the line power switch to STANDBY.
2. Disconnect the instrument from ac line power.
3. Reconnect W5 (the ribbon cable connecting the front panel processor, A3, to the keyboard, A1).
4. Reconnect the instrument to ac line power.
5. Set the line power switch to ON.
6. Measure the previously-failed voltage.

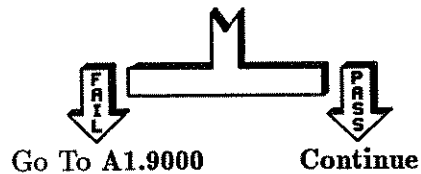

A16.7034 The problem may be intermittent. Go to “Special Cases” if you need additional assistance.

A 16.9000

Replace the A16 assembly.

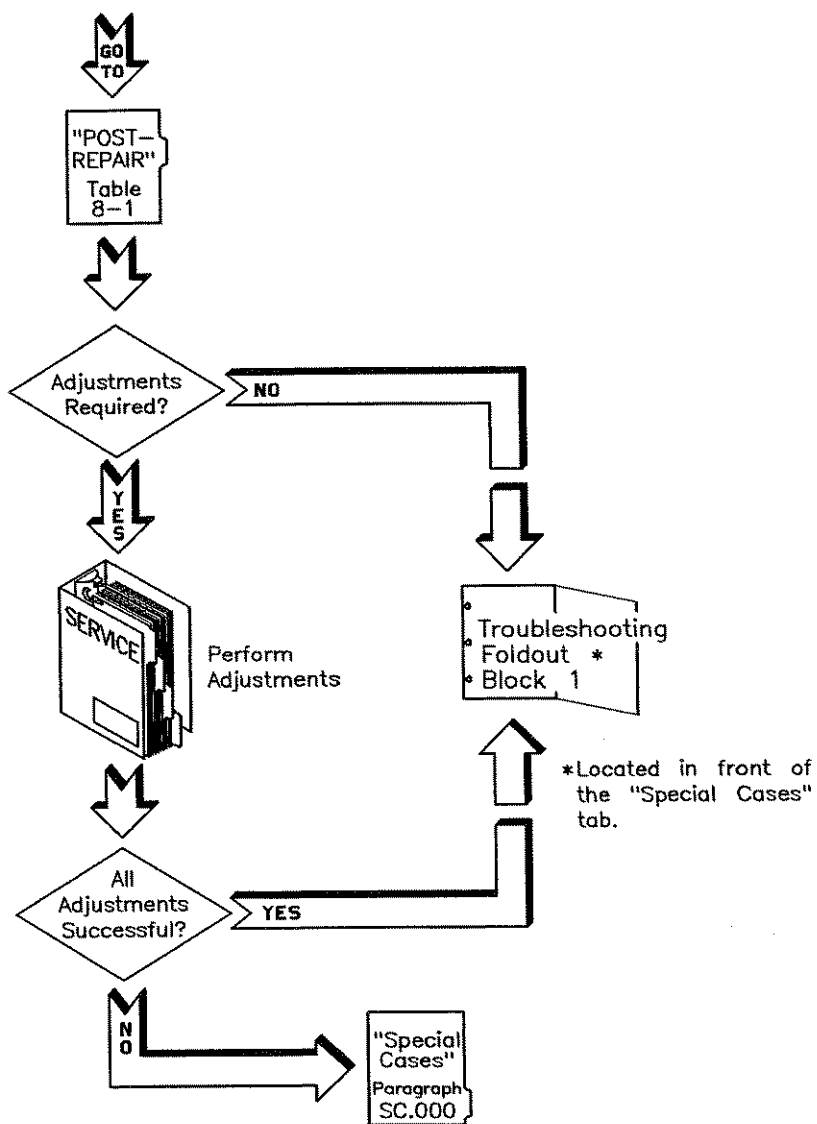

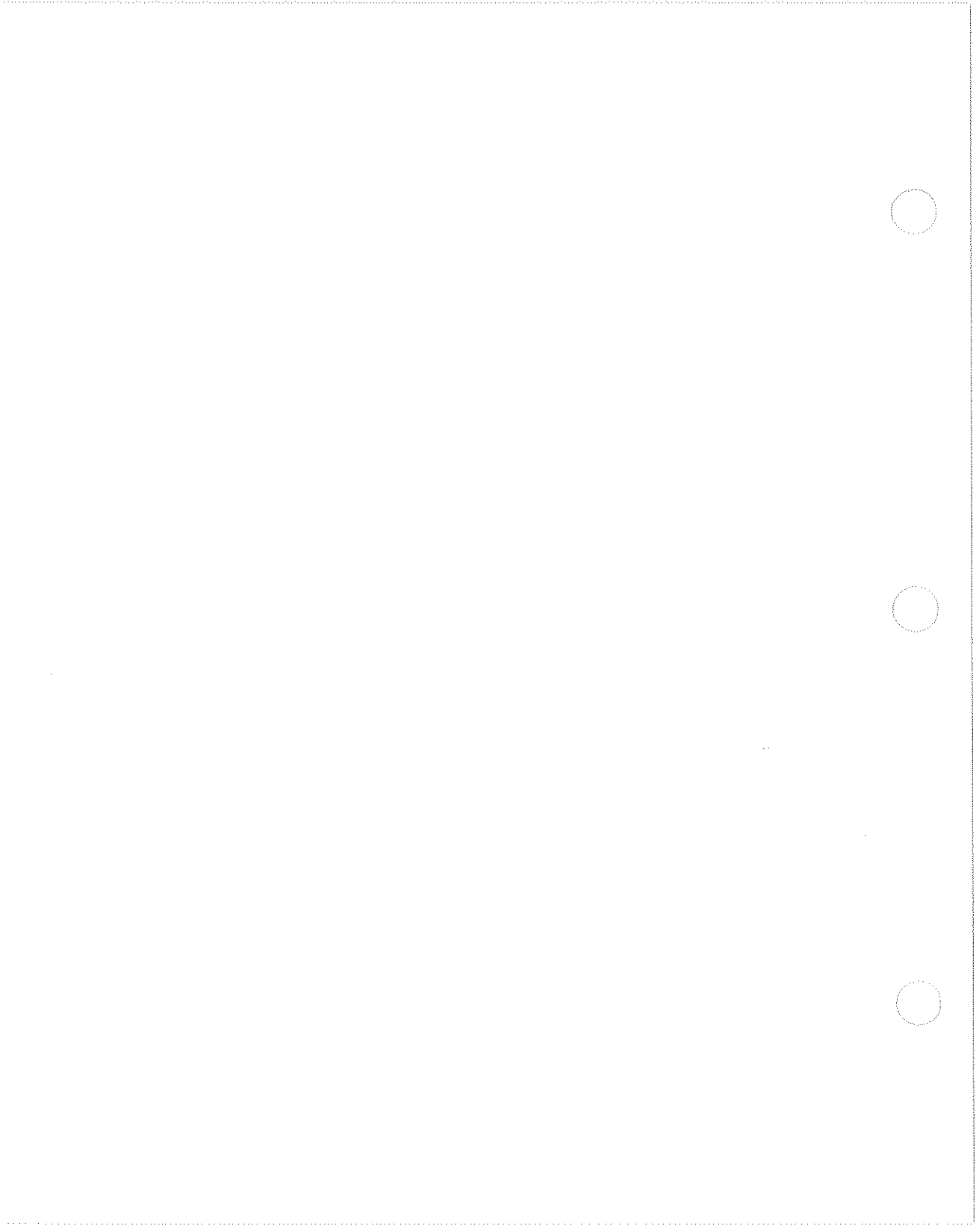

A17 Rectifier/Filter Replacement

A17.000

If you think the problem with your instrument may originate on the A17 assembly, go to “Instrument-Level Troubleshooting.”

A17.9000

Replace the A17 assembly and go to the Troubleshooting Foldout, block 1 (located just prior to the “Special Cases” tab). A17 and A18 are never completely isolated. If replacing A17 does not resolve your problem, try replacing A18.

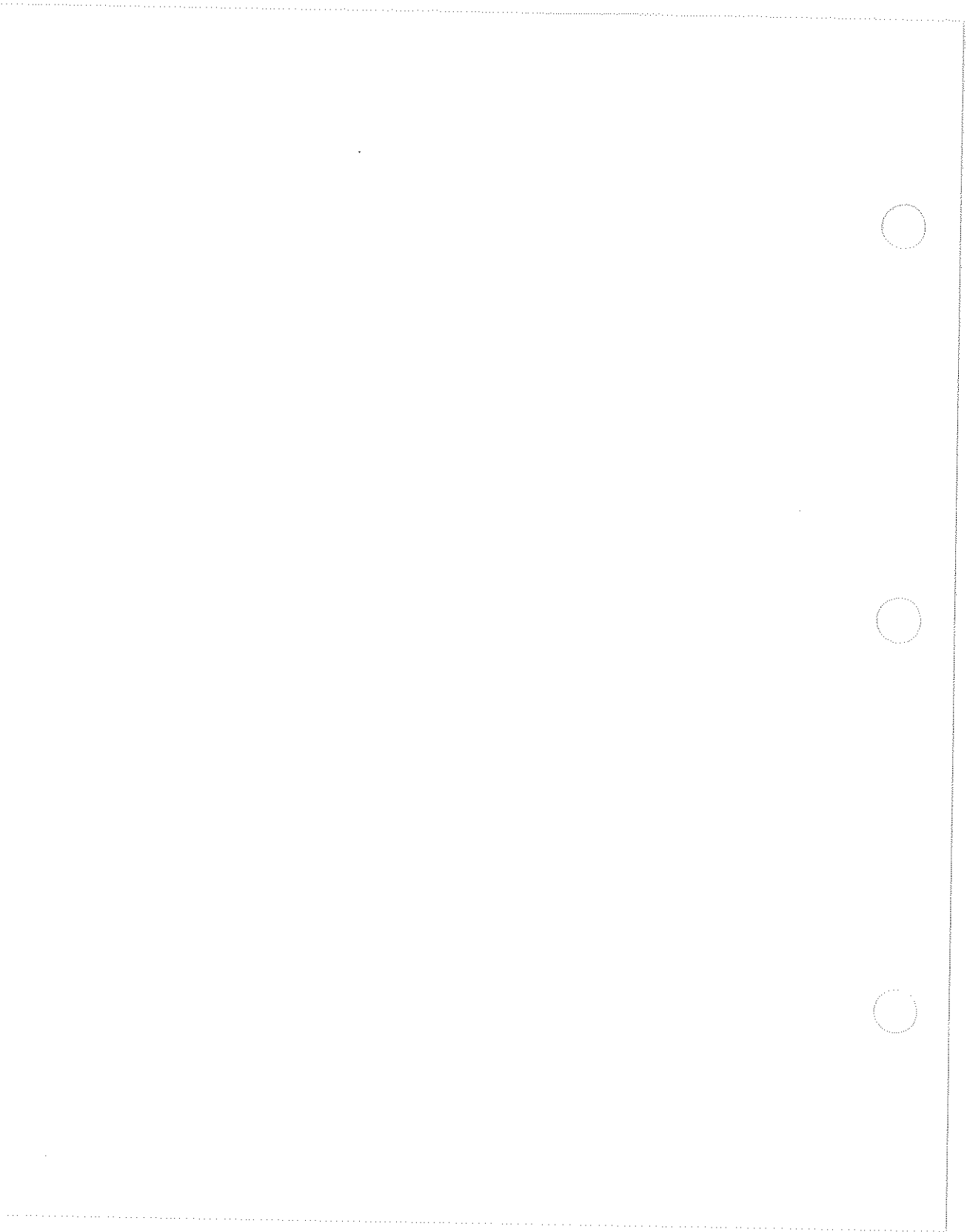

A18 Preregulator Replacement

A18.000

If you think the problem with your instrument may originate on the A18 assembly, go to “Instrument-Level Troubleshooting.”

A18.9000

Replace the A18 assembly and go to the Troubleshooting Foldout, block 1 (located just prior to the “Special Cases” tab). A17 and A18 are never completely isolated. If replacing A18 does not resolve your problem, try replacing A17.



A19 Rear Panel Interface Troubleshooting

A19.000	Message Displayed on Synthesizer	Go to Paragraph
	A19 : Control Latch	A19.100
	A19 : SMI Control Latch	A19.200
	A19 : SMI Sensing Circuit	A19.300
	A19 : Switched STD Supply	A19.9000

A19.100

The A22J8 connector is located at the back of the motherboard.

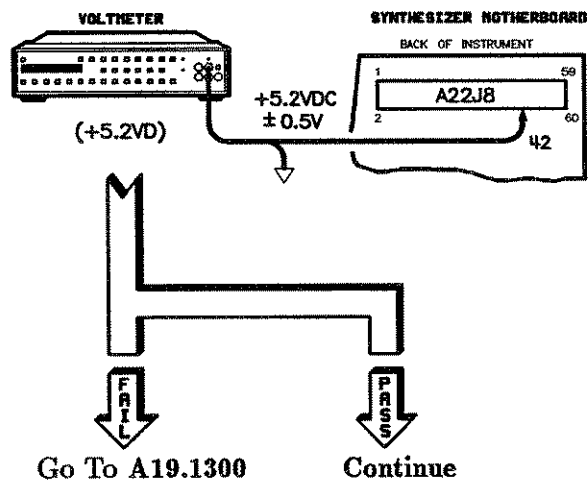

A19.101 Loop self-test #232:

1. Press **PRESET** **SERVICE**.
2. Select **Selftest Menu**.
3. Press **232** **ENTER**.

4. Select **Loop Do Test #232**.

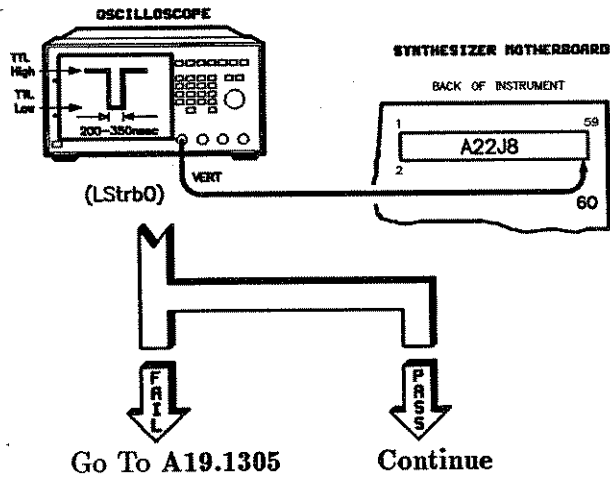

A19.102 Loop self-test #233:

1. Press **PRESET** **SERVICE**.
2. Select **Selftest Menu**.
3. Press **233** **ENTER**.
4. Select **Loop Do Test #233**.

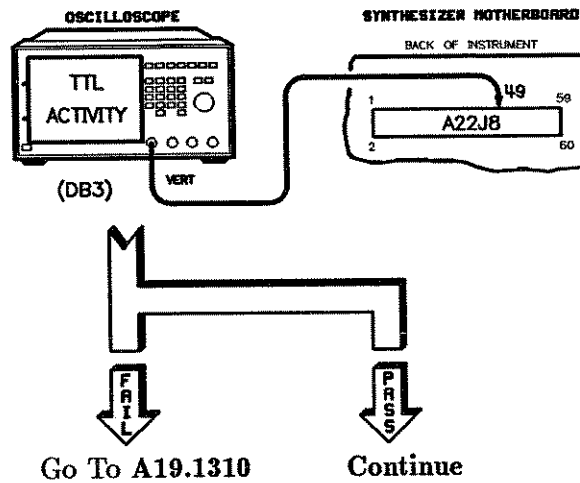

A19.103 Loop self-test #231:

1. Press **PRESET** **SERVICE**.
2. Select **Selftest Menu**.
3. Press **231** **ENTER**.
4. Select **Loop Do Test #231**.

Signal	Location
AB0	A22J8-57
AB1	A22J8-58
AB4	A22J8-55
AB5	A22J8-56
AB6	A22J8-54

If one or more signals do not have *TTL pulses*, the test has failed. If all signals have *TTL pulses*, the test has passed.

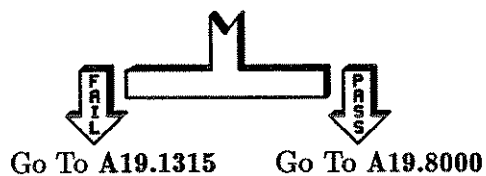

A19.200

Loop self-test #233:

1. Press **PRESET** **SERVICE**.
2. Select **Selftest Menu**.
3. Press **233** **ENTER**.
4. Select **Loop Do Test #233**.

Signal	Location
DB0	A22J8-52
DB1	A22J8-51
DB2	A22J8-50
DB3	A22J8-49
DB4	A22J8-48
DB5	A22J8-47
DB6	A22J8-46
DB7	A22J8-45

If one or more signals do *not* have *TTL pulses*, the test has failed. If *all* signals have *TTL pulses*, the test has passed.

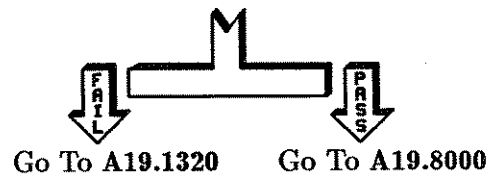

A19.300

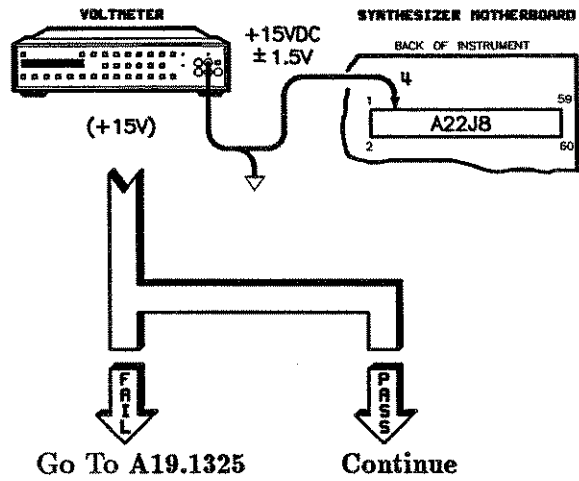

A19.301

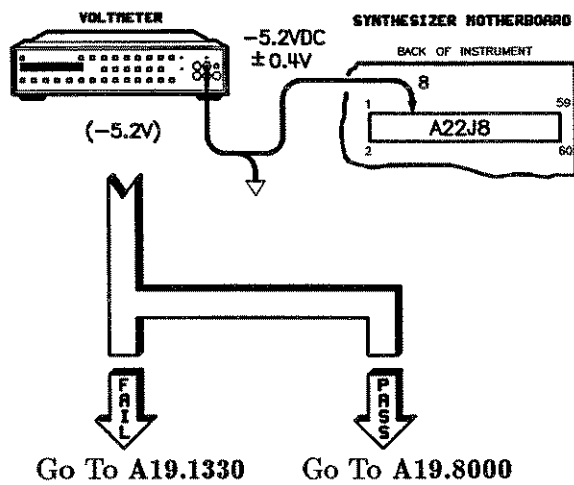

A19.1300

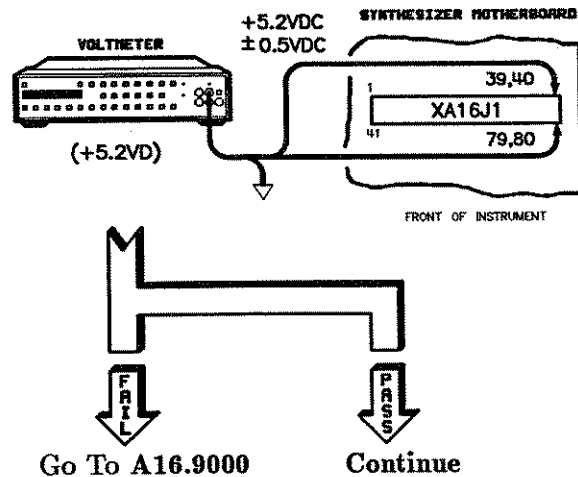

- A19.1301** There is an open on the motherboard between A22J8-42 and A16J-39, 40, 79, or 80. Verify this with an ohmmeter. Is jumpering an acceptable repair?

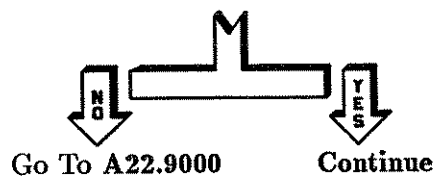

- A19.1302** Install a jumper and go to the Troubleshooting Foldout, block 1 (located just prior to the "Special Cases" tab).

A19.1305

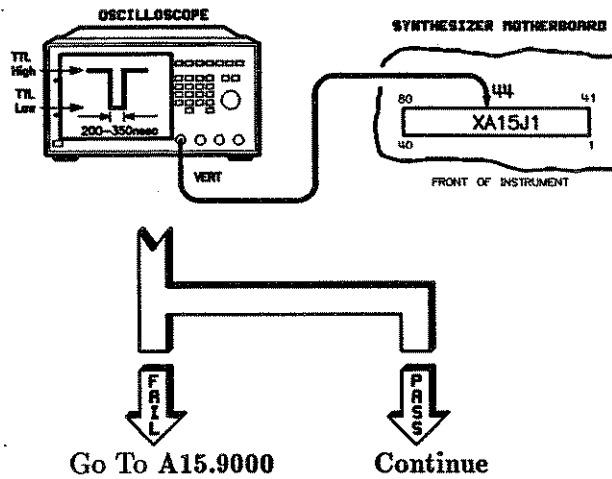

- A19.1306** There is an open on the motherboard between A22J8-60 and XA15J1-44. Verify this with an ohmmeter. Is jumpering an acceptable repair?

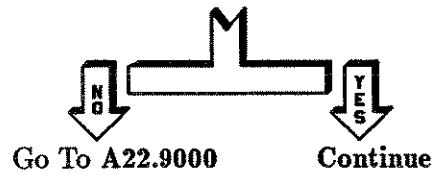

- A19.1307** Install a jumper and go to the Troubleshooting Foldout, block 1 (located just prior to the "Special Cases" tab).

A19.1310

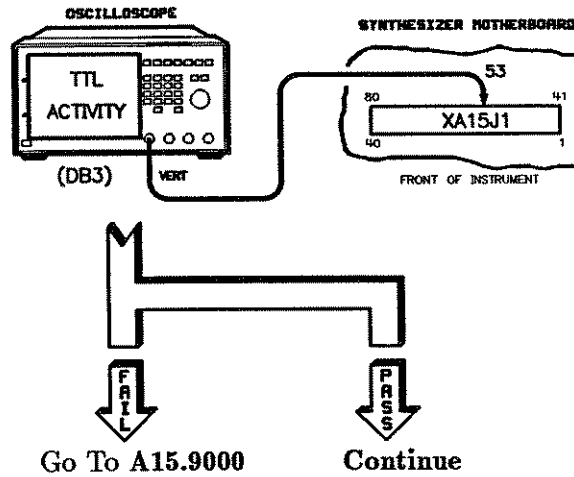

A19.1311 There is an open on the motherboard between A22J8-49 and XA15J1-53. Verify this with an ohmmeter. Is jumpering an acceptable repair?

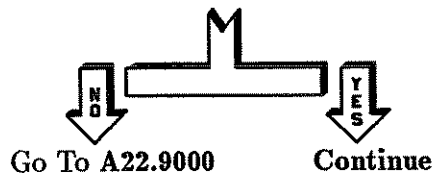

A19.1312 Install a jumper and go to the Troubleshooting Foldout, block 1 (located just prior to the "Special Cases" tab).

A19.1315 Check the following locations for TTL activity.

Signal	Location
AB0	XA15J1-7
AB1	XA15J1-47
AB4	XA15J1-9
AB5	XA15J1-49
AB6	XA15J1-10

If one or more signals do *not* have *TTL pulses*, the test has failed. If *all* signals have *TTL pulses*, the test has passed.

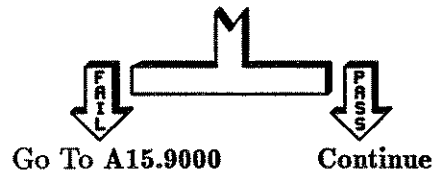

A19.1316 There is an open on the motherboard between XA15J1 and A22J8. Verify this with an ohmmeter. Is jumpering an acceptable repair?

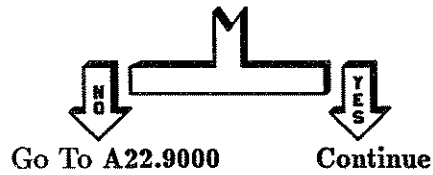

A19.1317 Select the failing signals and install jumpers as required.

Signal	A19 Location	A15 Location
AB0	A22J8-57	XA15J1-7
AB1	A22J8-58	XA15J1-47
AB4	A22J8-55	XA15J1-9
AB5	A22J8-56	XA15J1-49
AB6	A22J8-54	XA15J1-10

After you repair the opens, go to the Troubleshooting Foldout, block 1 (located just prior to the “Special Cases” tab).

A19.1320 Check *all* signals listed below for *TTL pulses* at XA15J1.

Signal	Location
DB0	XA15J1-12
DB1	XA15J1-52
DB2	XA15J1-13
DB3	XA15J1-53
DB4	XA15J1-14
DB5	XA15J1-54
DB6	XA15J1-15
DB7	XA15J1-55

If one or more signals do *not* have *TTL pulses*, the test has failed. If *all* signals have *TTL pulses*, the test has passed.

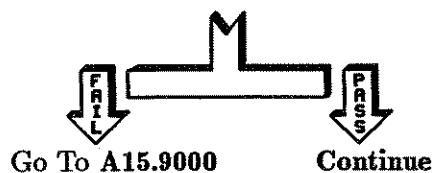

- A19.1321** There is an open on the motherboard data bus between A22J8 and XA15J1. Verify this with an ohmmeter. Is jumpering an acceptable repair?

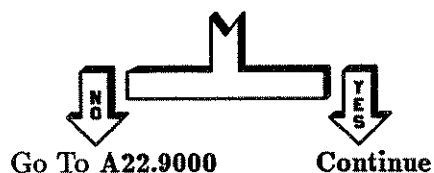

- A19.1322** Select the failing signals and install jumpers as required.

Signal	A19 Location	A15 Location
DB0	A22J8-52	XA15J1-12
DB1	A22J8-51	XA15J1-52
DB2	A22J8-50	XA15J1-13
DB3	A22J8-49	XA15J1-53
DB4	A22J8-48	XA15J1-14
DB5	A22J8-47	XA15J1-54
DB6	A22J8-46	XA15J1-15
DB7	A22J8-45	XA15J1-55

After you repair the opens, go to the Troubleshooting Foldout, block 1 (located just prior to the "Special Cases" tab).

A19.1325

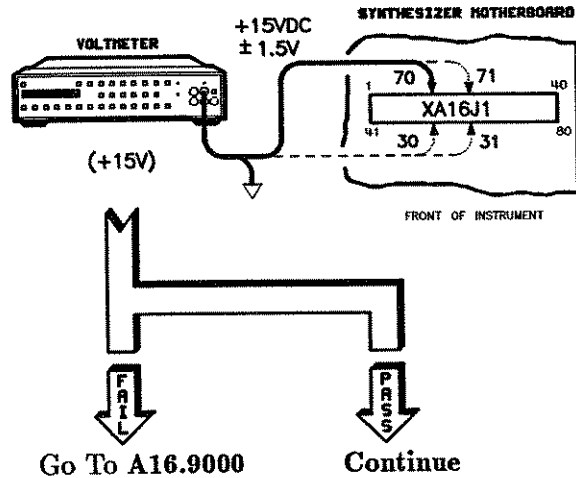

A19.1326 There is an open on the motherboard between A22J8-4 and A16J1-30, 31, 70, or 71. Verify this with an ohmmeter. Is jumpering an acceptable repair?

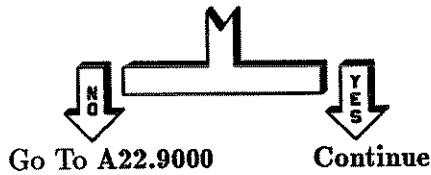

A19.1327 Install a jumper and go to the Troubleshooting Foldout, block 1 (located just prior to the "Special Cases" tab).

A19.1330

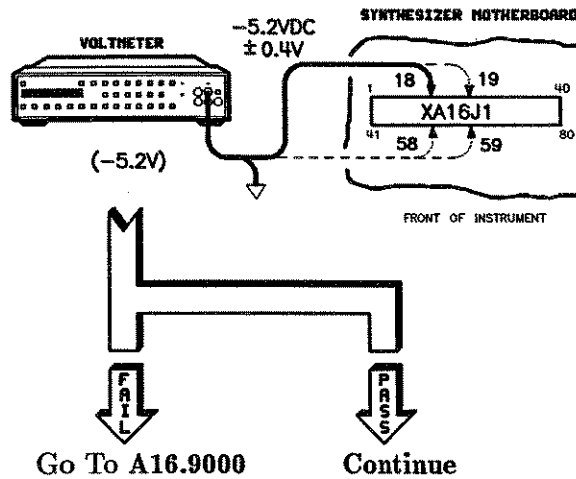

A19.1331 There is an open on the motherboard between A22J8-8 and A16J1-18, 19, 58, or 59. Verify this with an ohmmeter. Is jumpering an acceptable repair?

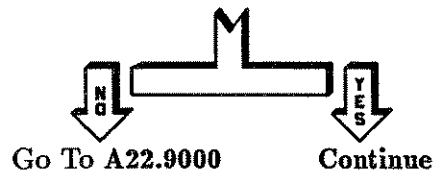

A19.1332 Install a jumper and go to the Troubleshooting Foldout, block 1 (located just prior to the "Special Cases" tab).

A19.8000

Perform the following:

1. Turn the synthesizer off.
2. Unplug the line power cord.
3. Remove the 8 screws that hold the rear panel.
4. Lower the rear panel (there is no need to disconnect it completely).
5. Completely remove W31 (W31 connects A19 to the motherboard).
6. Using an ohmmeter, check W31.

Is W31 Faulty?

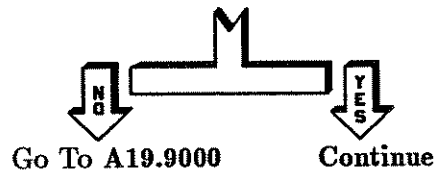

A19.8100

Replace W31. You may also want to replace A19. Then go to the Troubleshooting Foldout, block 1 (located just prior to the "Special Cases" tab).

A19.9000

Replace the A19 assembly.

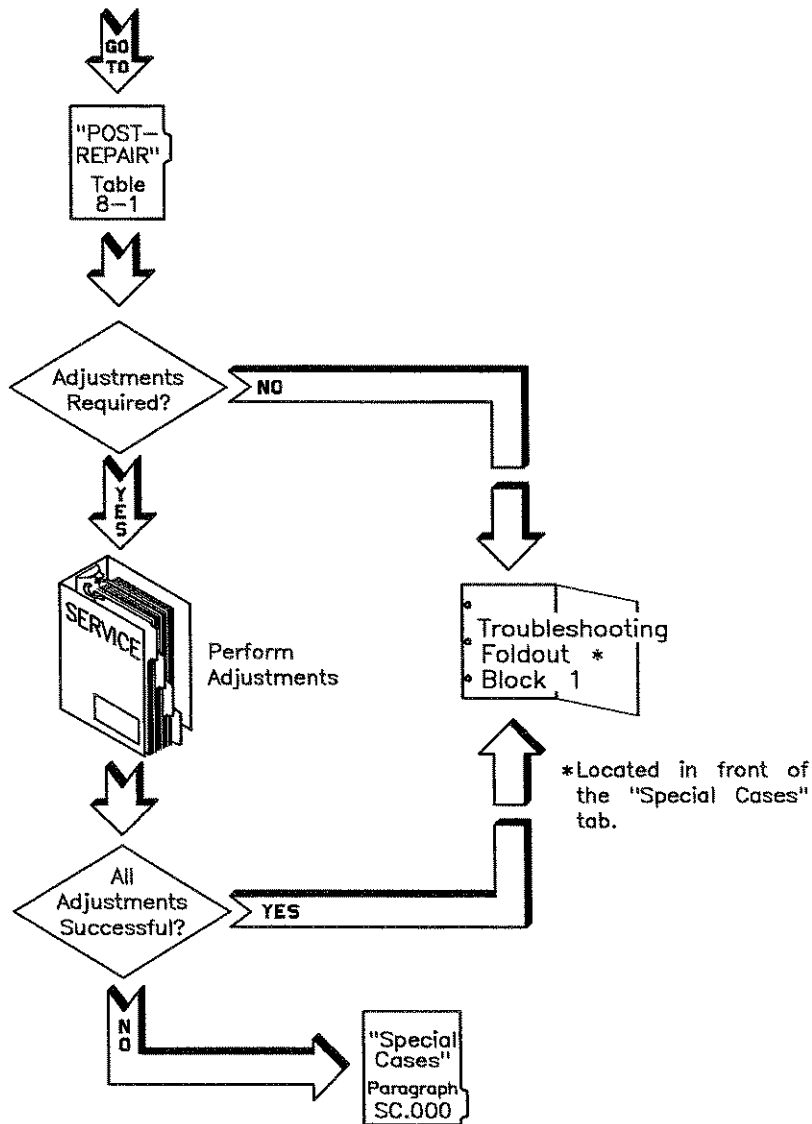

A20 RF Interface Troubleshooting

A20.000

Message Displayed on Synthesizer

**Go to
Paragraph**

A20 : RF Interface +8V

A20.100

A20.100

Perform the following voltage checks. If any measurement fails, the test has failed. If *all* measurements pass, the test has passed.

Name	Limits	Location
+15VDC	+14.7 to +15.5	XA20J1-24, 25, 59, 60
-15VDC	-14.5 to -15.6	XA20J1-26, 61
-40VDC	-39.4 to -40.6	XA20J1-27, 62
+5VA	+5.0 to +5.3	XA20J1-31, 32, 66, 67
+5VD	+5.0 to +5.3	XA20J1-13, 48
+5VAUp	TTL High	XA20J1-68
+8VDC	+7.75 to +8.25	XA20J1-14, 15, 49, 50



Go To A20.120

Continue

A20.101 Perform the following setup:

1. Press **PRESET** **SERVICE**.
2. Select **Selftest Menu**.
3. Press **231** **ENTER**.
4. Select **Loop** (asterisk on).
5. Select **Do Test #231**.
6. Check for TTL activity at the points listed in the following table.
7. If any measurement fails, the test has failed. If *all* measurements pass, the test has passed.
8. To exit the test, select **Loop** (asterisk off).

Signal	Location
AB2	XA20J1-44
AB3	XA20J1-8
AB4	XA20J1-43
AB5	XA20J1-7
AB6	XA20J1-42

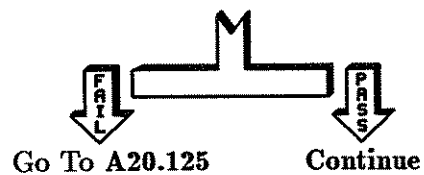

A20.102 Perform the following:

1. Press **PRESET** **SERVICE**.
2. Select **Selftest Menu**.
3. Press **233** **ENTER**.
4. Select **Loop** (asterisk on).
5. Select **Do Test #233**.
6. Check for TTL activity at the points listed in the following table.
7. If any measurement fails, consider the test failed. If *all* measurements pass, consider the test passed.
8. To exit the test, select **Loop** (asterisk off).

Signal	Location
DB0	XA20J1-5
DB1	XA20J1-39
DB2	XA20J1-4
DB3	XA20J1-38
DB4	XA20J1-3
DB5	XA20J1-37

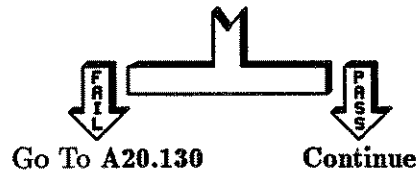

A20.103 Perform the following setup:

1. Press **PRESET** **SERVICE**.
2. Select **Selftest Menu**.
3. Press **232** **ENTER**.
4. Select **Loop** (asterisk on)
5. Select **Do Test #232**.

6. After making the following measurement, to exit the test, select **Loop** (asterisk off).

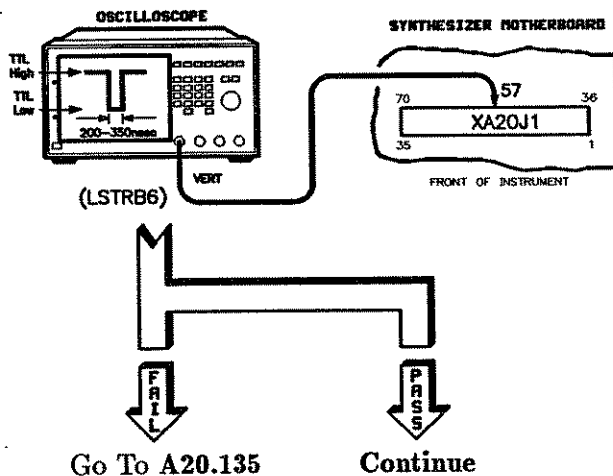

A20.104 Perform the following setup:

1. Press **PRESET** **SERVICE**.
2. Select **Selftest Menu**.
3. Press **255** **ENTER**.
4. Select **Log** (asterisk on).
5. Select **Output Menu** **When to Log Always** (asterisk on).
6. Press **PRIOR**.
7. Select **Do Test #255**.

8. After making the following measurement, to exit the test, select **Loop** (asterisk off).

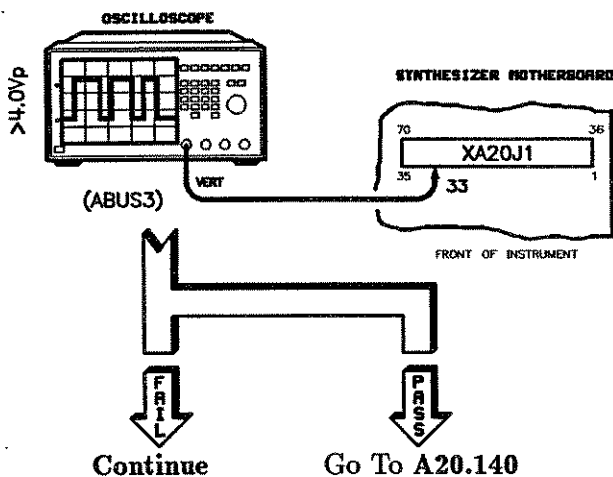

A20.105 Following the disassembly and replacement procedures, lift the RF deck up into the service position. Check the ribbon cable that connects the YO (A26) to the RF interface board (A20). If it is loose, then reseal the cable. Correct any other obvious faults.

Perform the following test:

1. Press **PRESET** **SERVICE**.
2. Select **Selftest Menu**.
3. Press **266** **ENTER**.
4. Select **Do Test #266**.

If the test fails, go to RF.2690. Otherwise, go to the Troubleshooting Foldout, block 1, (located just prior to the "Special Cases" tab).

A20.120 There is an open on the motherboard between the RF interface board (A20) and the post-regulator (A16). Consult the following table to determine the exact location of the open. Verify this with an ohmmeter.

Name	A16 Post Regulator	A20 RF Interface Board
+15VDC	XA16J1-30, 31, 70, 71	XA20J1-24, 25, 59, 60
-15VDC	XA16J1-25, 26, 65, 66	XA20J1-26, 61
-40VDC	XA16J1-22, 62	XA20J1-27, 62
+5VA	XA16J1-13, 14, 53, 54	XA20J1-31, 32, 66, 67
+5VD	XA16J1-39, 40, 79, 80	XA20J1-13, 48
+5VAUp	XA16J1-76	XA20J1-68
+8VDC	XA16J1-6, 7, 8, 46, 47, 48	XA20J1-14, 15, 49, 50

Is jumpering the open an acceptable repair?

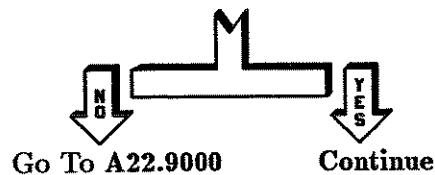

A20.121 Install a jumper. Then go to the Troubleshooting Foldout, block 1, (located just prior to the “Special Cases” tab).

A20.125 There is an open on the motherboard between the RF interface board (A20) and the processor (A15). Consult the following table to determine the exact location of the open. Verify this with an ohmmeter.

Name	A15 Processor	A20 RF Interface Board
AB2	XA15J1-8	XA20J1-44
AB3	XA15J1-48	XA20J1-8
AB4	XA15J1-9	XA20J1-43
AB5	XA15J1-49	XA20J1-7
AB6	XA15J1-10	XA20J1-42

Is jumpering the open an acceptable repair?

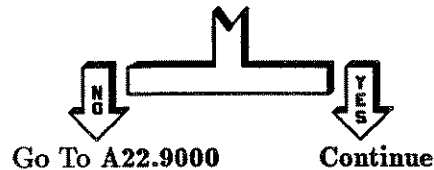

A20.126 Install a jumper. Then go to the Troubleshooting Foldout, block 1, (located just prior to the “Special Cases” tab).

A20.130 There is an open on the motherboard between the RF interface board (A20) and the processor (A15). Consult the following table to determine the exact location of the open.

Name	A15 Processor	A20 RF Interface Board
DB0	XA15J1-12	XA20J1-5
DB1	XA15J1-52	XA20J1-39
DB2	XA15J1-13	XA20J1-4
DB3	XA15J1-53	XA20J1-38
DB4	XA15J1-14	XA20J1-3
DB5	XA15J1-54	XA20J1-37

Is jumpering the open an acceptable repair?

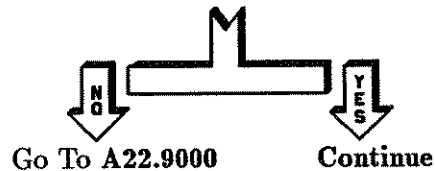

A20.131 Install a jumper. Then go to the Troubleshooting Foldout, block 1, (located just prior to the "Special Cases" tab).

A20.135

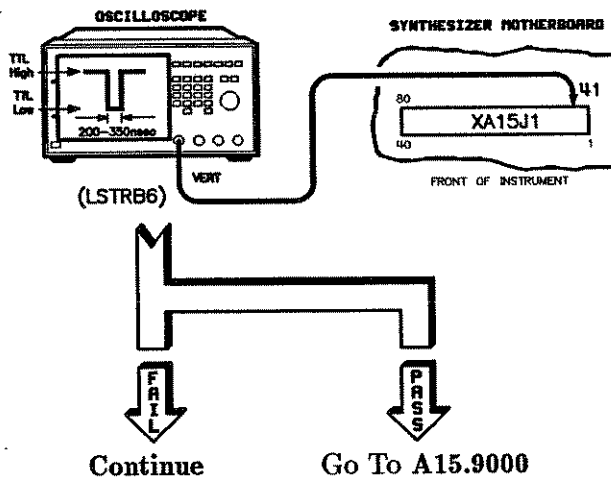

A20.136 There is an open on the motherboard between XA20J1-57 and XA15J1-41. Verify this with an ohmmeter. Is jumpering the open an acceptable repair?

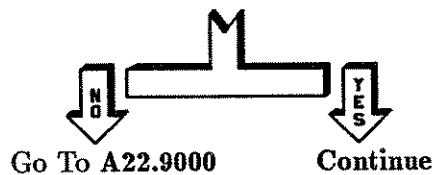

A20.137 Install a jumper. Then go to the Troubleshooting Foldout, block 1, (located just prior to the “Special Cases” tab).

A20.140

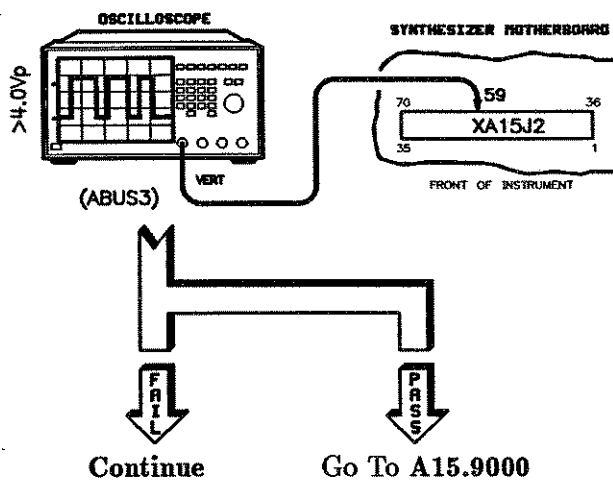

A20.141 There is an open on the motherboard between XA20J1-33 and XA15J2-59. Verify this with an ohmmeter. Is jumpering the open an acceptable repair?

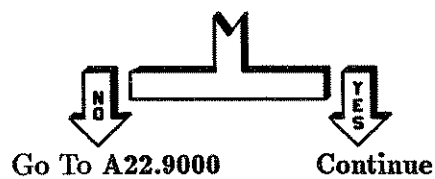

A20.142 Install a jumper. Then go to the Troubleshooting Foldout, block 1, (located just prior to the “Special Cases” tab).

A20.9000

Replace the A20 assembly.

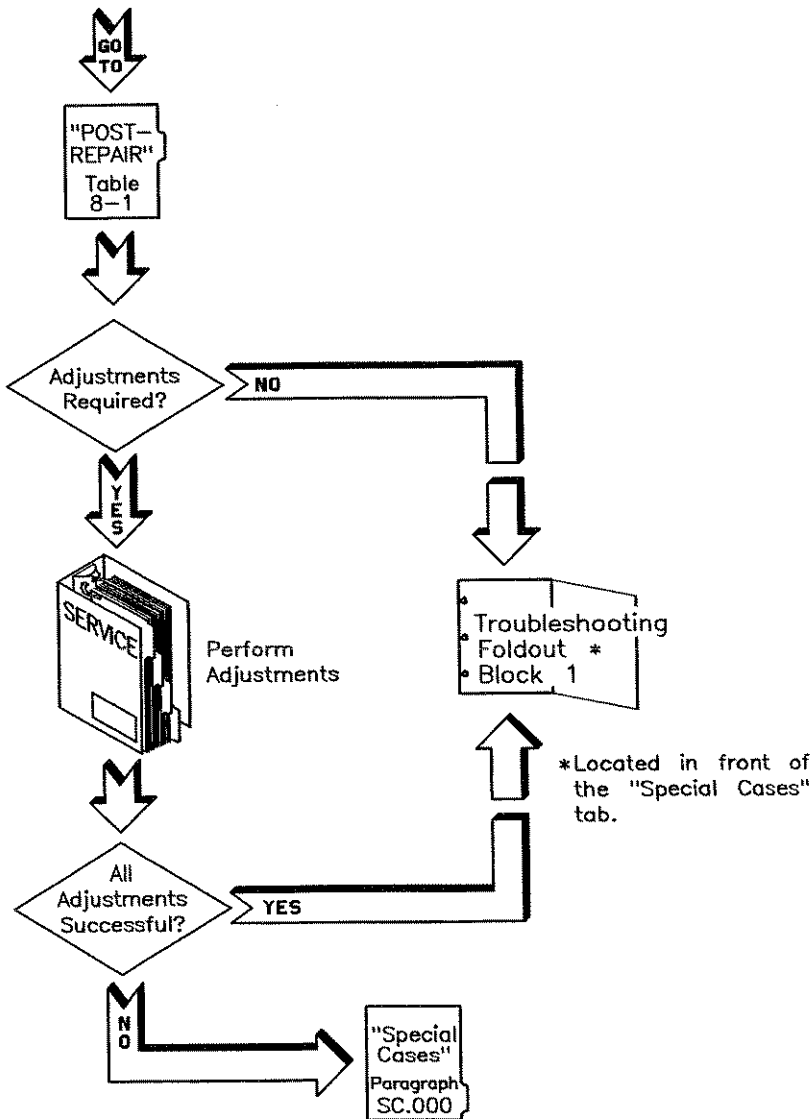

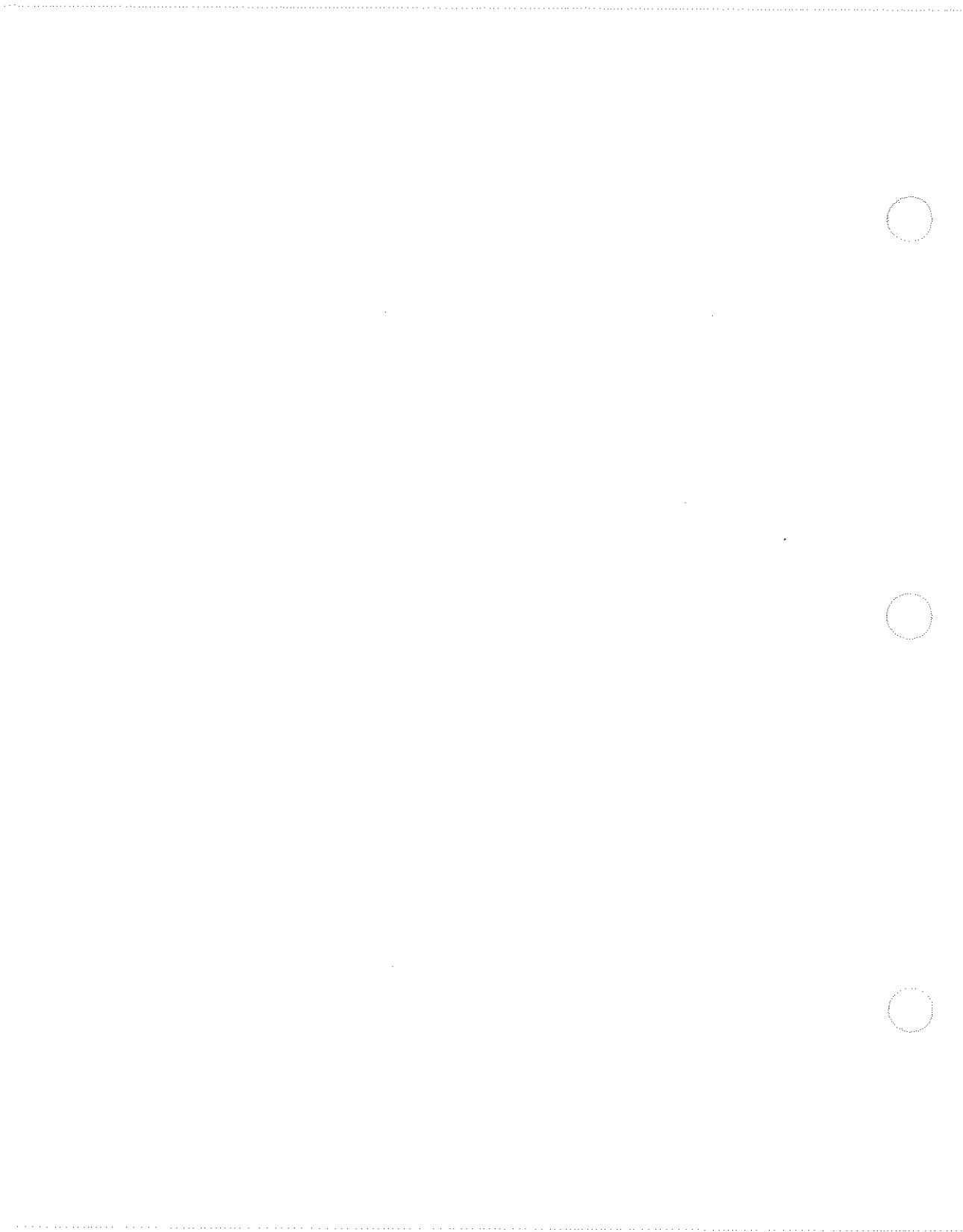

A21 Display Troubleshooting

A21.000

When the full self-tests are run (from the service menu) the display test is not run. Only the display to A3 interface is tested. To test the display, run the following test.

Perform the following key sequence:

1. Press **PRESET** **SERVICE**.
2. Select **Selftest Menu**.
3. Press **257** **ENTER**.
4. Select **Do Test #257**.

You will see a fast-moving cursor moving from side to side and line to line and a walking character set on each line. In this way you can check each segment and the display's logic in presenting the characters.

To exit the test, press **PRESET**.

Note



If the message **POWER SUPPLY FAILURE** or **CHECK INSTRUMENT** appears on the display, this is a sign that the front panel processor (A3) was not able to communicate with the main processor (A15). In this case, the display is not at fault. Go to IIT.000.

A21.9000

Replace the A21 assembly.

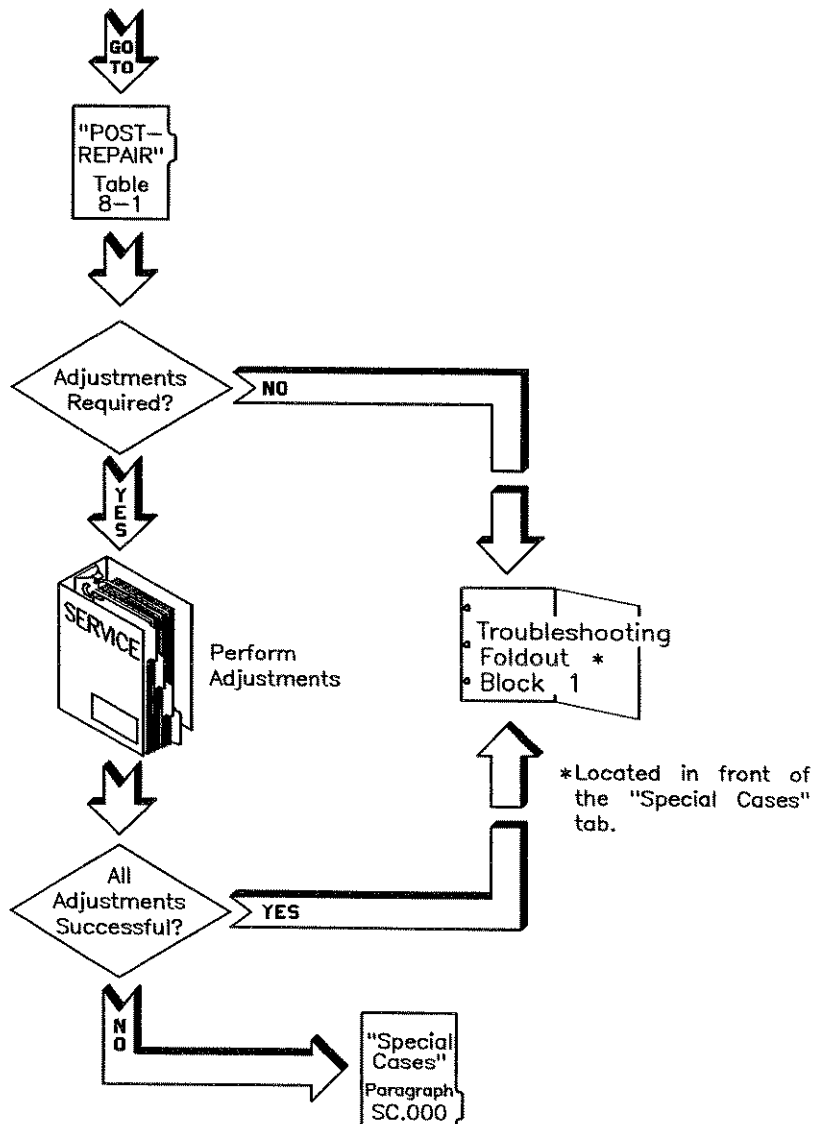

A22 Motherboard Replacement

A22.000

There are no motherboard-specific self-tests. If you think the problem with your instrument may originate on the A22 assembly, go to “Instrument-Level Troubleshooting.”

A22.9000

If you suspect an open trace, verify it with an ohmmeter before replacing A22.

To replace the motherboard assembly, see “Disassembly and Replacement Procedures” in the *Service* manual. Then go to the Troubleshooting Foldout, block 1 (located just prior to the “Special Cases” tab).

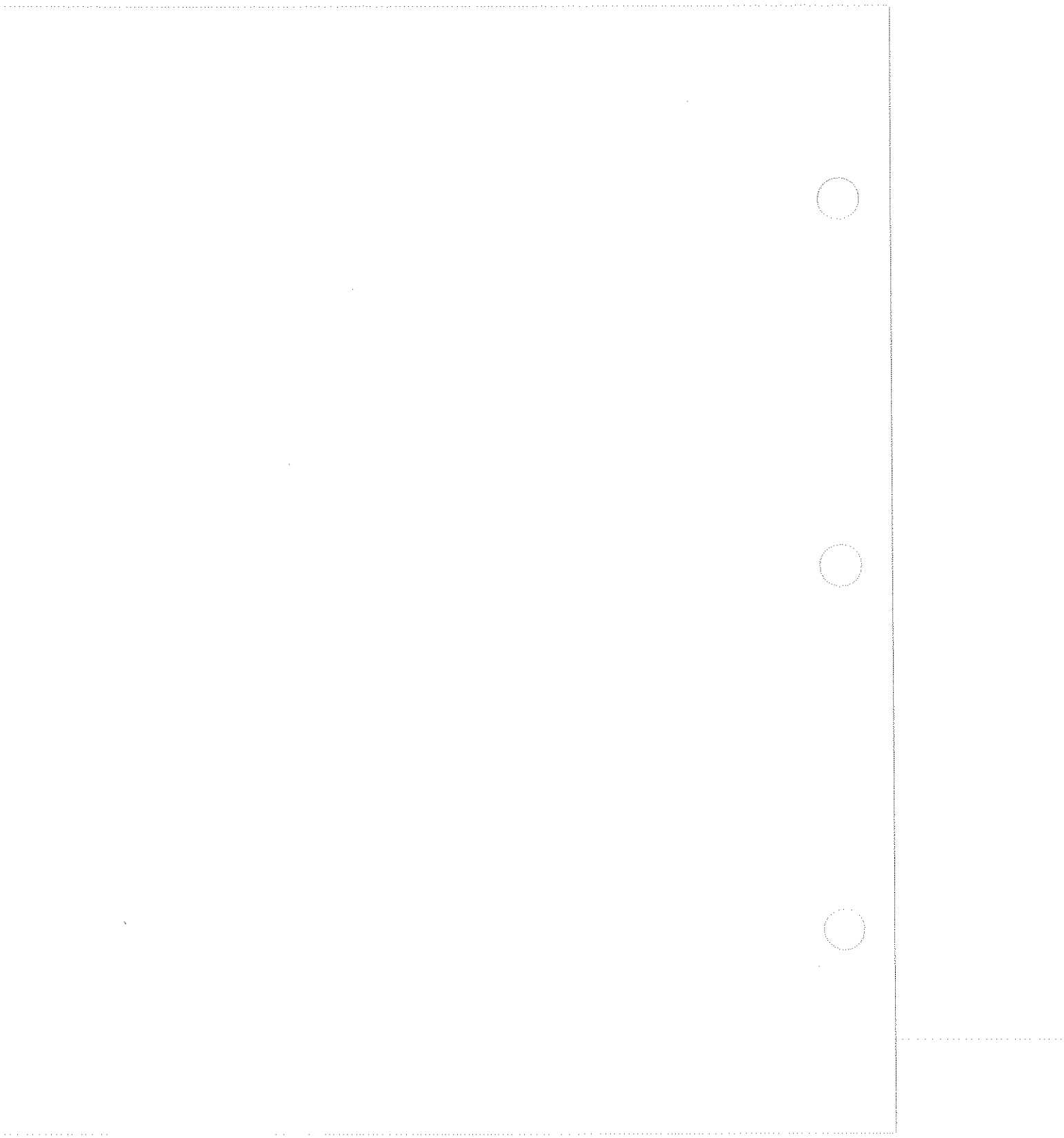

A23 10 MHz Reference Replacement

A23.000

The 10 MHz reference standard is shipped with a cable that is not used. When replacing the reference standard, remove this cable and solder cable W30 from your old reference standard in its place. The disassembly and replacement procedures show this cable.

Go to A23.9000 for A23 replacement.

A23.9000

Replace the A23 assembly.

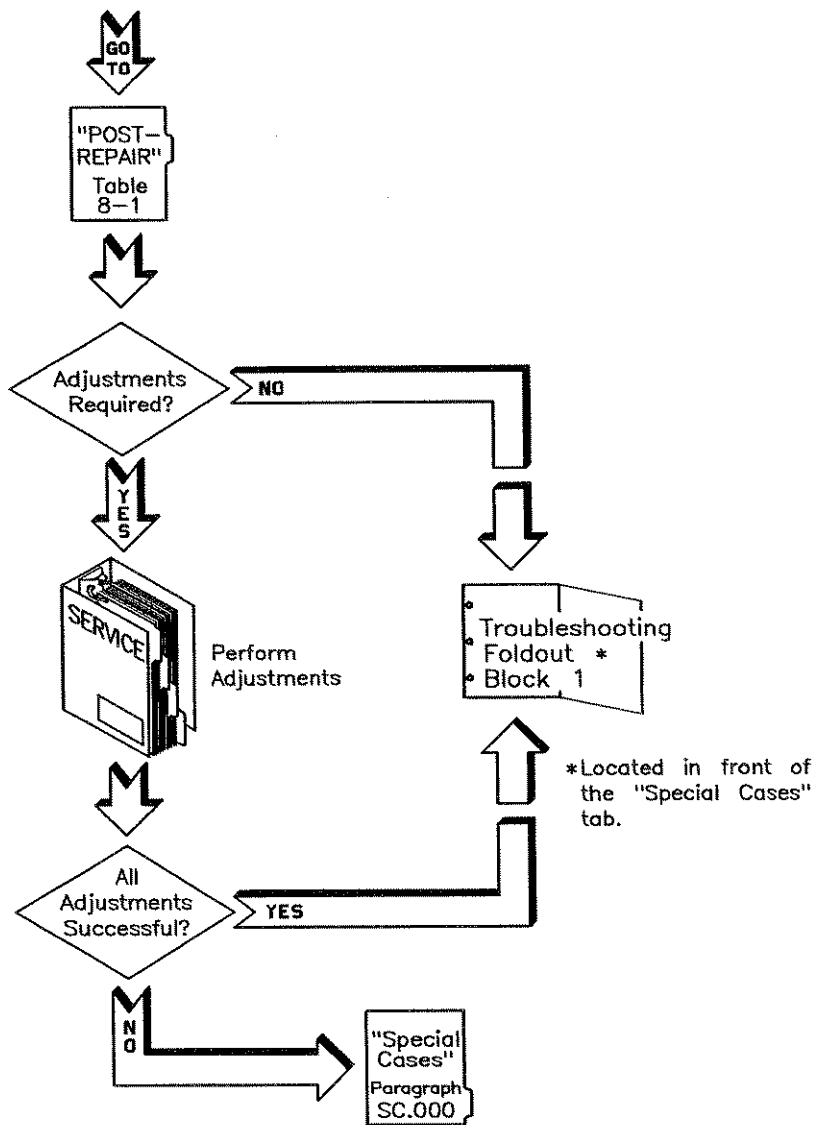

RF Troubleshooting

RF.000	Message Displayed on Synthesizer	Go to Paragraph
	RF : YO Amplifier Bias	RF.100
	RF : LOBAND Tuning Voltage	RF.300
	RF : LOBAND Locked Check	RF.400
	RF : Amp/Multiplier	RF.500
	RF : Amp/Filter	RF.600
	RF : Doubler	RF.700
	RF : LOBAND Output Level	RF.800

RF.100

Following the disassembly and replacement procedures, lift the RF deck up into the service position. Check the ribbon cable that connects the YO (A26) to the RF interface board (A20). If it is loose, then reseal the cable. Correct any other obvious faults.

Perform the following test:

1. Press **PRESET** **SERVICE**.
2. Select **Selftest Menu**.
3. Press **266** **ENTER**.
4. Select **Do Test #266**.

If the test fails, go to RF.2690. Otherwise, go to the Troubleshooting Foldout, block 1 (located just prior to the "Special Cases" tab).

RF.300

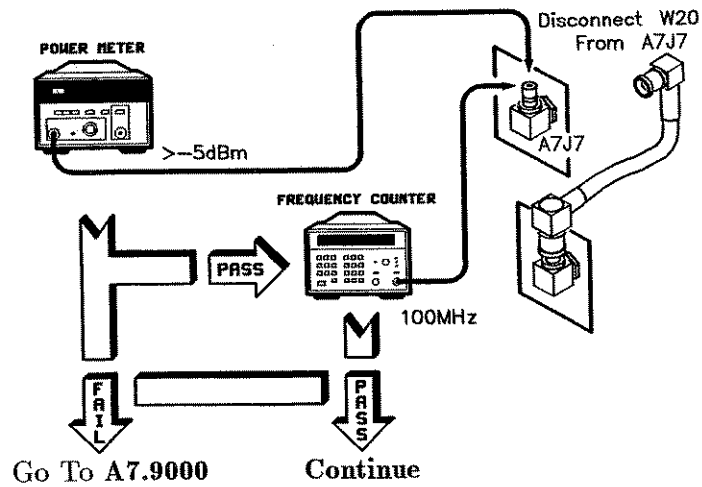

RF.301

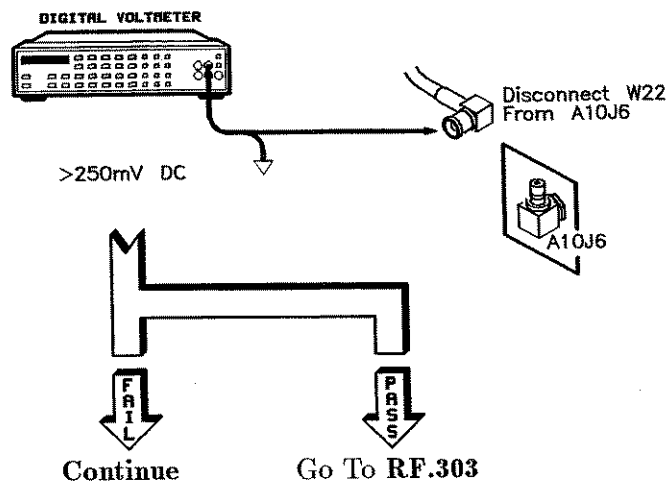

RF.405

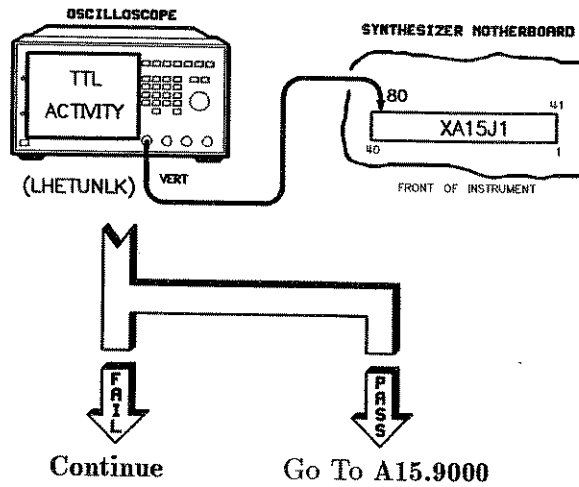

RF.406

There is an open on the motherboard between XA20J1-55 and XA15J1-80. Verify this with an ohmmeter. Is jumpering the open an acceptable repair?

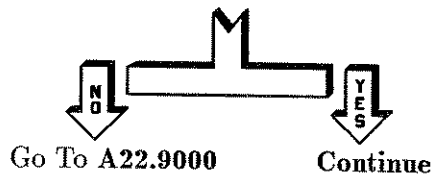

RF.407

Install a jumper. Then go to the Troubleshooting Foldout, block 1 (located just prior to the "Special Cases" tab).

RF.500

Check the ribbon cable that connects the amplifier/multiplier (A28) to the RF interface board (A20). If it is loose, reseal the cable. Correct any other obvious faults.

Perform the following test:

1. Press **PRESET** **SERVICE**.
2. Select **Selftest Menu**.
3. Press **275** **ENTER**.
4. Select **Do Test #275**.

If the test fails, go to RF.2890. Otherwise go to the Troubleshooting Foldout, block 1 (located just prior to the "Special Cases" tab).

RF.600

Check the ribbon cable that connects the amplifier/filter (A29) to the RF interface board (A20). If it is loose, reseal the cable. Correct any other obvious faults.

Perform the following test:

1. Press **PRESET** **SERVICE**.
2. Select **Selftest Menu**.
3. Press **276** **ENTER**.
4. Select **Do Test #276**.

If the test fails, go to RF.2990. Otherwise go to the Troubleshooting Foldout, block 1 (located just prior to the "Special Cases" tab).

RF.700

Using the disassembly and replacement procedures, lift the RF deck into the service position. Check the ribbon cable that connects the doubler (A32) to the RF interface board (A20). If it is loose, reseal the cable. Correct any other obvious physical faults.

Perform the following test:

1. Press **PRESET** **SERVICE**.
2. Select **Selftest Menu**.
3. Press **272** **ENTER**.
4. Select **Do Test #272**.

If the test fails, go to RF.3290. Otherwise, go to the Troubleshooting Foldout, block 1 (located just prior to the "Special Cases" tab).

RF.800

Using the disassembly and replacement procedures, lift the RF deck into the service position. Check the ribbon cable that connects the low band assembly, A24, to the RF interface board, A20. If it is loose, reseal the cable. Correct any other obvious physical faults.

1. Press **PRESET** **SERVICE**.
2. Select **Selftest Menu**.
3. Press **270** **ENTER**.
4. Select **Do Test #270**.



RF.801

Do the following:

1. Set the line power switch to STANDBY.
2. Disconnect W50 from A41.
3. Set the line power switch to ON.
4. Press **PRESET** **SERVICE**.
5. Select **Tools Menu ViewHdwr Menu Y0 Freq/Harm**.
6. Press **CW**.
7. Press **10** **MHz**.

Use the RPG knob to vary the CW frequency over a range of 10 MHz to 1.99 GHz. Measure the power and frequency over this range as shown in the following figure.

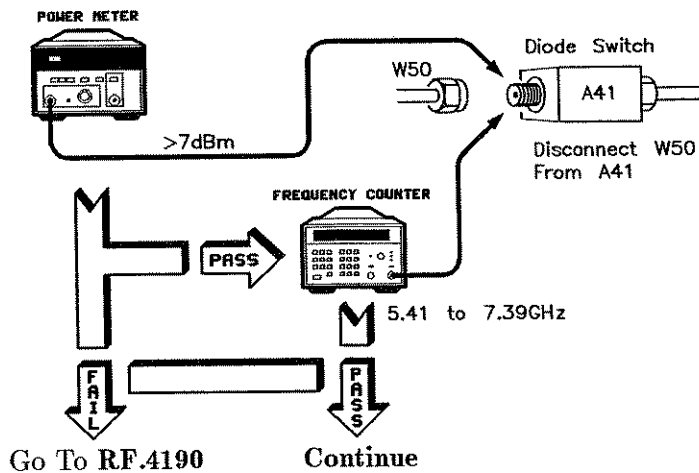

RF.802 Do the following:

1. Reconnect W50 to A41.
2. Press **PRESET** **CW**.
3. Measure the DC voltage at 100 MHz, 500 MHz, 1 GHz, and 2 GHz.

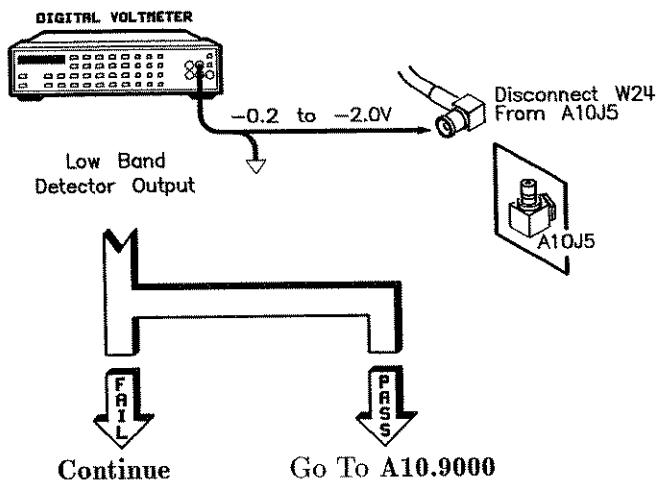

RF.803 Measure the DC voltage at 100 MHz, 500 MHz, 1 GHz, and 1.9 GHz.

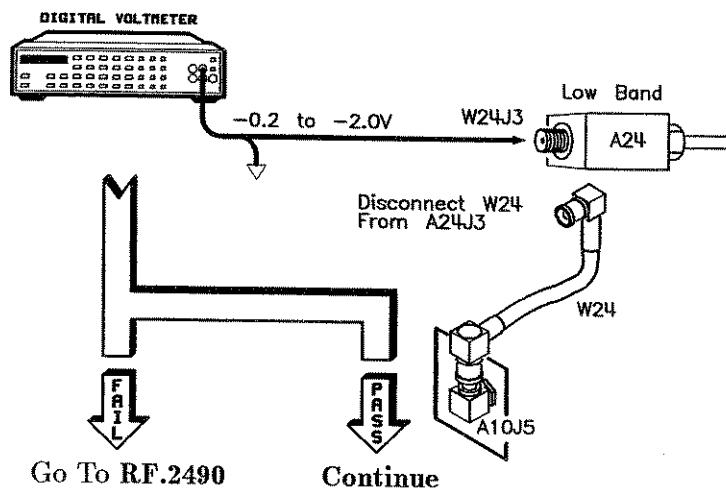

RF.804 Replace W24 and to to the Troubleshooting Foldout, block 1 (located just prior to the "Special Cases" tab).

Microcircuit Assembly Replacement

RF.2490 The low band assembly (A24) is the most-likely failure. There is a small chance that A20 has failed.

Has the low band assembly (A24) been replaced?

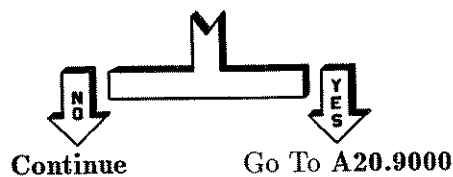

RF.2491 Replace the low band assembly, A24, using the disassembly and replacement procedures in the *Service* manual. Then perform the appropriate adjustments and performance tests and restart troubleshooting.

RF.2690 The YO (A26) is the most-likely failure. However, there is a small chance that the failure is A20.

Has the YO (A26) been replaced?

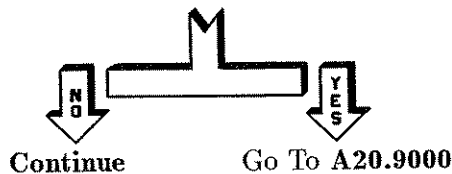

RF.2691 Replace the YO, A26, using the disassembly and replacement procedures in the *Service* manual. Then perform the appropriate adjustments and performance tests and restart troubleshooting.

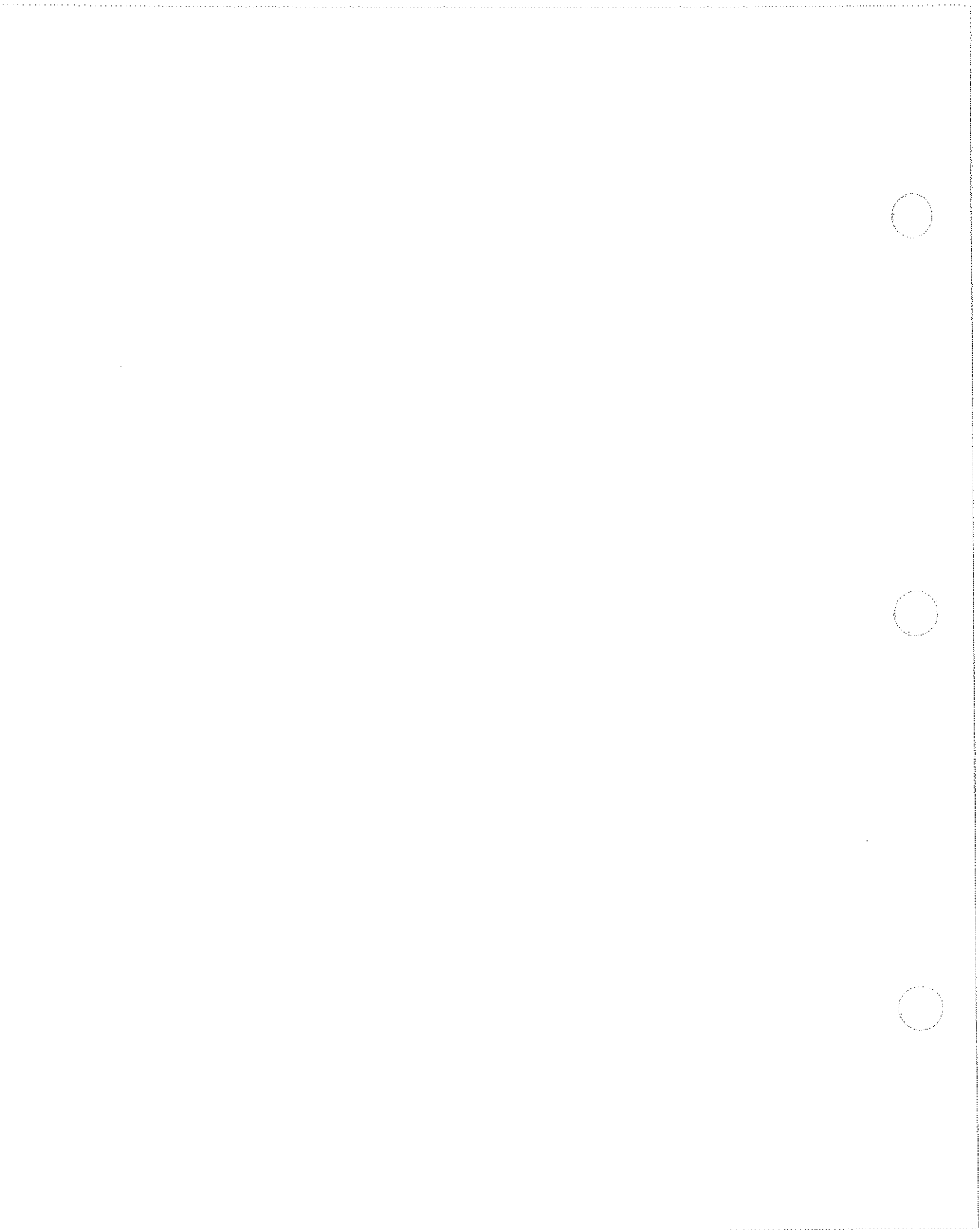

- RF.3090** The A30 bridge detector has failed. Replace it and perform the appropriate adjustments and performance tests.
- RF.3290** Replace the amp/doubler, A32, using the disassembly and replacement procedures in the *Service* manual. Perform the appropriate adjustments and restart troubleshooting.
- RF.3890** Replace the Am modulator, A38, using the disassembly and replacement procedures in the *Service* manual. Perform the appropriate adjustments and restart troubleshooting.
- RF.3990** Replace the directional coupler, A39, using the disassembly and replacement procedures in the *Service* manual. Perform the appropriate adjustments and restart troubleshooting.
- RF.4190** A41 is the most likely failure. However, there is a small chance that the problem is with the switching voltage on the DC feed on A41. At 1.9 GHz the voltage should be < -4 V; at 2 GHz the voltage should be $> +4$ V. Replace the diode switch, A41, using the disassembly and replacement procedures in the *Service* manual. Perform the appropriate adjustments and restart troubleshooting.

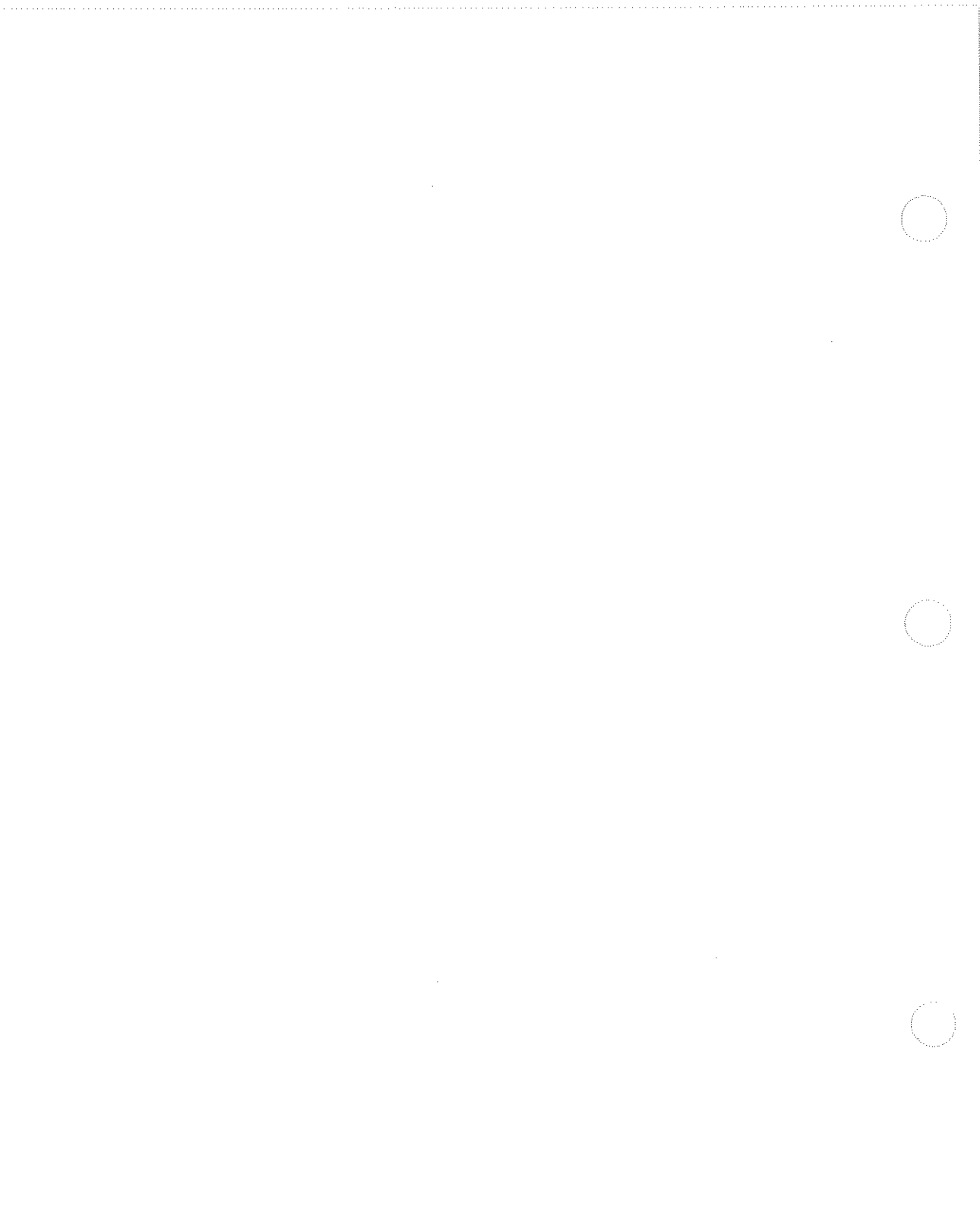

System Troubleshooting

SYS.000	Message Displayed on Synthesizer	Go to Paragraph
	SYS : YO Loop Locking	SYS.100
	SYS : LBAND Modulators	SYS.200
	SYS : LBAND Leveling	SYS.300
	SYS : HBAND Leveling	SYS.500
	SYS : YTM Tracking (HP 83651A)	SYS.600
	SYS : YTM Tracking (HP 83621A/31A)	SYS.650
	SYS : YTM Biasing	SYS.700

SYS.102 Perform the following setup:

1. Set the line power switch to standby.
2. Disconnect W14 from the YO (A26J2). Ensure that the cable does not short out anything else.
3. Set the line power switch to ON.
4. Press **PRESET** **START** **3** **GHz** **STOP** **7** **GHz**.
5. Press **SWEEP TIME** **15** **msec**. (Ignore the UNLOCK message.)
6. Set the oscilloscope as follows:
 - Trigger on negative edge.
 - Sweep time 10 msec.
7. Compare the waveform on the oscilloscope to the one shown. Ignore the amplitude of the pulses. Look for A5 sweeping to lock.
8. Reconnect W14 to A26J2.

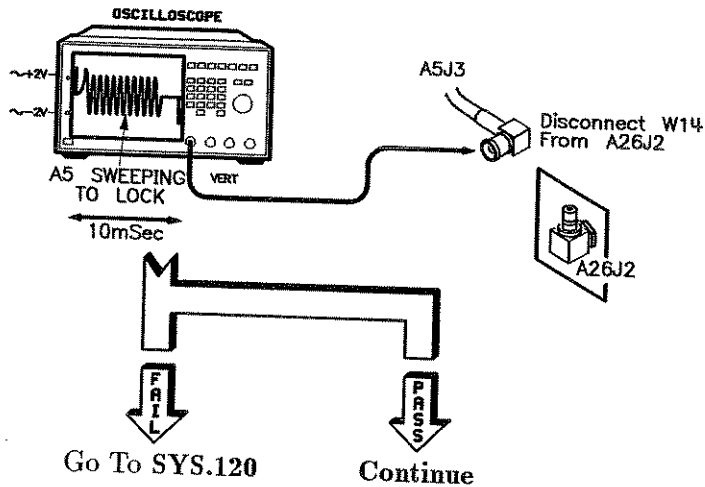

SYS.104 Perform the following setup:

1. Press **PRESET** **SERVICE**.
2. Select **Selftest Menu**.
3. Press **282** **ENTER**.
4. Select **Log** (asterisk on).

5. Select **Output Menu** **When to Log Always** (asterisk on).
6. Press **(PRIOR)**.
7. Select **Do Test #282**.
8. Note the data points that fail and select **CONT** until the test is complete.

The "YO Driver Gain and Linearity" adjustment is the most-likely cause of failure of the previous test. Other YO-related adjustments can also be contributing to the failures.

If the adjustments don't resolve the failure, or if you have good reason to suspect another assembly rather than the adjustments, use the following table. The table, used with the pass/fail data obtained from the previous test, indicates which assembly is the most-likely cause of failure. Each paragraph indicates several possible causes of failure in order of most probable cause listed first.

Data Point Failures	Go To Paragraph
2.303 GHz only	SYS.105
5.7499 GHz only	SYS.106
6.8009 GHz only	SYS.106
7.4 GHz only	SYS.107
Switching Test only	SYS.108
2.303 GHz and 6.8009 GHz only	SYS.109
All Other Combinations	SYS.110

- SYS.105**
1. YO adjustments.
 2. Sampler adjustments.
 3. Sampler (A6).
 4. YO (A26).

- SYS.106**
1. Sampler adjustments.
 2. Sampler (A6).
 3. YO (A26).
- SYS.107**
1. YO adjustments.
 2. RF path from the mod/splitter (A25) to the sampler (A6). This path includes FL2, W51, W54 path and A35 (not present in some instruments).
 3. YO (A26).
 4. YO driver (A13).
- SYS.108**
1. YO phase detector (A5).
 2. YO driver (A13).
 3. YO (A26).
- SYS.109**
1. Sampler (A6).
 2. Sampler adjustments.
- SYS.110**
- Using the troubleshooting block diagram located at the end of "Special Cases", examine the YO loop for the cause of failure:
1. RF path from the directional coupler (A39) to the sampler (A6).
 2. YO, sampler, and YO phase detector adjustments.
 3. Sampler, YO (A26), or mod/splitter.
 4. YO phase detector (A5) or YO driver (A13).
- SYS.120**
- Replace W14. Then go to the Troubleshooting Foldout, block 1 (located just prior to the "Special Cases" tab).

SYS.101 Perform the following:

1. Set the line power switch to standby.
2. Disconnect W14 from A5J3.
3. Set the line power switch to ON.
4. Press **PRESET** **START** **3** **GHz** **STOP** **7** **GHz**.
5. Press **SWEEP TIME** **15** **msec**. (Ignore the UNLOCK message.)
6. Set the oscilloscope as follows:
 - Trigger on negative edge.
 - Sweep time 15 msec.
7. Compare the waveform on the oscilloscope to the one shown. Ignore the amplitude of the pulses. Look for A5 sweeping to lock.
8. Reconnect W14 to A5J3.

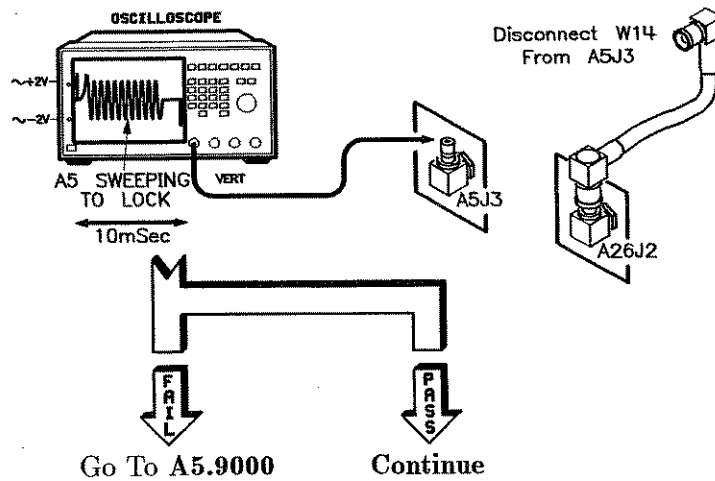

SYS.102 Perform the following setup:

1. Set the line power switch to standby.
2. Disconnect W14 from the YO (A26J2). Ensure that the cable does not short out anything else.
3. Set the line power switch to ON.
4. Press **PRESET** **START** **3** **GHz** **STOP** **7** **GHz**.
5. Press **SWEEP TIME** **15** **msec**. (Ignore the UNLOCK message.)
6. Set the oscilloscope as follows:
 - Trigger on negative edge.
 - Sweep time 10 msec.
7. Compare the waveform on the oscilloscope to the one shown. Ignore the amplitude of the pulses. Look for A5 sweeping to lock.
8. Reconnect W14 to A26J2.

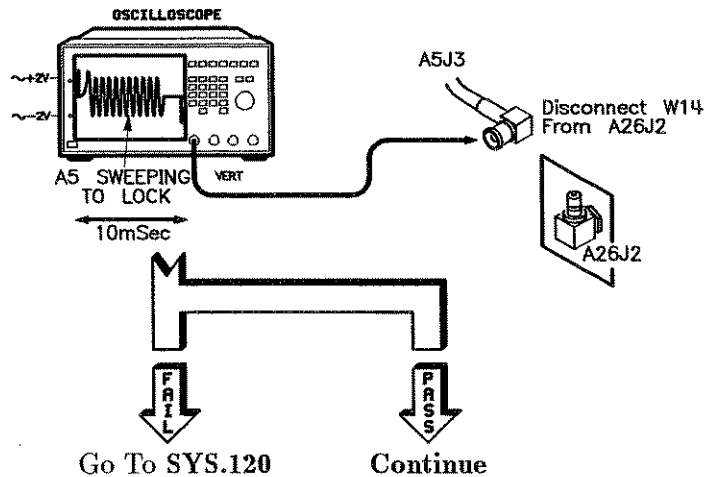

SYS.104 Perform the following setup:

1. Press **PRESET** **SERVICE**.
2. Select **Selftest Menu**.
3. Press **282** **ENTER**.
4. Select **Log** (asterisk on).

5. Select **Output Menu** **When to Log Always** (asterisk on).
6. Press **PRIOR**.
7. Select **Do Test #282**.
8. Note the data points that fail and select **CONT** until the test is complete.

The “YO Driver Gain and Linearity” adjustment is the most-likely cause of failure of the previous test. Other YO-related adjustments can also be contributing to the failures.

If the adjustments don’t resolve the failure, or if you have good reason to suspect another assembly rather than the adjustments, use the following table. The table, used with the pass/fail data obtained from the previous test, indicates which assembly is the most-likely cause of failure. Each paragraph indicates several possible causes of failure in order of most probable cause listed first.

Data Point Failures	Go To Paragraph
2.303 GHz only	SYS.105
5.7499 GHz only	SYS.106
6.8009 GHz only	SYS.106
7.4 GHz only	SYS.107
Switching Test only	SYS.108
2.303 GHz and 6.8009 GHz only	SYS.109
All Other Combinations	SYS.110

- SYS.105**
1. YO adjustments.
 2. Sampler adjustments.
 3. Sampler (A6).
 4. YO (A26).

- SYS.106**
1. Sampler adjustments.
 2. Sampler (A6).
 3. YO (A26).
- SYS.107**
1. YO adjustments.
 2. RF path from the mod/splitter (A25) to the sampler (A6). This path includes FL2, W51, W54 path and A35 (not present in some instruments).
 3. YO (A26).
 4. YO driver (A13).
- SYS.108**
1. YO phase detector (A5).
 2. YO driver (A13).
 3. YO (A26).
- SYS.109**
1. Sampler (A6).
 2. Sampler adjustments.
- SYS.110**
- Using the troubleshooting block diagram located at the end of "Special Cases", examine the YO loop for the cause of failure:
1. RF path from the directional coupler (A39) to the sampler (A6).
 2. YO, sampler, and YO phase detector adjustments.
 3. Sampler, YO (A26), or mod/splitter.
 4. YO phase detector (A5) or YO driver (A13).
- SYS.120**
- Replace W14. Then go to the Troubleshooting Foldout, block 1 (located just prior to the "Special Cases" tab).

SYS.200

1. Check W33 (A22J4 to A24J6) for poor connection or damage.
2. Reseat the pulse assembly (A9).
3. Replace the pulse assembly (A9) or the low band microcircuit (A24).

SYS.300

1. Check all cabling and connections associated with the ALC (A10) and low band (A24) assemblies.
2. Perform the low band (A24) and ALC (A10) adjustments.

SYS.500

1. Check all cabling and connections associated with the ALC (A10) and the AM modulator (A38).
2. Perform the ALC adjustments.
3. Replace the AM modulator if it has not already been replaced.
4. Replace the RF interface (A20).
5. Replace the ALC assembly (A10).

SYS.600

For the HP 83651A only, perform the following setup:

1. Set the power switch to standby.
2. Reconnect any disconnected cables.
3. Disconnect W60 from the amplifier/filter (A29) as shown in the following figure.
4. Set the line power switch to ON.
5. Press **PRESET** **CW** **ALC**.
6. Select **Leveling Mode ALCoff**.
7. Press **CW**.
8. Press **2** **GHz**.

The following sequence exercises direct control over the power level with the ALC loop open. Continue with the following sequence:

1. Press **POWER LEVEL**.
2. Use the rotary knob to set the ALC for maximum measured power.
3. Using the rotary knob, the *measured* RF power should be adjustable from ≤ -28 to ≥ 0 dBm.
4. Press **CW**.
5. Press **▲** (increments frequency).

Repeat steps 1 through 5 until the CW frequency equals 26.5 GHz.

If there is an unlevelled condition at a specific frequency, set that CW frequency and repeat steps 1 through 3.

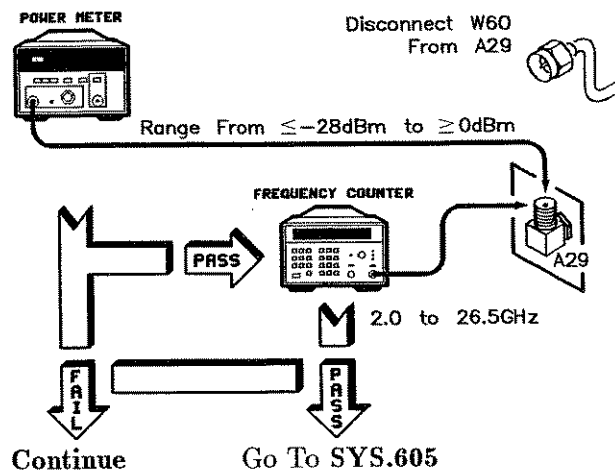

SYS.601 Perform the following setup:

1. Set the power switch to standby.
2. Reconnect any disconnected cables.
3. Remove W57 which connects the AM modulator (A38) to the amplifier/filter (A29).
4. Turn power on.
5. Press **PRESET** **CW** **ALC**.
6. Select **Leveling Mode ALCoFF**.
7. Press **CW**.
8. Press **2** **GHz**.

The following sequence exercises direct control over the power level with the ALC loop open. Continue with the following sequence:

1. Press **POWER LEVEL**.
2. Use the rotary knob to set the ALC for maximum measured power.
3. Using the rotary knob, the *measured* RF power should be adjustable from ≤ -28 to ≥ 0 dBm.
4. Press **CW**.
5. Press **▲** (increments frequency).

Repeat steps 1 through 5 until the CW frequency equals 26.5 GHz.

If there is an unlevel condition at a specific frequency, set that CW frequency and repeat steps 1 through 3.

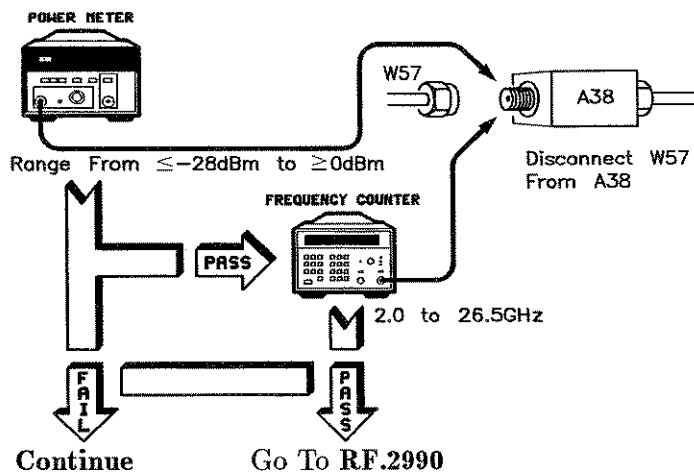

SYS.602 Perform the following setup:

1. Set the power switch to standby.
2. Reconnect any disconnected cables.
3. Disconnect W56 from the A28 amp/multiplier.
4. Connect a power meter to the output of A28.
5. Turn power on.
6. Press **CW**.
7. Press the up arrow and increment the frequency from 2 to 26.5 GHz. The power level should be greater than +5 dBm. Use a frequency counter to verify that the end points of the frequency range have been measured.

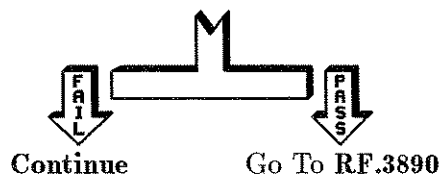

SYS.603 Perform the following setup:

1. Set the power switch to standby
2. Reconnect any disconnected cables.
3. Disconnect W49 from the A41 diode switch.
4. Connect a power meter to the output of A41.
5. Turn power on.
6. Press **CW**.
7. Press the up arrow and increment the frequency from 2 to 7 GHz. The power level should be greater than +8 dBm. Use a frequency counter to verify that the end points of the frequency range have been measured.

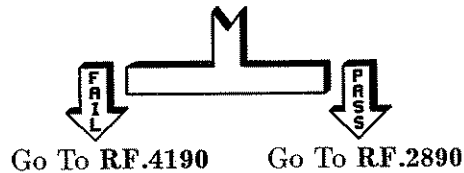

SYS.605 Use a power meter to measure the power out the RF output connector.

Does power meet specifications in all bands?

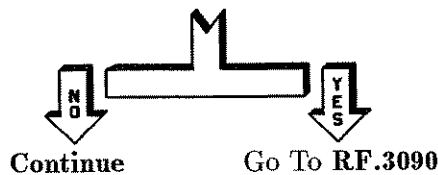

SYS.606 Perform the following setup:

1. Set the power switch to standby.
2. Reconnect any disconnected cables.
3. Remove the hard line which connects to the input of the bridge detector.
4. Turn power on.
5. Press **PRESET** **CW** **ALC**.
6. Select Leveling Mode ALCoff.

7. Press **CW**.
8. Press **2** **GHz**.

The following sequence exercises direct control over the power level with the ALC loop open. Continue with the following sequence:

1. Press **POWER LEVEL**.
2. Use the rotary knob to set the ALC over its full range (approximately -80 dBm to 0 dBm).
3. Using the rotary knob, the *measured* RF power should be adjustable from ≤ -8 to ≥ 0 dBm.
4. Press **CW**.
5. Press **▲** (increments frequency).

Repeat steps 1 through 5 until the CW frequency equals 50 GHz.

If there is an unlevelled condition at a specific frequency, set that CW frequency and repeat steps 1 through 3.

Range From ≤ -8 dBm to $\geq +7$ dBm
(HP 83651A)

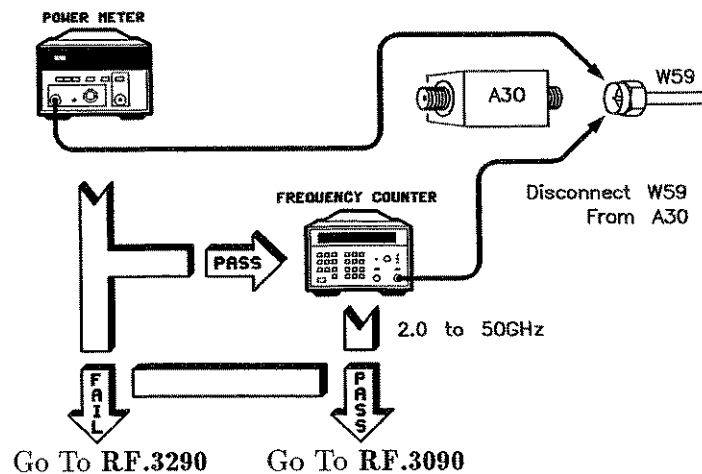

SYS.650

For the HP 83621A/31A only, perform the following setup:

1. Set the power switch to standby.
2. Reconnect any disconnected cables.
3. Disconnect W45 from the amp/multiplier (A28) as shown in the following figure.
4. Set the line power switch to ON.
5. Press **PRESET** **CW** **ALC**.
6. Select **Leveling Mode ALCOff**.
7. Press **CW**.
8. Press **2** **GHz**.

The following sequence exercises direct control over the power level with the ALC loop open. Continue with the following sequence.

1. Press **POWER LEVEL**.
2. Use the rotary knob to set the ALC for maximum measured power.
3. Using the rotary knob, the *measured* RF power should be adjustable from ≤ -17 to ≥ 13 dBm from 2 to 20 GHz and from < -17 to ≥ 7 dBm from 20 to 26.5 GHz.
4. Press **CW**.
5. Press the up arrow (increments frequency).

Repeat steps 1 through 5 until the CW frequency equals 26.5 GHz (HP 83631A) or 20 GHz (HP 83621A).

If there is an unlevelled condition at a specific frequency, set that CW frequency and repeat steps 1 through 3.

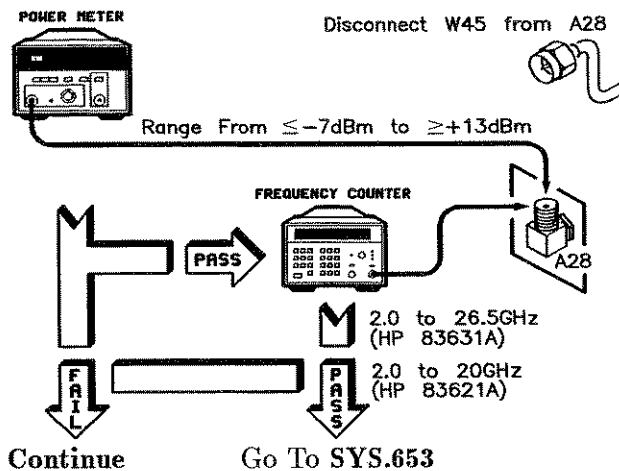

SYS.651 Perform the following setup:

1. Set the power switch to standby.
2. Reconnect any disconnected cables.
3. Remove W57 which connects the AM modulator (A38) to the amp/multiplier (A28).
4. Turn power on.
5. Press **PRESET** **CW** **ALC**.
6. Select **Leveling Mode ALCOff**.
7. Press **CW**.
8. Press **2** **GHz**.

The following sequence exercises direct control over the power level with the ALC loop open. Continue with the following sequence:

1. Press **POWER LEVEL**.
2. Use the rotary knob to set the ALC for maximum measured power.
3. Using the rotary knob, the *measured* RF power should be adjustable from ≤ -28 to ≥ 11 dBm from 2 to 7 GHz.
4. Press **CW**.
5. Press the up arrow (increments frequency).

Repeat steps 1 through 5 until the CW frequency equals 26.5 GHz (HP 83631A) or 20 GHz (HP 83621A).

If there is an unlevel condition at a specific frequency, set that CW frequency and repeat steps 1 through 3.

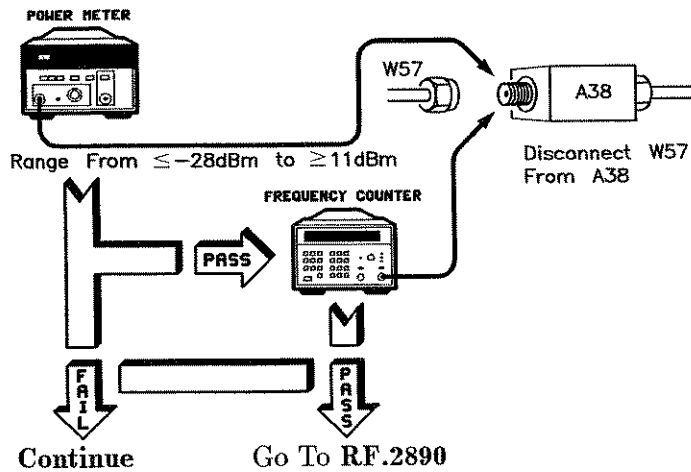

SYS.652 Perform the following setup:

1. Set the power switch to standby.
2. Reconnect any disconnected cables.
3. Disconnect W49 from the A41 diode switch.
4. Connect a power meter to the output of A41.
5. Turn power on.
6. Press **CW**.
7. Press the up arrow and increment the frequency from 2 to 7 GHz. The power level should be $\geq +8$ dBm. Use a frequency counter to verify that the end points of the frequency range have been measured.

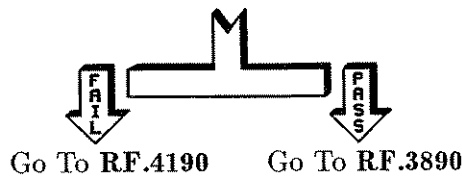

SYS.653 Use a power meter to measure the power out the RF output connector.

Does power meet specifications in all bands?

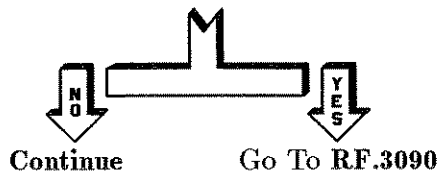

SYS.654 Perform the following setup:

1. Set the power switch to standby.
2. Reconnect any disconnected cables.
3. Remove W45 which connects to the input of the bridge detector.
4. Turn power on.
5. Press **PRESET** **CW** **ALC**.
6. Select **Leveling Mode ALCoff**.
7. Press **CW**.
8. Press **2** **GHz**.

The following sequence exercises direct control over the power level with the ALC loop open. Continue with the following sequence:

1. Press **POWER LEVEL**.
2. Use the rotary knob to set the ALC over its full range (approximately -80 dBm to 0 dBm).
3. Using the rotary knob, the *measured* RF power should be adjustable from ≤ -8 to ≥ 13 dBm.
4. Press **CW**.
5. Press **▲** (increments frequency).

Repeat steps 1 through 5 until the CW frequency equals 26.5 GHz (HP 83631A) or 20 GHz (HP 83621A).

If there is an unlevelled condition at a specific frequency, set that CW frequency and repeat steps 1 through 3.

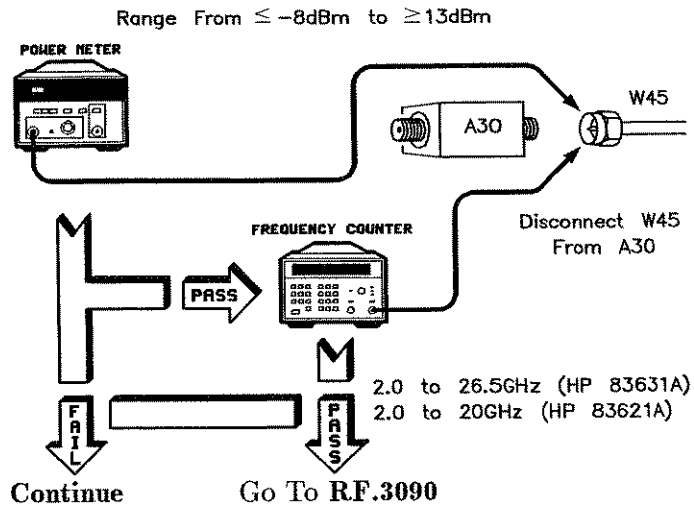

SYS.655 Replace W45 and go to the Troubleshooting Foldout, block 1 (located just prior to the "Special Cases" tab).

SYS.700

1. Check the cabling associated with the amplifier/multiplier(A28).
2. Replace the amplifier/multiplier (go to RF.2890).

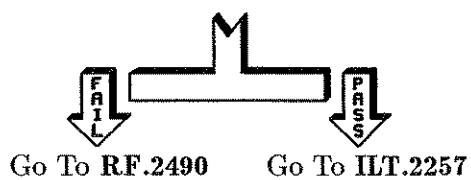

1. After Replacement or Repair

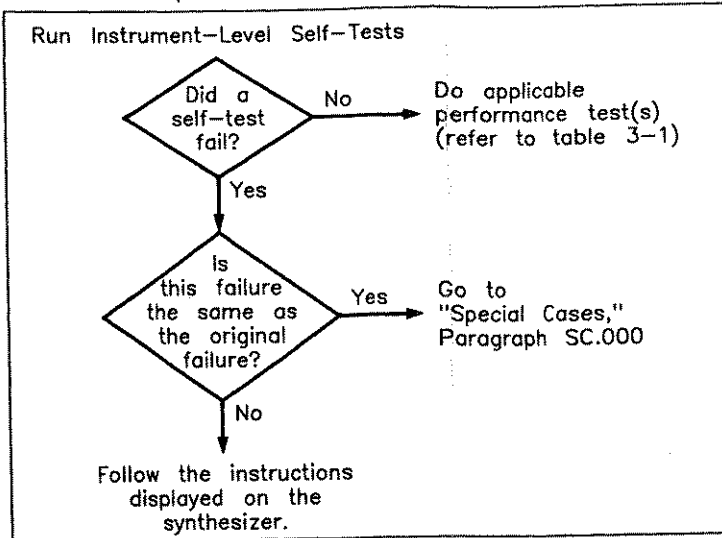

2. After Adjustment Only

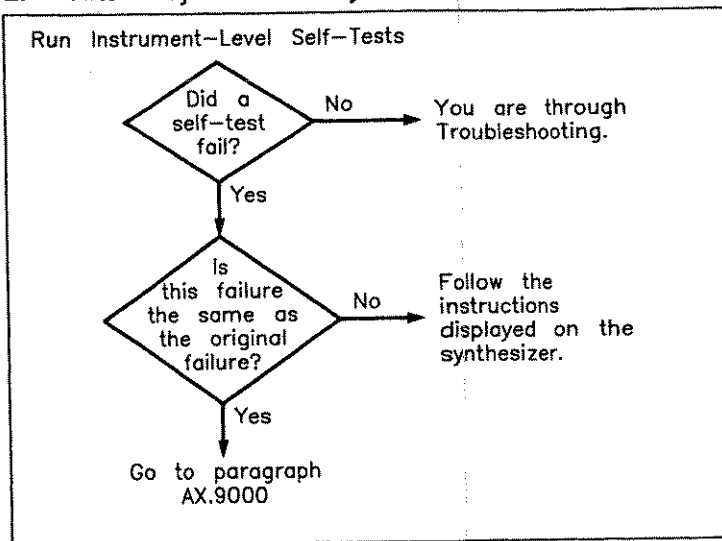

TROUBLESHOOTING
FOLDOUT



Special Cases

SC.000

Introduction

If you have not used the “Instrument Level Troubleshooting” section yet, go to ILT.000 before continuing with “Special Cases”. The “Instrument Level Troubleshooting” section contains help with hard failures, performance test and adjustment failures, as well as some system failures.

“Special Cases” is not a step-by-step process. It is a collection of routines, techniques, and information describing the block diagram. It deals with failures and situations not covered in the previous troubleshooting sections. This information is intended to be used with the overall block diagram at the end of this section. In using this section you will be required to select and develop your own testing processes and make your own judgments in analyzing the results of your tests.

SC.100 Safety Considerations

Warning



When the instrument is connected to ac line power or the A18 high voltage neon indicator is on, there are voltages present that can cause personal injury or death. Only trained, qualified personnel, who are aware of the hazards involved, should perform service on this instrument with its protective covers removed. An isolation transformer must be used during all power supply troubleshooting procedures.

Observe all safety practices. Remove all jewelry/metal that can short to ground.

Line power is located at the rear of the instrument under the red plastic protective cover. However, dangerous voltages exist outside this area especially in the covered power supply section and the cable harnesses located at the rear of the instrument. Before removing the power supply cover, servicing any of the cables or harnesses, or working in the proximity of these parts, completely disconnect line power and wait for all power supply indicators to go off. Follow this procedure anytime you install or remove assemblies or parts or otherwise physically service the instrument.

If your instrument does not have a red, plastic WARNING cover at the bottom rear of the motherboard, install one before continuing. Completely disconnect line power before doing any servicing with the warning cover removed or damaged. Also, completely disconnect line power before installing or removing the warning cover.

SC.200

Classify Your Failure

Classify your failure using the following definitions:

Failure	Definition
System	The failure has only been demonstrated as a part of a system (a collection of instruments). In general, the failure cannot be repeated or characterized without a system present.
Repeatable	The failure occurs each and every time a particular circumstance or sequence of events occurs. (The opposite of repeatable is intermittent.)
Detected	The failure is reported by the firmware diagnostics. If a failure is reported after running the full self-tests, then the failure is <i>detected</i> regardless of whether or not the failure has been <i>isolated</i> . (Don't use "Special Cases" unless "Instrument Level Troubleshooting" did not isolate the failure.)

After you have classified your failure, use this table to determine which techniques to use to isolate your failure.

FAILURE			PARAGRAPHS
System	Repeatable	Detected	
No	No	No	SC.210 SC.250 SC.230 SC.220
No	No	Yes	SC.210 SC.250 SC.230
No	Yes	No	SC.220 SC.230 SC.250
No	Yes	Yes	SC.220 SC.250 SC.230
Yes	Yes or No	Yes or No	SC.240

As an example, if an instrument has an intermittent loss of RF power out the front panel (maybe it fails once a day) that hasn't been detected by the diagnostics, you would use the techniques explained in paragraphs SC.210, SC.250, SC.230 and SC.220. This is because it is a nonsystem failure, nonrepeatable (intermittent) failure, and undetected by the diagnostics.

SC.210

Looping and Logging

The service looping and logging techniques can be used to localize an intermittent failure. Looping repeatedly cycles the instrument through a series of states or tests. Logging reports any detected failures. These techniques work well with temperature cycling. Other techniques that may be useful are frequency list mode and alternate registers. The list mode and alternate registers lack a logging feature but they can be used to exercise the instrument in a customized fashion without the use of an external controller or computer.

How to Loop and Log a Diagnostic Test

You may loop on the full self-tests (test #0), a group of tests (for example test #47 tests the A5 assembly), or on a single test. The following example loops on a single diagnostic test:

1. Press **PRESET** **SERVICE**.
2. Select **Selftest Menu**.
3. Press **51** **ENTER**. This is the "IF Frequency Counter" test.
4. Select **Loop** (asterisk on).
5. Select **Do Test #51**.

The instrument will continuously repeat test #51. Each time the test is completed the Number of PASSES or Number of FAILS is updated on the display. The selftest menu will be updated with the results of the last test. (This can be useful in determining how often a failure occurs.)

Continue with the following:

6. Select **Loop** (asterisk off). The looping should stop.
7. Select **Do Test #51**.

Notice that the test is run once and the pass/fail status in the selftest menu is updated. Continue with the following to log the results of test #51 to the display.

8. Select **Output Menu** **When to Log Always** (asterisk on).
9. Press **PRIOR**.
10. Select **Log** (asterisk on).

6 Special Cases

11. Select **Do test #51**.
12. Select **Cont** until the test is complete (the selftest menu will return when the test is complete).

Selecting **When to Log Always** causes the results of each measurement or group of measurements to be reported. In many cases, this might be too much data. To reduce the amount of data, and how often you have to select **Cont**, you can select **When to Log OnFail**. In this case, only failures are logged to the display. To continually run test #51 and report only failures to the display, loop and log to the display as shown in the following sequence:

13. Select **Output Menu** **When to Log OnFail** (asterisk on).
14. Press **(PRIOR)**.
15. Select **Loop** (asterisk on). **Log** also has an asterisk on.
16. Select **Do test #51**.
17. To stop the looping, select **Loop** (asterisk off).
18. To restart the looping, select **Loop** (asterisk on) and **Do Test #51**.
19. Remove the instrument top cover and carefully remove the coax cable from A5J1 (the left-most coax cable connected to A5). Notice that the instrument immediately begins to log the failures to the display.
20. Reconnect the cable and press **Cont** (you may have to press **Cont** more than once). When the test is complete, the instrument will begin logging to the display until it encounters another failure.
21. To stop looping and logging, again press **Loop** and **Log** (asterisks off).

In the following example, you will run a test and log all of the test results to a printer. As in logging to the display, you can choose to log all of the data or fail-only data. Logging data to a printer can be useful in situations that require testing over a long period of time or during temperature cycling.

22. Connect the printer to the synthesizer's HP-IB port.
23. Set the printer to listen only and address 0.
24. Cycle the printer power.
25. Select **Output Menu** **Log Data to Printer** (asterisk on).
26. Select **When to Log Always** (asterisk on).
27. Press **(PRIOR)**.

28. Press **Loop** (asterisk off). **Log** also has an asterisk on.
29. Select **Do Test #51**.

The printer should print the results of test #51. To stop the printing, select **Loop** (asterisk off).

The following demonstrates logging only failures to the printer.

30. Select **Output Menu**.
31. Select **When to Log OnFail** (asterisk on). **Log Data to Printer** also has an asterisk on.
32. Press **PRIOR**.
33. Select **Loop** (asterisk on). **Log** also has an asterisk on.
34. Select **Do Test #51**.

The printer will not print unless the synthesizer fails this test.

35. Remove the instrument top cover and carefully remove the coax cable from A5J1 (the left-most coax cable connected to A5). Notice that the printer immediately begins to log the failures.
36. Reconnect the cable. The printer should stop logging.
37. To stop looping the test, select **Loop** (asterisk off).

Frequency List and Alternate Registers

These features may be used to replicate a problem. Frequency list allows you to set up an arbitrary list of frequencies, power levels, and dwell times. Alternate registers causes the synthesizer to alternate on successive sweeps between the present instrument state and a second instrument state stored in an internal register. See the "Operating and Programming Reference" for additional information. Once you have created a frequency list or have set up for alternating registers, then exercise the instrument and check for unlock failures.

The following example creates a frequency list that steps from 200 to 500 MHz in 10 steps. The instrument will dwell at each frequency for 500 ms. The list is saved to register 1. The instrument's fault and unlock indicators are monitored. Finally, a ramp sweep is alternated with a list sweep.

1. Press **PRESET** **FREQUENCY** **MENU**.

8 Special Cases

2. Select **List Menu**.
3. Select **Delete Menu All** (This clears any current list.)
4. Select **Auto Fill Start**.
5. Press **200 MHz**.
6. Select **Auto Fill Stop**.
7. Press **500 MHz**.
8. Select **Auto Fill #Pts**.
9. Press **10 ENTER**.
10. Select **Global Dwell**.
11. Press **500 msec**.
12. Press **SWEEP MENU**.
13. Select **Sweep Mode List** (asterisk on). (This starts the list sweep mode.)
14. Press **SAVE 1 ENTER** (Saves the list to register 1.)

Now, to view the instrument's state:

15. Press **SERVICE**.
16. Select **Fault Menu**.
17. Select any one of the three fault menus.
18. Press **PRIOR**.
19. Select **Unlock Info** (asterisk on). You can now see the state of any of the major loops (see SC.220 for more information)

The following is an example of a setup for alternating registers. One will be the frequency list saved to register 1 in the previous example, the other will be the preset state of the instrument (an analog sweep).

20. Press **PRESET SYSTEM MENU** (the instrument should be sweeping normally).
21. Select **Alternate Regs** (asterisk on).
22. You should now see the sweep indicator flashing as it switches between the two setups.

SC.220

Direct Control and Monitoring

Direct control and monitoring allow you to test or monitor hardware in a particular state. Since you have some control over the individual modules and loops, you can verify whether a specific instrument state causes a failure and you can check the apparent state (what the processor thinks) of the hardware.

The following example sets up the fractional-N (A4) loop at 50 MHz, looks at the fractional-N OOL line (Out Of Lock), and views the YO and other frequencies.

Note



When the display indicates a loop value, this is the frequency that the microprocessor has set up. The frequency was not measured and reported. Therefore, if the frequency displayed is different from real frequency you have an indication of a problem.

1. Press **PRESET** **CW** (CW keeps the fractional-N at one frequency).
2. Press **SERVICE**.
3. Select **Tools Menu**.
4. Select **Cnt1PLL Menu** (Control Phase Locked Loop).
5. Select **Frac N Menu** **CW**.
6. Press **50** **MHz** (Sets the fractional-N to 50 MHz).
7. Press **PRIOR** **PRIOR**.
8. Select **ViewHdwr Menu** (View Hardware).
9. Select **PLLs Freqs** (asterisk on). You can see the fractional-N is set to 50 MHz.

Interpret the **ViewHwr** display as follows:

Label	Interpretation
FRAC-N(MHz)	The frequency of the fractional-N (A4).
SAMPLER(MHz)	The frequency of the sampler (A6).
/	The fractional-N frequency divisor in the YO phase detector (A5). This number should be 3 or 4.
HARM	The harmonic of the sampler frequency.
BAND	The frequency band we are using (0 through 4). This indicates the harmonic of the YO to which the SYTM (A28) is tuned. [Except in the case of band 0 where the frequency of the YO is mixed down using the low band (A24) assembly.]

Now select **YO Freq/Harm** (asterisk on). Interpret the display as follows:

Label	Interpretation
CW(MHz)	The frequency of the YO.
BAND	The frequency band we are using (0 through 4). This indicates band 2 because the frequency is set to slightly more than 10 GHz.

Just as you set the fractional-N frequency, you can control the sampler (A6) frequency using **(SERVICE) Tools Menu CntlPLL Menu Sampler Menu**. In the sampler menu you can set the frequency of the sampler.

Other useful softkeys in the **CntlPLL Menu** are **Loop Cntl Menu** and **NoPhase Lock**. **Loop Cntl Menu** allows you to control the phase lock loop frequency. **NoPhase Lock** lets you open the YO loop which allows you to tune the YO independent of the rest of the loop.

1. Select **PLLs Freqs** (asterisk off).
2. Press **(SERVICE)**.
3. Select **Unlock Info** (asterisk on).

The modules shown are checked for unlock failures. If no unlock is found, OK is displayed.

Sometimes it is useful to open up the ALC loop to keep it from railing. (Press **ALC** and select **Leveling Mode ALCOff**.) An UNLVLED indicator comes on because leveling (ALC action) is not functioning. In normal operation this indicator means that the power requested is not available.

SC.230 Exchanging Assemblies

Exchanging assemblies might be the only way to isolate some problems. The following is a list of assemblies and the adjustments that may be required to make the synthesizer operational if the assembly is replaced. If the adjustments are not performed, failures may occur such as severe power loss or drop out, failure to lock or sweep properly, squegging, and unlevelled indications. Perform the adjustments indicated in the following table in order to verify that you have eliminated the problem assembly. Then, to ensure that the synthesizer meets specifications, go to "Post-Repair" in the *Service* manual and perform the required adjustments and performance tests.

Assembly	Adjustments Required for Operation	Difficulty	Equipment Required
A15	ADC	Low	Minimal
	Move Memory (A15.9001)	Medium	None
A5	YO Loop Gain	Low	None
A6	Sampler Assembly	Low	None
A9	Amplifier Detector Offset	Low	None
	Pulse Delay	Low	Minimal
A12	SYTM Adjustments	High	Extensive
	Low Power SRD Bias	Low	Minimal
A13	YO Driver +10V Reference	Low	None
	YO Gain & Linearity	Low	None
	YO Delay	Low	None
A28	SYTM Adjustments	High	Extensive
A33	Power Flatness	Low	Minimal
	Amplifier Detector Gain	Medium	None

Calibration data specific to your instrument is stored in the microprocessor (A15). If you are exchanging assemblies, be sure you know which ones are the originals. The original calibration data will *not* apply to new assemblies. To avoid having to reacquire calibration data through adjustments that can be lengthy, once you have located the failed assembly ensure that you return all of the other *original* assemblies to the instrument.

The calibration data for the instrument resides in RAM and EEROM on A15. If A15 has failed, this data must be transferred to the new A15 assembly. Be *certain* that A15 has failed before attempting to move the calibration data. An error in the procedure could cause all of this information to be lost and recreating the information is a very lengthy procedure. A15.9001 gives the procedure for transferring the calibration data.

On the HP 83651A, the detector CR1 (part of A30) and its bias board should be replaced as one unit. The bias board resistors are factory-selected. They are specifically selected to compensate for thermal drift. If the bias board or detector is replaced separately, the instrument is likely to exhibit RF power out drift.

SC.240

System Failures

System failures are failures that have only been demonstrated as a part of a system (a collection of instruments). In general, the failure cannot be repeated or characterized without a system present. When troubleshooting system failures, use the following suggestions in the order given:

1. Ensure that you have the proper equipment for troubleshooting. A spectrum analyzer and an oscilloscope are usually required.
2. Run the diagnostic routines of all instruments in the system. Eliminate any errors that are identified by the diagnostics before continuing.
3. Determine the minimum system required to replicate the problem. When eliminating portions of the system, eliminate software first, if possible.
4. Check the system for excessive cable lengths, poor grounds and improper installation (overheating, air blockage).
5. Verify that all instruments contain compatible versions of firmware and software.
6. If the failure is also intermittent, check the environment and timing of the failures. Note any relationship to time of day, local maintenance schedules,

day of the month, weekends, season, or local holidays. Also check any severe line power problems or limitations (these may be related to local production efforts.)

SC.250

Block Diagram Notes

This section describes the YO loop RF path and the two ALC loops and gives help interpreting the block diagram. Also, tables showing the interconnection of data, addresses, and busses are given.

The YO loop phase lock is obtained using a feedback path. The entire path (forward and feedback) is as follows. Beginning with the YO (A26), the signal is passed to the directional coupler. A sampled portion of the directional coupler output is fed back through W51, FL2, and W54 to the sampler (A6). Harmonic mixing takes place in the sampler (A6) and then the heterodyned output from the sampler (A6) is fed to the YO phase detector. This signal is mixed with the divided output of the fractional-N (A4) to obtain phase error information. This phase error signal is amplified by the YO driver and used to control the frequency of the YO (A26). Note that the YO is driven by a low frequency path (via A13) and a high frequency path out of the YO phase detector (A5). If either path is broken, the YO will not lock.

Two ALC loops exist. One loop exists for band 0 (not present in all instruments); the other loop is for all other bands. The band 0 path includes the sampled and detected output from the low band (A24) via W24 to the ALC (A10). This voltage is compared to a reference (from A14). The difference between these signals is an error signal that is amplified and sent back to the low band (A24) modulator.

The second ALC loop begins with the bridge detector. Like band 0, this signal goes to the ALC (A10) where it is compared to a reference. The difference between the reference and the detector output voltage is used as an error signal. This error signal is sent back to the AM modulator (A38) where it is used to control the loop gain. And finally the level-corrected signal out of the AM modulator (A38) is frequency multiplied, and filtered (A28) in the HP 83621A/31A and amplified and filtered (A29), and amplified and doubled (A32) in the HP 83651A.

Notice that the reference signal for level control in both ALC loops is created by the sweep generator (A14). This is specifically the “LEVEL REF TO A10” exiting the sweep generator. While it is not shown on the block diagram, it does connect directly to the ALC (A10). If this level reference is lost, the ALC loop will not be controllable.

The block diagram is intended to relate both physical and electrical information. The following items will help you interpret the block diagram:

- PC assemblies shown with tabs are located in the open card cage or in the the covered power supply cage (A17, A18) located at the left, rear corner of the instrument.
- The 22V transformer shown next to the switching regulator (A18) is located between the covered power supply section and the rear panel. Dangerous voltages exist in this area.
- All components located on the RF deck are located inside the heavy border labeled RF DECK.
- Semi-rigid coax cables are shown with a double line and are labeled with a reference designator (for example, W50 from A25 to A24 on the RF deck).
- Flexible coax cables are shown with a single line and are labeled with a reference designator (for example, W20 from A7J7 to A24).
- All other lines are part of the motherboard.
- All fuses are shown.
 - The rear panel line fuse is next to the switching regulator (A18).
 - Eight fuses are located on the post regulator (A16). Some of these fuses are soldered-in.
 - One fuse is located on the rectifier/filter (A17).
 - One fuse is located on the switching regulator (A18). This fuse has an LED located close by. If the LED is on, the fuse is good.
 - One fuse is located on the RF Interface (A20, on the RF deck).
- Options may be shown in the upper right-hand corner of the block diagram. The letters at the coax cables indicate how the options fit into the RF deck.
- Assemblies shown in the front or rear panels are located in those panels including A2. However, part of A2 is shown in the lower left-hand corner of the block diagram. This portion of A2 contains the front panel power switch and was positioned at this point on the block diagram for convenience.
- Signals are labeled with power and frequency limits if appropriate. Signals not labeled are either TTL (digital) signals or they are too complex or unique to characterize for the purposes of the block diagram.

- Cables are labeled with reference designators.
- Signals going from the RF interface (A20) to the RF deck are actually ribbon cables. These ribbon cables carry power supply voltages and signals required for controlling the microcircuits.

Instrument History

Introduction

This manual documents the current production versions of the HP 83621A/31A/51A instruments. As future versions of these instrument models are developed, this manual will be modified to apply to those instruments. Information provided in this chapter will then allow you to adapt this manual to the earlier versions.

All HP 83621A/31A synthesized sweepers with serial prefix numbers *lower* than 3103A are documented in a previous manual set. Order either 83621-90007 or 83631-90007.

Serial Prefix Numbers

This manual applies to synthesized sweepers with a model number and serial number prefix listed on the title page (see the serial number attached to the synthesizer's rear panel). Figure 2-1 shows a typical serial number label. A prefix (four digits followed by a letter), and a sequential suffix (five digits unique to each instrument), compose the serial number.

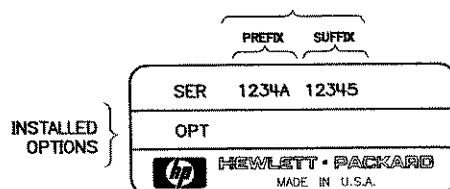

Figure 2-1. Typical Serial Number Label

How to Use Instrument History

Find the serial prefix number of your instrument in the following tables. make the changes that are listed for that prefix. The actual changes, with instructions, are on the following pages.

Note: Incorporate the changes in reverse alphabetical order.

HP 83621A/31A Instrument History Changes

Serial Prefix Number	Change	PCO (HP Internal Use Only)
3317A	No Change Needed	10940
3245A	B	10795, 10825
3213A	B	10258
3143A	B	10492
3139A	B	10385
3137A	B, A	10135
3108A	B, A	09966
3104A	B, A	10304
3103A	B, A	

HP 83651A Instrument History Changes

Serial Prefix Number	Change	PCO (HP Internal Use Only)
3317A	No Change Needed	10940
3245A	B	10795, 10825
3213A	B	10258
3143A	B	10492
3139A	B	10385
3044A	B	

Change B

Instruments with serial prefix 3245A and lower use a modulator/splitter (A25) rather than an AM modulator (A38), diode switch (A41), coupler (A39), and 20 dB attenuator (AT3). Also, HP 83651A instruments with serial prefix 3245A and lower use a DC blocking capacitor (A36) and a coupler/detector rather than the bridge detector (A30). Make the following changes to the “Troubleshooting” manual:

Instrument-Level Troubleshooting Section

ILT.2011

1. Change step 3 to read “Remove W51 which connects the mod/splitter (A25) to the filter (FL2).”
2. In step 8, verify that the power is ≥ -24.5 dBm.
3. Change the measurement setup illustration to show W51 being disconnected from the 20 dB attenuator (AT3) and a power measurement of ≥ -24.5 dBm.

ILT.2012

In step 3, change the directional coupler to the mod/splitter (A25).

ILT.2020

1. Change the directional coupler to the mod/splitter (A25).
2. Change the 20 dB attenuator to the filter (FL2).
3. Delete all references to the attenuator.

ILT.2112

1. Change A38 to A25.
2. Change RF.3890 to RF.2590.

ILT.2120

1. Change A38 to A25.
2. Change RF.3890 to RF.2590.

ILT.2130

Change AM modulator (RF.3890) to mod/splitter (RF.2590).

ILT.2255

Change step 3 to read:

“The bridge detector in the HP 83621A/31A or the coupler/detector in the HP 83651A (RF.3090).”

ILT.2256

1. In the second sentence, change “bridge detector” to “coupler/detector”.

2. Change step 5 to read:

“The bridge detector in the HP 83621A/31A or the coupler/detector in the HP 83651A (RF.3090).”

ILT.2257

1. Change step 2 to read:

“The amplifier/multiplier (RF.2890).”

2. Change step 5 to read:

“The bridge detector in the HP 83621A/31A or the coupler/detector in the HP 83651A (RF.3090).”

ILT.2620

In the table, change RF.3890 “(AM modulator)” to “RF.2590 (mod/splitter)”.

ILT.2650

1. Delete all references to A38.

2. In the table, change “AM modulator (A38)” to “mod/splitter (A25)”.

A6 Troubleshooting Section

A6.400

1. For the power measurement:
 - a. In step 7, set the synthesizer to 2.3 GHz.
 - b. In step 8, sweep from 2.3 to 7.4 GHz.
 - c. In step 8, verify that the power is greater than -22 dBm.
2. For the frequency measurement:
 - a. In step 1, set the synthesizer to 2.3 GHz.
 - b. In step 3, the frequency range is 2.3 to 7.4 GHz.
 - c. Change the measurement setup illustration to show these differences.

A6.401

1. For the power measurement:
 - a. Replace step 3 with the following text:
"Remove W51 [connects the mod/splitter (A25) to FL2]."
 - b. In step 7, set the synthesizer to 2.3 GHz.
 - c. In step 8, sweep from 2.3 to 7.4 GHz.
 - d. In step 9, verify that the power is greater than -22 dBm.
2. For the frequency measurement:
 - a. In step 1, set the synthesizer to 2.3 GHz.
 - b. In step 3, the frequency range is 2.3 to 7.4 GHz.
 - c. Change the measurement setup illustration to show these differences.

A6.402

1. For the power measurement:

- a. In step 3, W52 connects the YIG oscillator (A26) to the mod/splitter (A25).
 - b. In step 7, set the synthesizer to 2.3 GHz.
 - c. In step 8, set the power to ≥ 8 dBm; the frequency range is 2.3 to 7.4 GHz.
2. For the frequency measurement:
- a. In step 1, set the synthesizer to 2.3 GHz.
 - b. In step 3, the frequency range is 2.3 to 7.4 GHz.
 - c. Change the measurement setup illustration to show these differences.

A6.403

If W52 is *not* defective, go to RF.2590

A6.420

Replace A6.420 with the following text:

“There is a high-loss path between the mod/splitter (A25) and the sampler (A6). This path includes two hardlines (W54 and W51), and a low pass filter (FL2). The most likely failure is a poor connection. Correct the faulty connection or replace the faulty part (W54, FL2, W51).”

To check for excessive loss in a cable, filter, or isolator, apply a known-good signal for the frequency bands in question to the component (see the block diagram at the end of “Special Cases”) and test the output. Over the frequency range of 2.0 to 8.0 GHz, the loss for a coaxial cable should be ≤ 2.0 dB; the loss for a filter or an isolator should be ≤ 4.0 dB. Replace the defective part and go to the Troubleshooting Foldout, block 1 (located just prior to the “Special Cases” tab).“”

A10 Troubleshooting Section

A10.702

Change the last paragraph to read as follows:

“If you do not find any problems, replace A10 (go to A10.9000) if it has not already been replaced. Otherwise, replace the mod/splitter A25 (go to Rf.2590).”

RF Troubleshooting Section

RF.000

Add the following message:

RF : MOD-SPLIT Prelevel Det RF.200

RF.200 (New - add after RF.100)

Check the ribbon cable that connects the mod/splitter (A25) to the RF interface board (A20). If it is loose, reseat the cable. Correct any other obvious faults.

Perform the following test:

1. Press **PRESET** **SERVICE**.
2. Select **Selftest Menu**.
3. Press **267** **ENTER**.
4. Select **Do Test #267**.

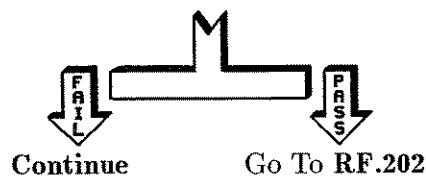

RF.201 (New - add after RF.202)

Set up for power measurement:

1. Set the line power switch to STANDBY.
2. Lift up the RF Deck into the service position (refer to the disassembly and replacement procedures).
3. Remove W52 (the cable that connects the YIG oscillator, A26, to the mod/splitter, A25.)
4. Set the line power switch to ON.
5. Press **PRESET** **CW** **SERVICE**.

6. Select **Tools Menu CntlPLL Menu NoPhaseLock** (asterisk on).
7. Select **LoopCntl Menu Y0 Loop Freq**
8. Press **2 GHz**
9. Using the rotary knob, sweep the frequency from 2 to 7 GHz.
10. Verify that power is ≥ 8 dbm across the 2 to 7 GHz frequency range.

Set up for frequency measurement:

1. Press **2 GHz**.
2. Increment the frequency using **▲**.
3. The measured frequency equals the front panel indication ± 40 MHz from 2 to 7 GHz.

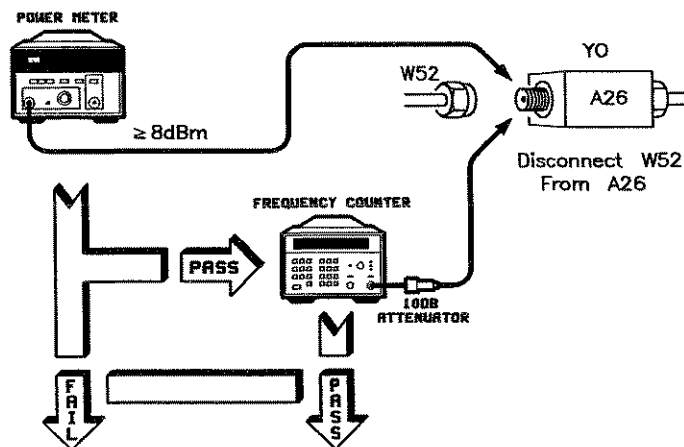

Go To **RF.2690** Go To **RF.2590**

RF.202 (New - add after RF.201)

The problem appears to be fixed. Go to the Troubleshooting Foldout, block 1 (located just prior to the "Special Cases" tab).

RF.801

1. In step 2, change A41 to A25.

2. In step 7, change 45 Mhz to 10 Mhz.
3. Use the RPG knob to vary the CW frequency over a range of 10 Mhz to 1.99 GHz.
4. The power should be > 7 dBm and the frequency should be 5.41 to 7.39 GHz.
5. Change the measurement setup illustration to show these differences.
6. If the measurement fails, go to RF.2590.

RF.802

1. In step 1, change A41 to A25.
2. In step 3, change 2 GHz to 1.9 GHz.

RF.2590 (New - add after RF.2491)

The mod/splitter (A25) is the most-likely failure. However, there is a small chance that the failure is A20 (the RF interface assembly) or W52 (the cable that connects A25, the modulator/splitter, to A26, the YO).

Has mod/splitter (A25) been replaced?

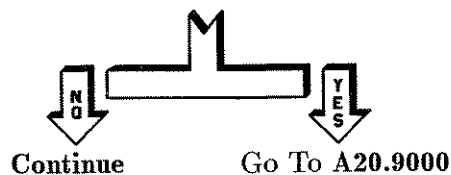

RF.2591 (New - add after RF.2590)

Following the disassembly and replacement procedures, replace the mod/splitter (A25). Then perform the appropriate adjustments and performance tests and restart troubleshooting.

RF.2990

Change the AM modulator to the amp/multiplier (A28).

RF.4190

Delete this paragraph.

**SYS Troubleshooting
Section**

SYS.000

1. Delete "(HP 83651A)" from the following message:
"SYS: YTM Tracking (HP 83651A) SYS.600."
2. Delete the following message:
"SYS: YTM Tracking (HP 83621A/31A) SYS.650."

SYS.110

In step 1, change "directional coupler (A39)" to "mod/splitter (A25)".

SYS.400 (New - add after SYS.300)

1. Check W32 (A20J3 to A25J3) for poor connection or damage.
2. Reseat the pulse board (A9).
3. Replace the pulse board (A9) or the mod/splitter microcircuit (A25).

SYS.500

1. In step 1, replace the A38 AM modulator with the A25 mod/splitter.
2. In step 2, perform the mod/splitter and the ALC adjustments.
3. In step 3, replace the AM modulator with the mod/splitter.

SYS.600 through SYS.655

Delete these sections.

SYS.600 (New - add after SYS.500)

Perform the following setup:

1. Set the power switch to standby.
2. Reconnect any disconnected cables.
3. Disconnect W45 or W56 from the amplifier/filter (A29) as shown in the following figure.
4. Set the line power switch to ON.
5. Press **PRESET** **CW** **ALC**.

6. Select **Leveling Mode ALCOff**.
7. Press **CW**.
8. Press **2** **GHz**.

The following sequence exercises direct control over the power level with the ALC loop open. Continue with the following sequence:

1. Press **POWER LEVEL**.
2. Use the rotary knob to set the ALC for maximum measured power.
3. Using the rotary knob, the *measured* RF power should be adjustable from ≤ -28 to ≥ 0 dBm.
4. Press **CW**.
5. Press **▲** (increments frequency).

Repeat steps 1 through 5 until the CW frequency equals 26.5 GHz (HP 83631A/51A) or 20 GHz (HP 83621A).

If there is an unlevelled condition at a specific frequency, set that CW frequency and repeat steps 1 through 3.

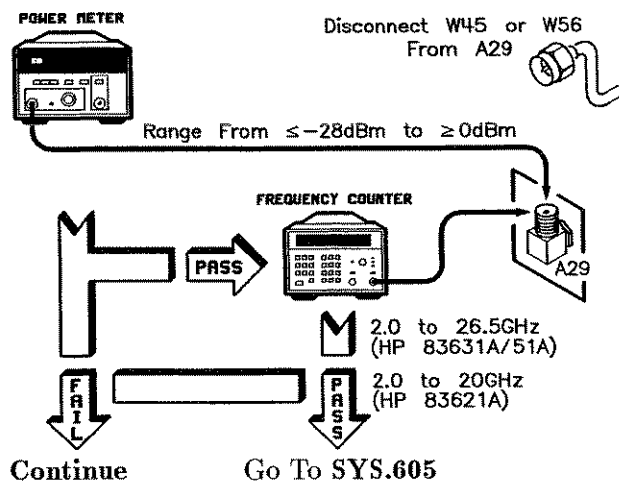

SYS.601 (New - add after SYS.600)

Perform the following setup:

1. Set the power switch to standby.
2. Reconnect any disconnected cables.

3. Remove W61 which connects the amplifier/multiplier (A28) to the amplifier/filter (A29).
4. Turn power on.
5. Press **PRESET** **CW** **ALC**.
6. Select **Leveling Mode ALCOff**.
7. Press **CW**.
8. Press **2** **GHz**.

The following sequence exercises direct control over the power level with the ALC loop open. Continue with the following sequence:

1. Press **POWER LEVEL**.
2. Use the rotary knob to set the ALC for maximum measured power.
3. Using the rotary knob, the *measured* RF power should be adjustable from ≤ -28 to ≥ 0 dBm.
4. Press **CW**.
5. Press **▲** (increments frequency).

Repeat steps 1 through 5 until the CW frequency equals 26.5 GHz (HP 83631A/51A) or 20 GHz (HP 83621A).

If there is an unlevelled condition at a specific frequency, set that CW frequency and repeat steps 1 through 3.

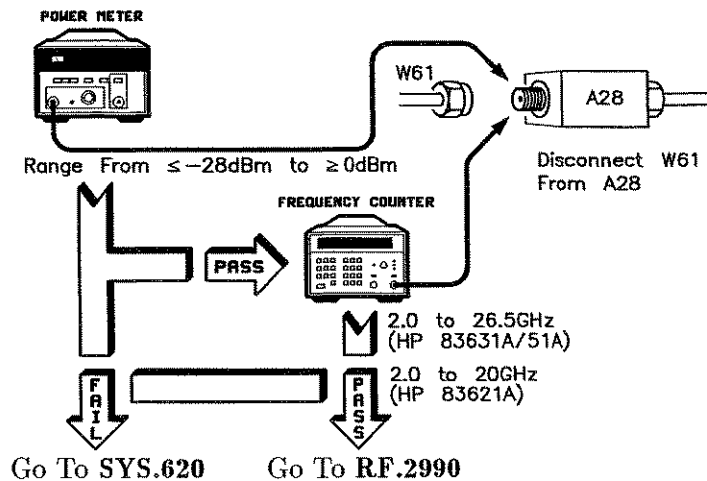

SYS.605 (New - add after SYS.601)

Use a power meter to measure the power out the front (or rear) panel RF output connector.

Does power meet specifications in all bands?

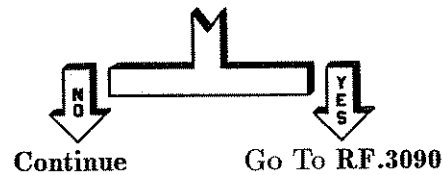

SYS.606 (New - add after SYS.605)

Perform the following setup:

1. Set the power switch to standby.
2. Reconnect any disconnected cables.
3. Remove the hard line which connects to the input of the bridge detector for HP 83621A/31A or coupler/detector for HP 83651A (A30).
4. Turn power on.
5. Press **PRESET** **CW** **ALC**.
6. Select **Leveling Mode ALCOff**.
7. Press **CW**.
8. Press **2** **GHz**.

The following sequence exercises direct control over the power level with the ALC loop open. Continue with the following sequence:

1. Press **POWER LEVEL**.
2. Use the rotary knob to set the ALC over its full range (approximately -80 dBm to 0 dBm).
3. Using the rotary knob, the *measured* RF power should be adjustable from ≤ -8 to ≥ 0 dBm (HP 83651A) or ≤ -8 to ≥ 10 dBm (HP 83621A/31A).
4. Press **CW**.
5. Press **▲** (increments frequency).

Repeat steps 1 through 5 until the CW frequency equals 50 GHz (HP 83651A), 26.5 GHz (HP 83631A), or 20 GHz (HP 83621A).

If there is an unlevelled condition at a specific frequency, set that CW frequency and repeat steps 1 through 3.

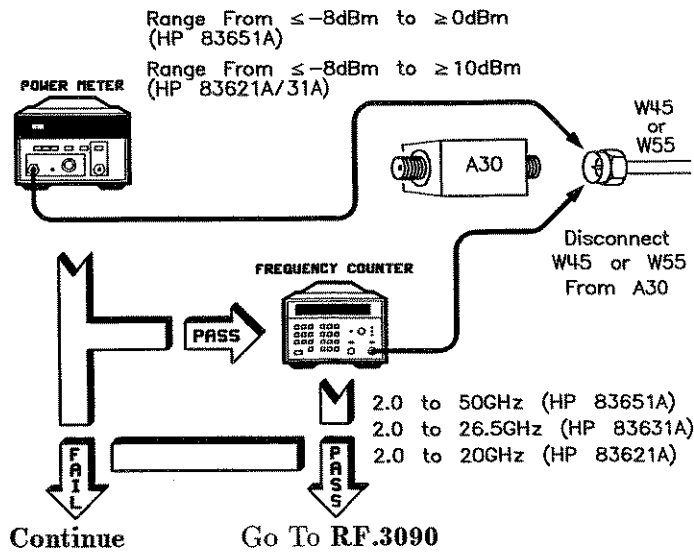

SYS.607 (New - add after SYS.606)

Select your instrument's model and go to the paragraph indicated.

Model	Go To Paragraph
83621A	SYS.610
83631A	SYS.610
83651A	RF.3290

SYS.610 (New - add after SYS.607)

Replace W45 and go to the Troubleshooting Foldout, block 1 (located just prior to the "Special Cases" tab).

SYS.620 (New - add after SYS.610)

Do the following:

1. Set the line power switch to standby.
2. Reconnect any disconnected cables.
3. Disconnect W49 from A25.
4. Turn the line power switch on.
5. Press **PRESET** **SERVICE**.
6. Select **Tools Menu** **ViewHdwr Menu** **Y0 Freq/Harm.**
7. Press **CW**.
8. Press **2** **GHz**.

Use the rotary knob to vary the CW frequency over a range of 2 GHz to 26.5 GHz. Measure the power and frequency over this range as shown in the following figure.

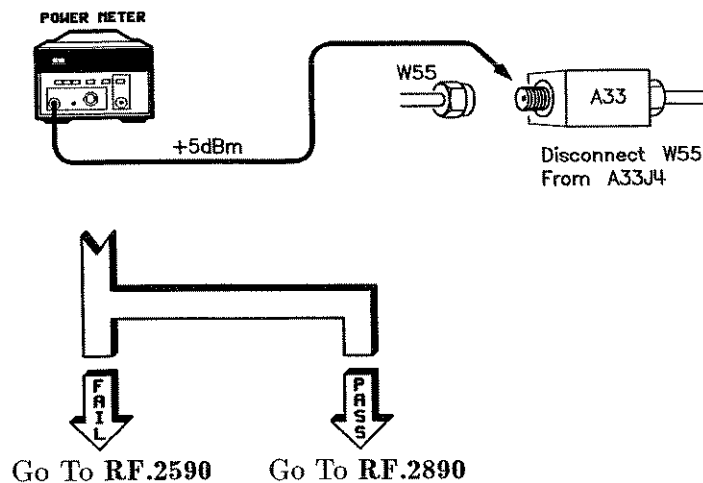

Special Cases Section

In SC.250, Block Diagram Notes, make the following changes:

1. In the second paragraph, change the third and fourth sentences to read:

“Beginning with the YO (A26), the signal is passed to the mod/splieer. A sampled portion of the mod/splitter output is fed back through W51, FL2, and W54 to the sampler (A6).”

2. Replace the fourth paragraph with the following one:

“The second ALC loop begins with the bridge detector in the HP 83621A/31A or the coupler/detector in the HP 83651A (A30). Like band 0, this signal goes to the ALC (A10) where it is compared to a reference. The difference between the reference and the detector output voltage is used as an error signal. This error signal is sent back to the mod/splitter (A25) where it is used to control the loop gain. And, finally, the level-corrected signal out of the mod/splitter (A25) is amplified (A29), frequency multiplied, and filtered (A28).”

Change A

HP 83621A/31A instruments with serial prefix 3137A and lower use a DC blocking capacitor (A36) and a coupler/detector rather than the bridge detector (A30). Make the following changes to the "Troubleshooting" manual:

Instrument-Level Troubleshooting Section

1. In the following paragraphs, replace the words "bridge detector" with "coupler/detector":
 ILT.2255
 ILT.2256
 ILT.2257
2. In paragraph ILT.2255, add the following as item 10:
 The DC blocking capacitor (RF.3690) – HP 83621A/31A only.

RF Section

1. Replace RF.3090 with the following:
 The detector, (CR1, part of A30) has failed. Replace it and its bias board together. The directional coupler rarely fails, however replace it at this time also *only* if it has failed.
2. Add the following:
 RF.3690
 Replace the DC blocking cap, A36, using the disassembly and replacement procedures. Perform the appropriate adjustments and restart troubleshooting.

System Section

Rewrite item 3 in paragraph SYS.606 to read as follows:
"Remove the hard line which connects to the input of the coupler/detector (A30)."

Special Cases Section

In the last paragraph of SC.230, delete the reference to the HP 83651A. This information applies to all models.

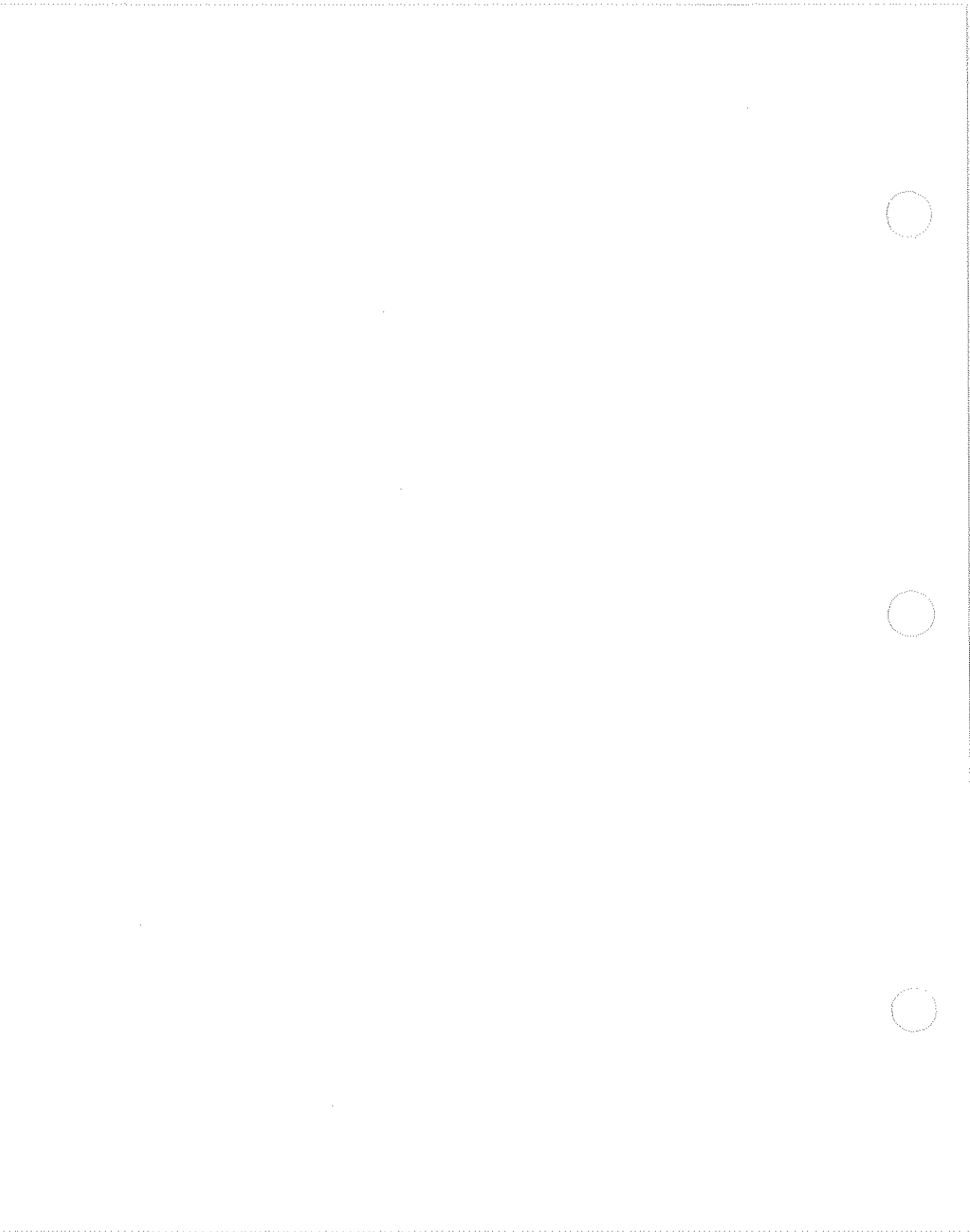

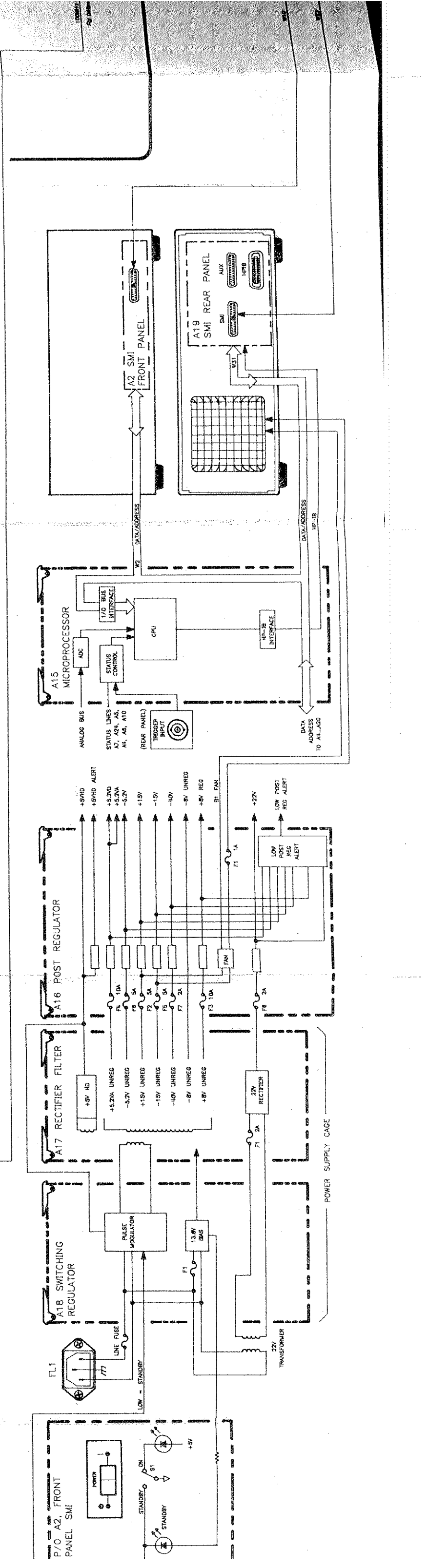
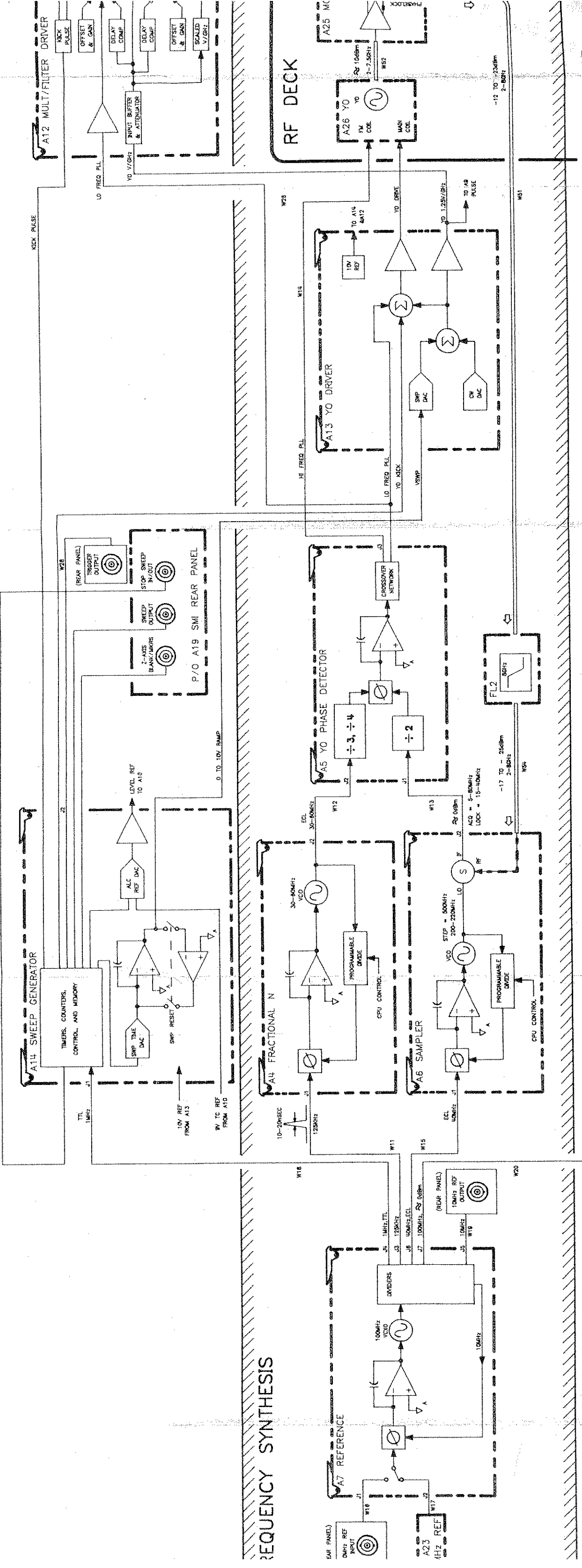

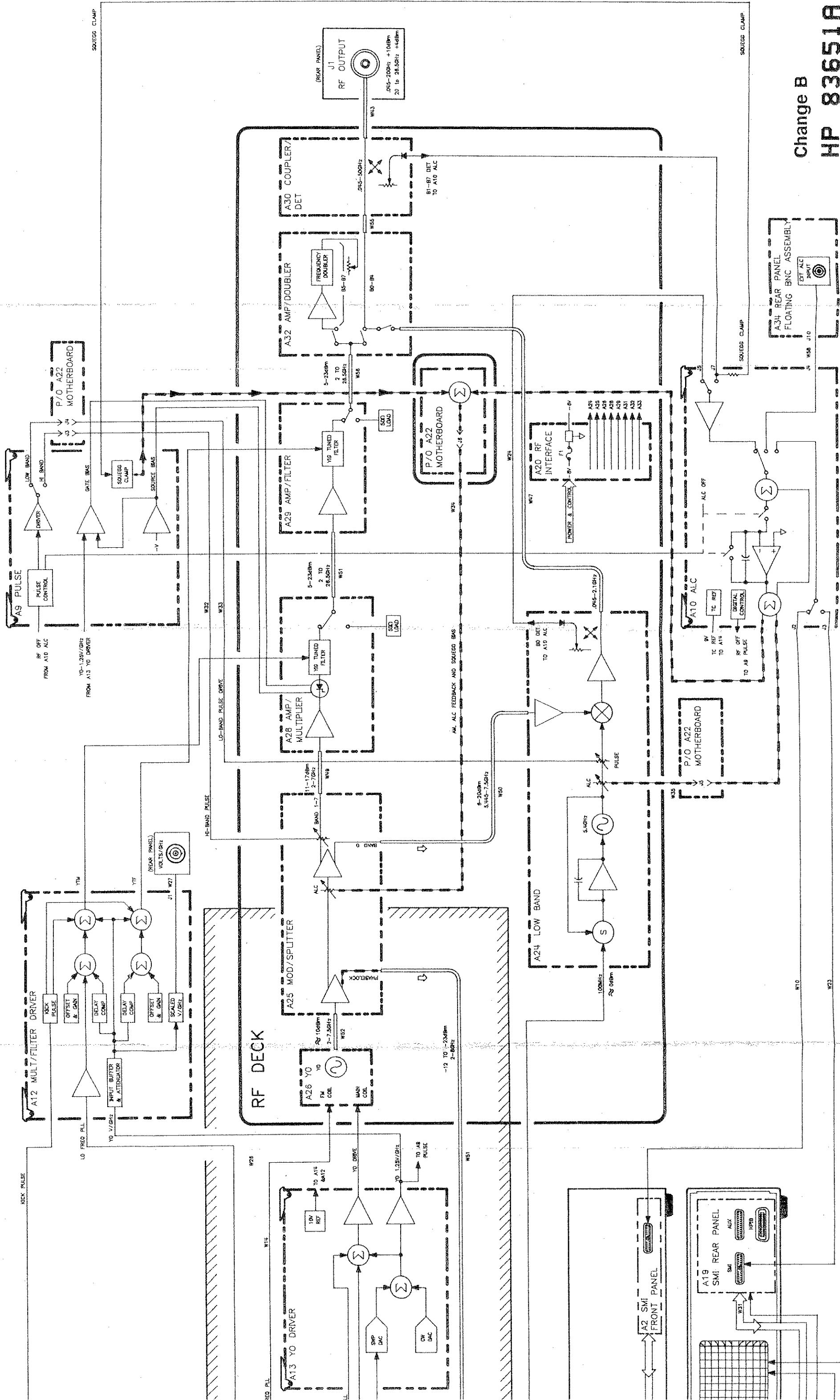

Change B
HP 83651A

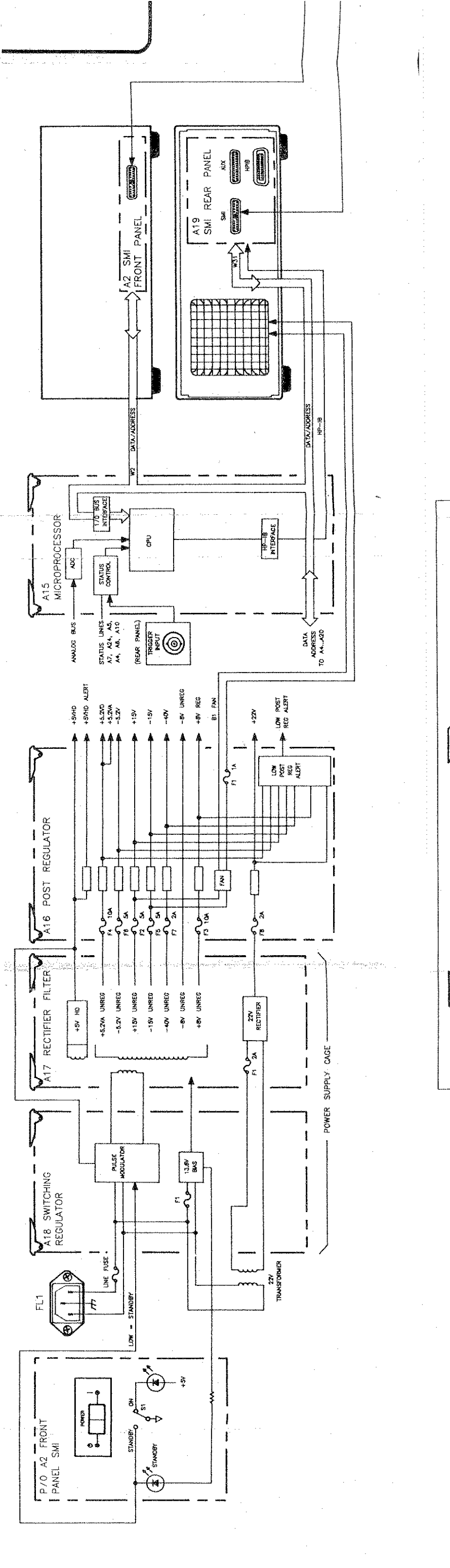
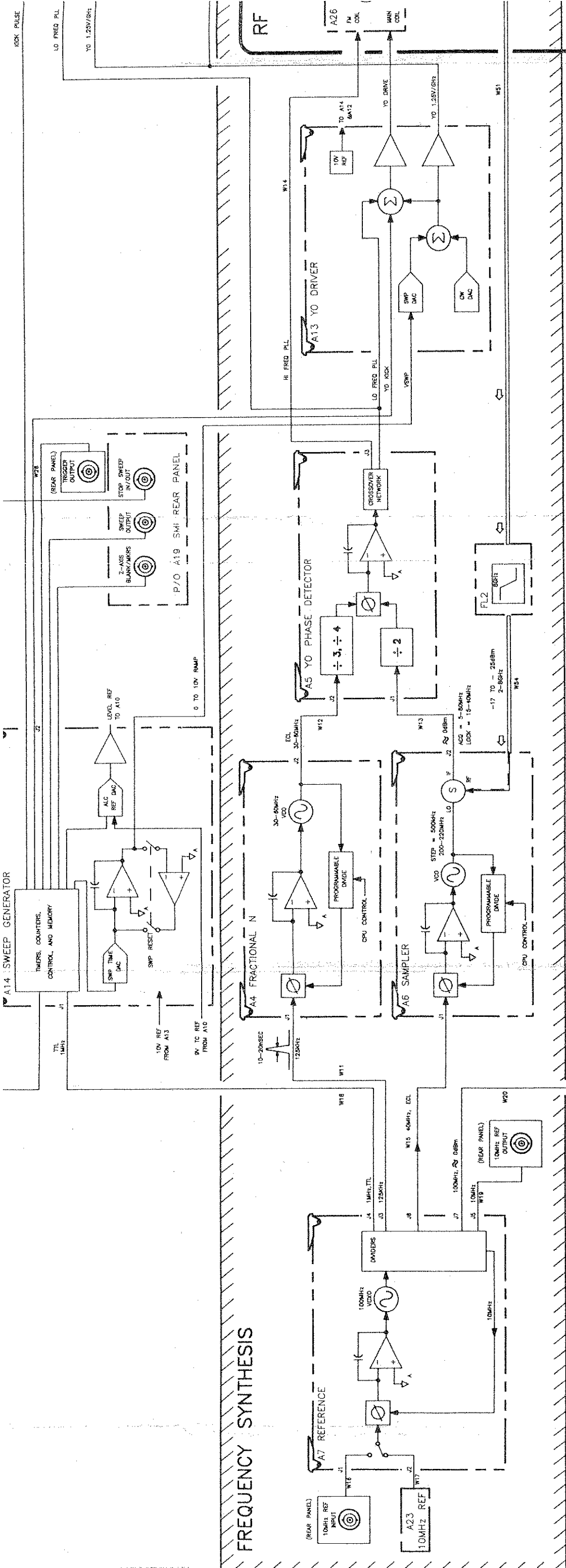

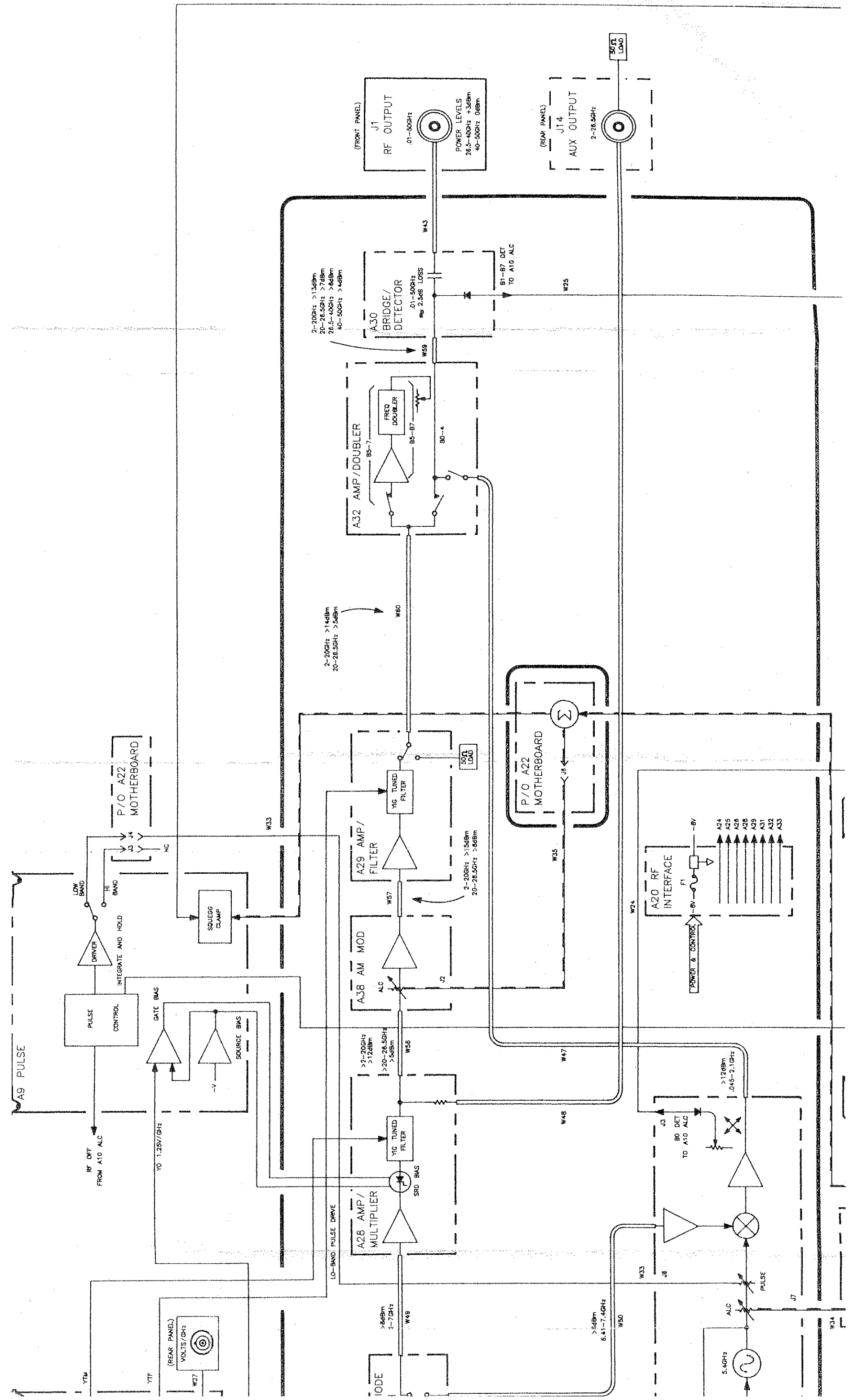

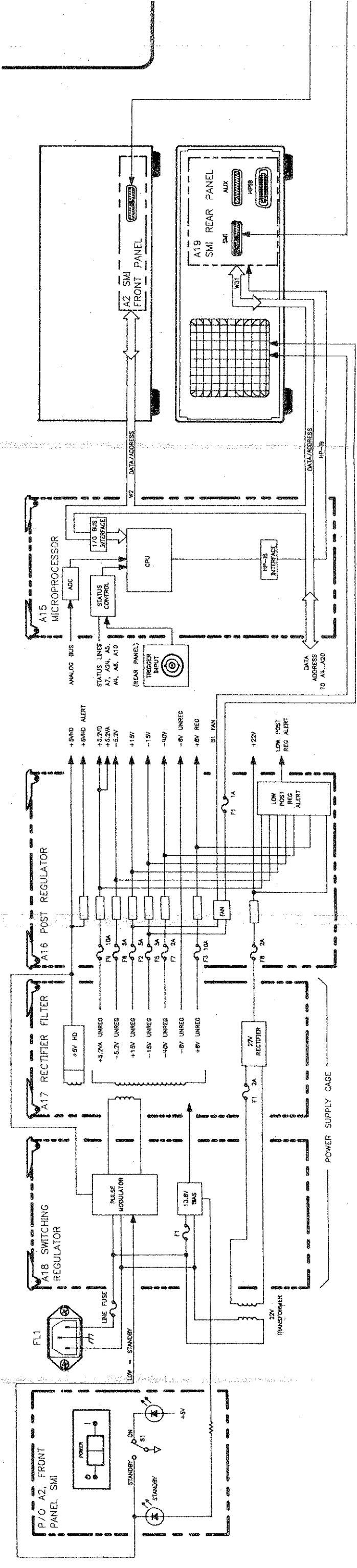
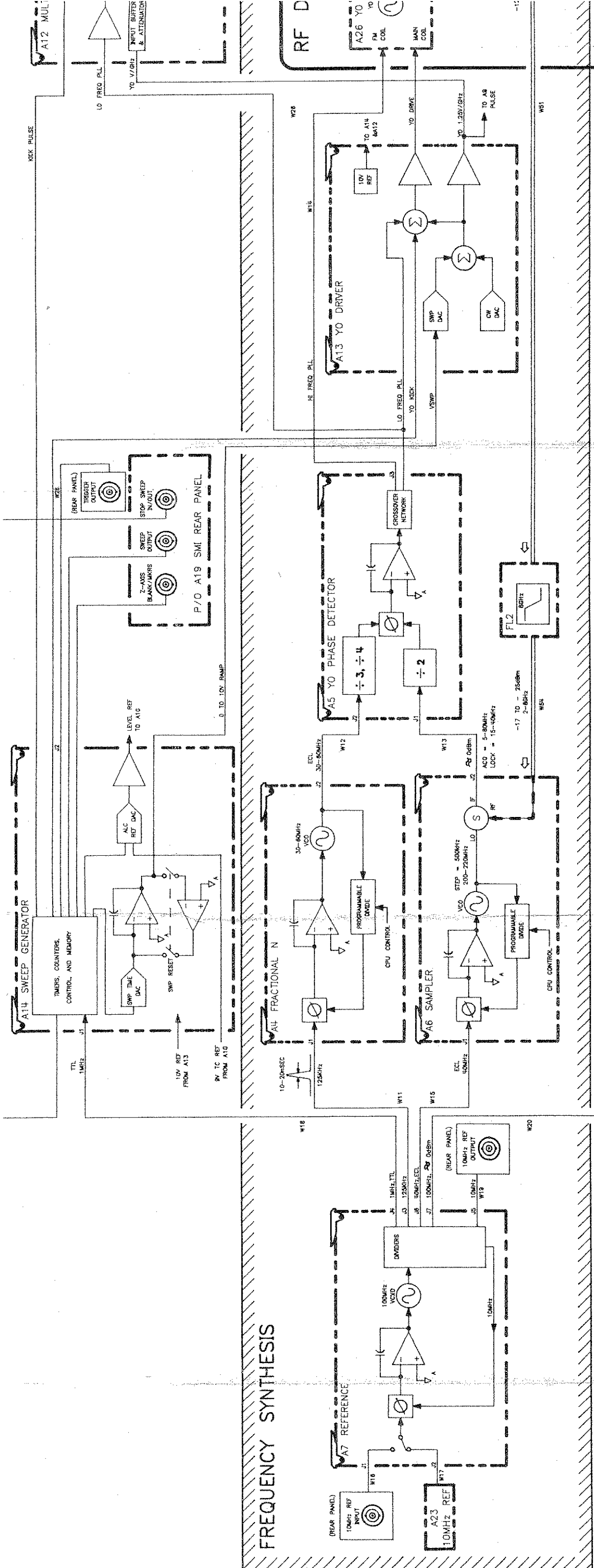

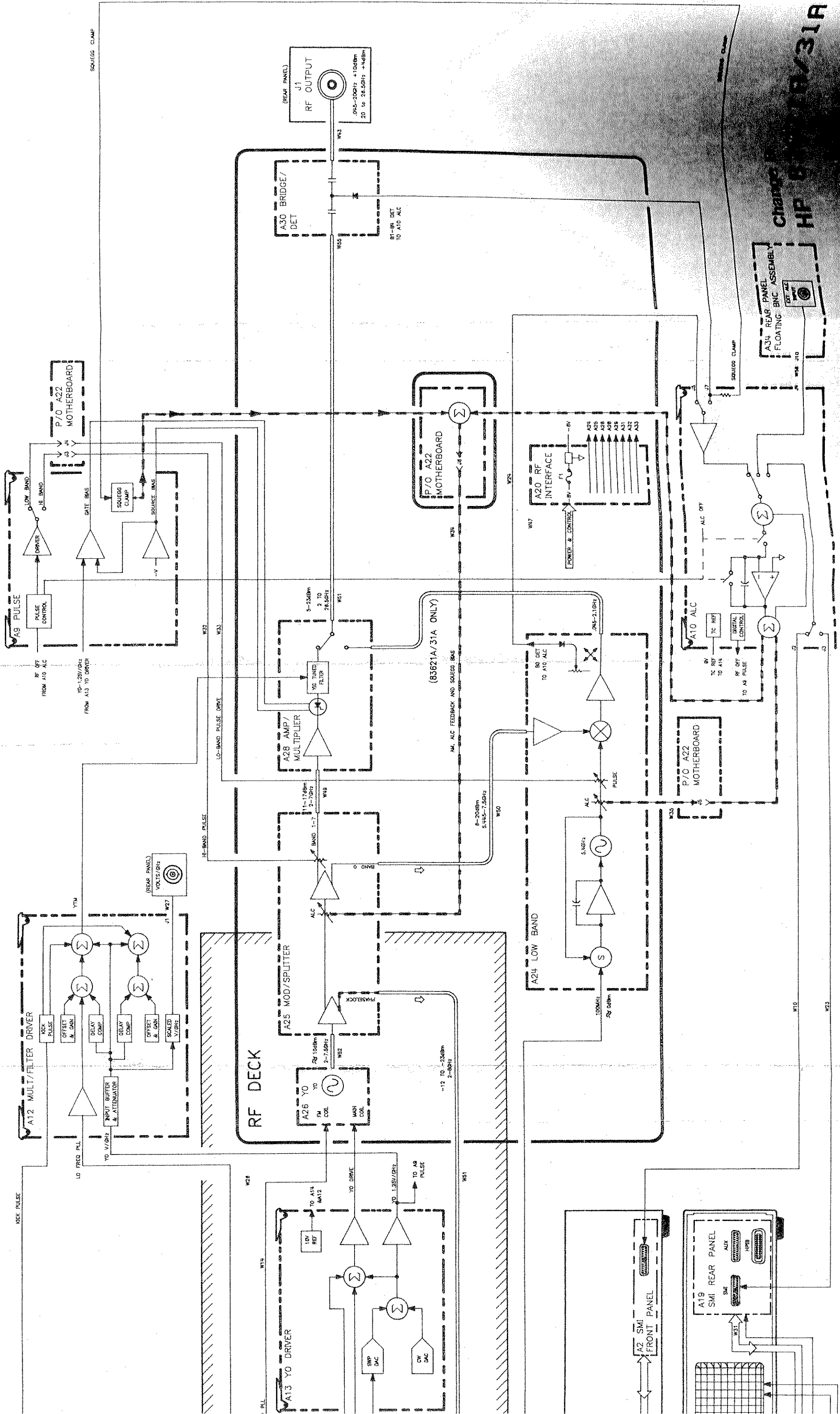

HP 83621A/31A

